











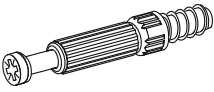
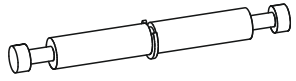

A1 8 x 35 mm x8 	A2 8 x 45 mm x12 	C2 5 x 13 mm x6 
E1 15 x 12 mm x26 	F1 6 x 34 mm x4 	F3 7 x 64 mm x11 
G2 7 x 60 mm x3 	I12 4 x 27 mm x6 	I13 4 x 30 mm x3 
I16 4 x 45 mm x3 	M x1 	P1 x3 
W1 x1 	W2 x3 	Y2 x3  Ø10

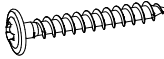

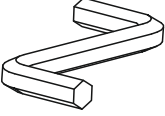

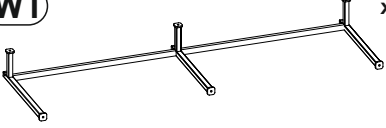
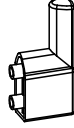
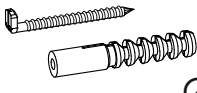
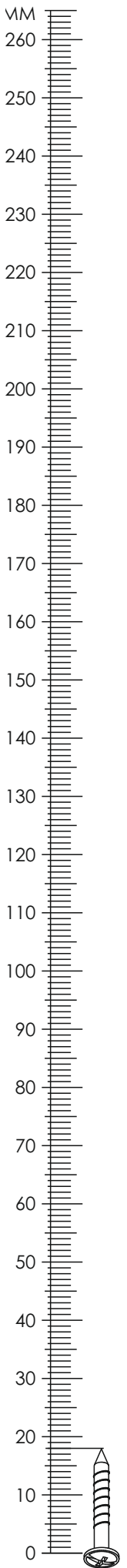
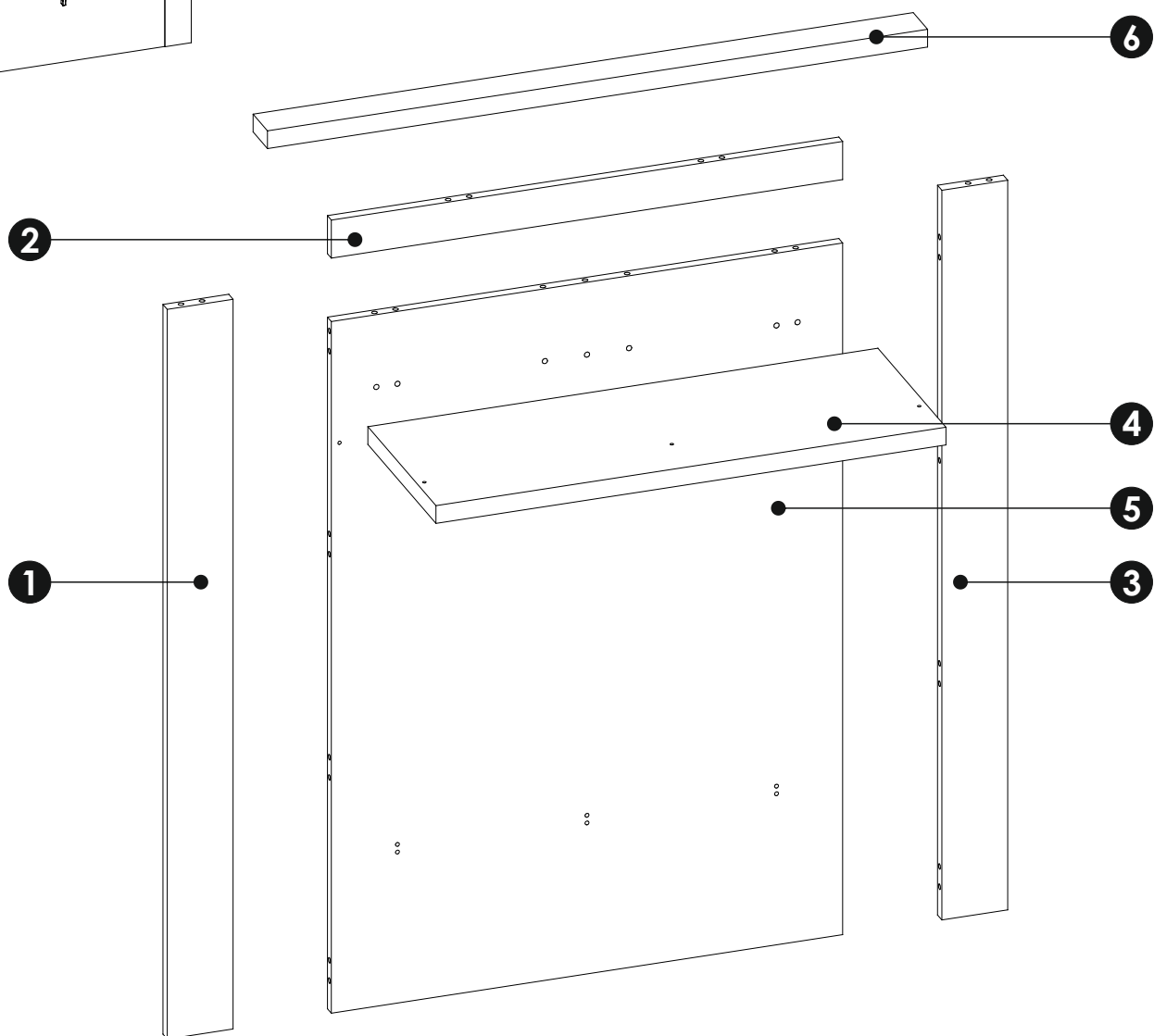
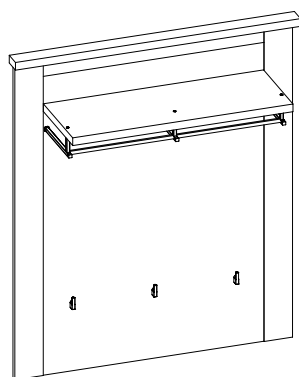
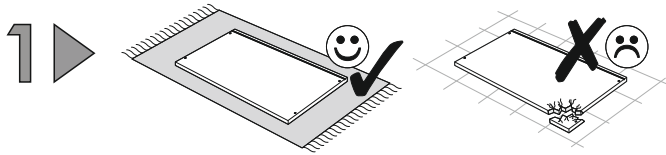
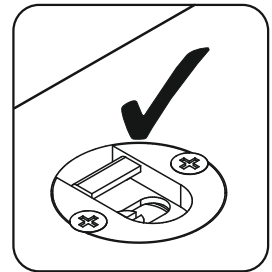
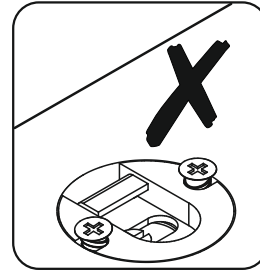
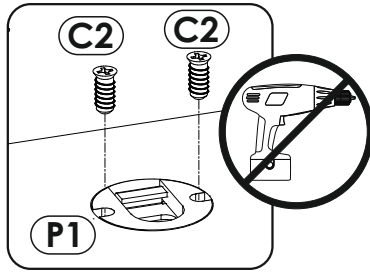
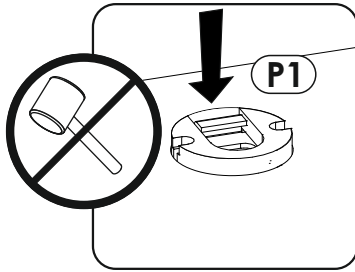
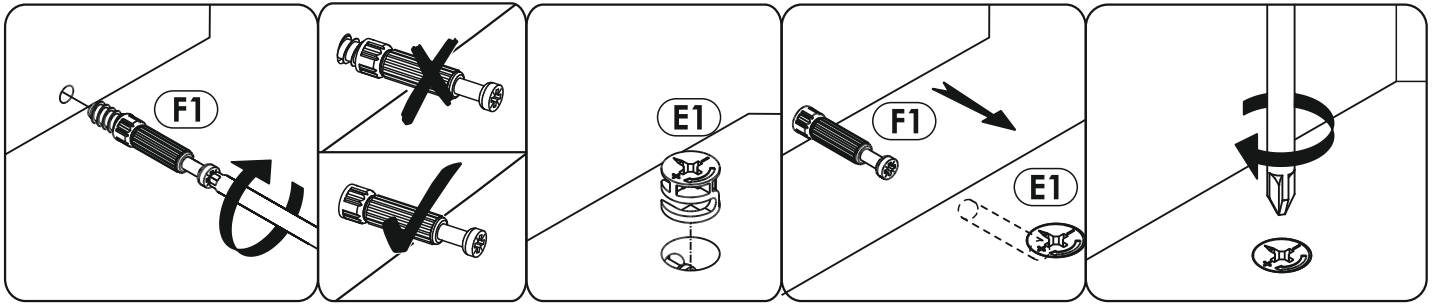
1	1150	100	18	x1	1/1
2	777	60	16	x1	1/1
3	1150	100	18	x1	1/1
4	775	284	28	x1	1/1
5	1090	777	16	x1	1/1
6	1003	60	28	x1	1/1

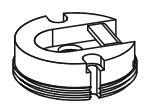

(C2)	x2	(E1)	x11	(P1)	x1
					
5 x 13 mm		15 x 12 mm			

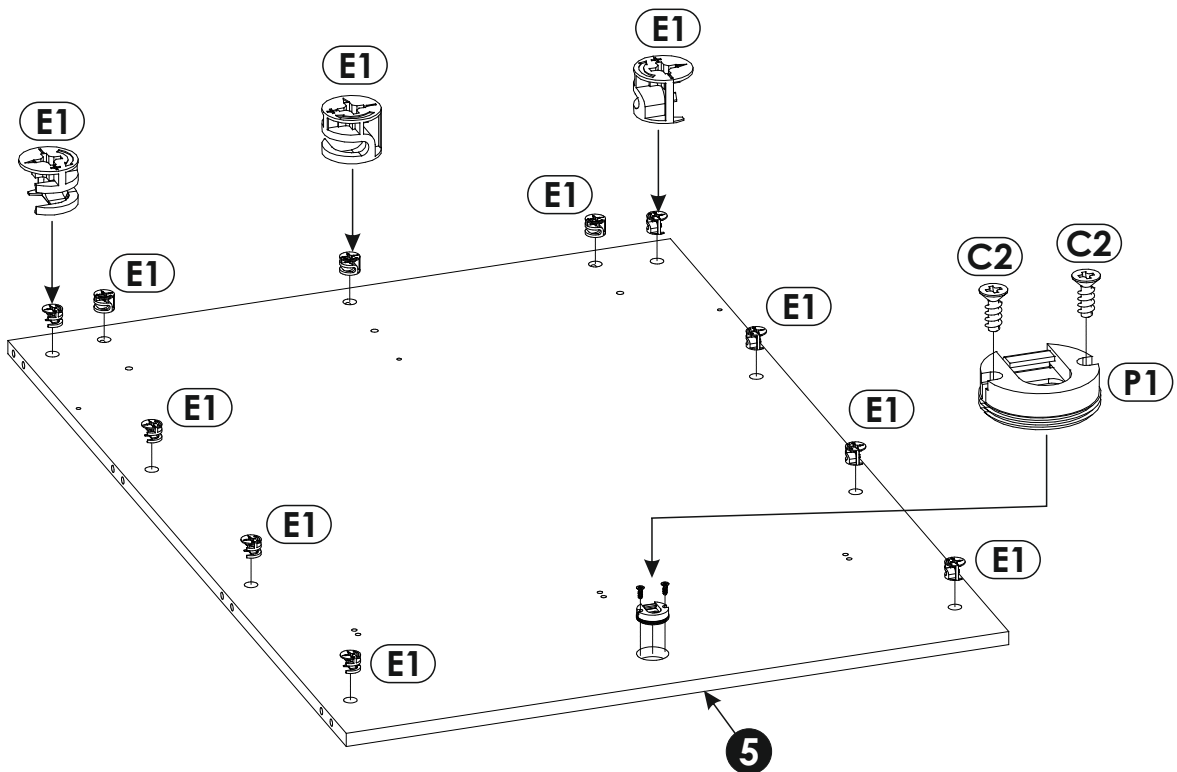

2

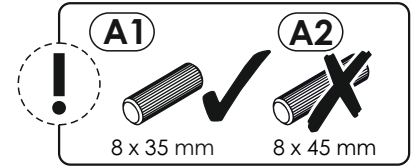
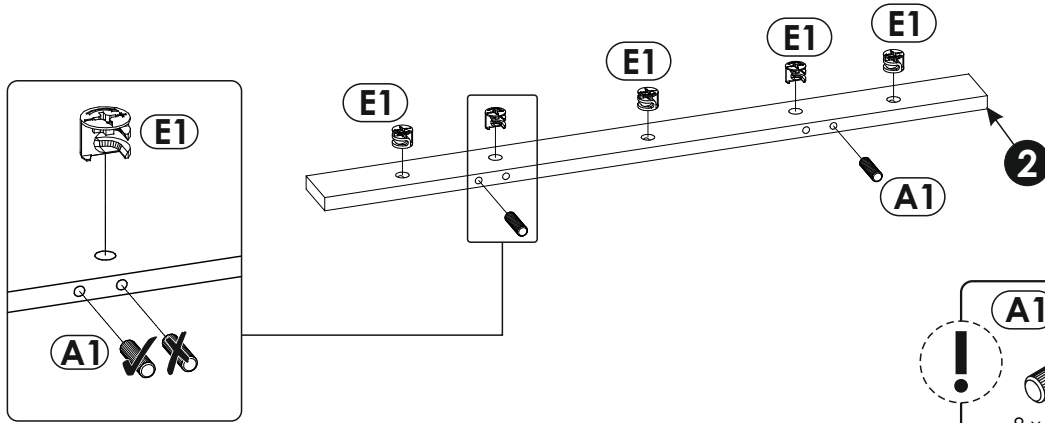
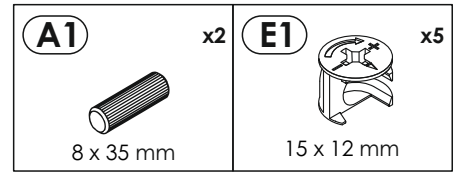
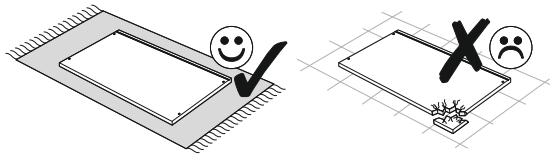

3

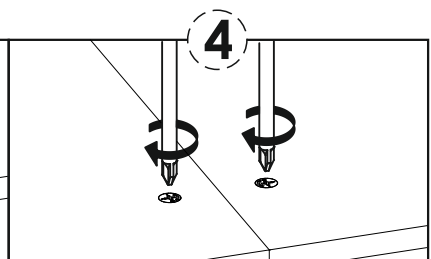
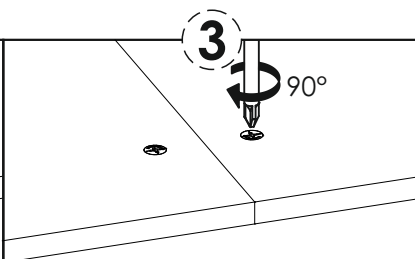
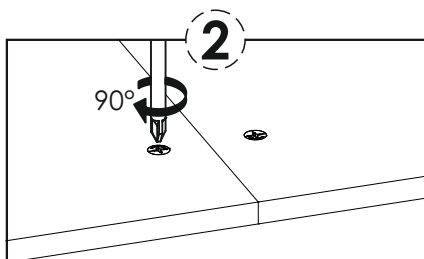
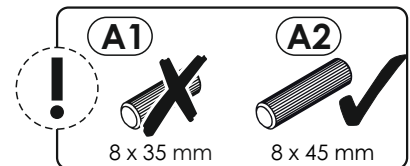
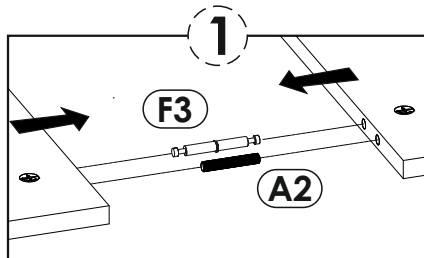
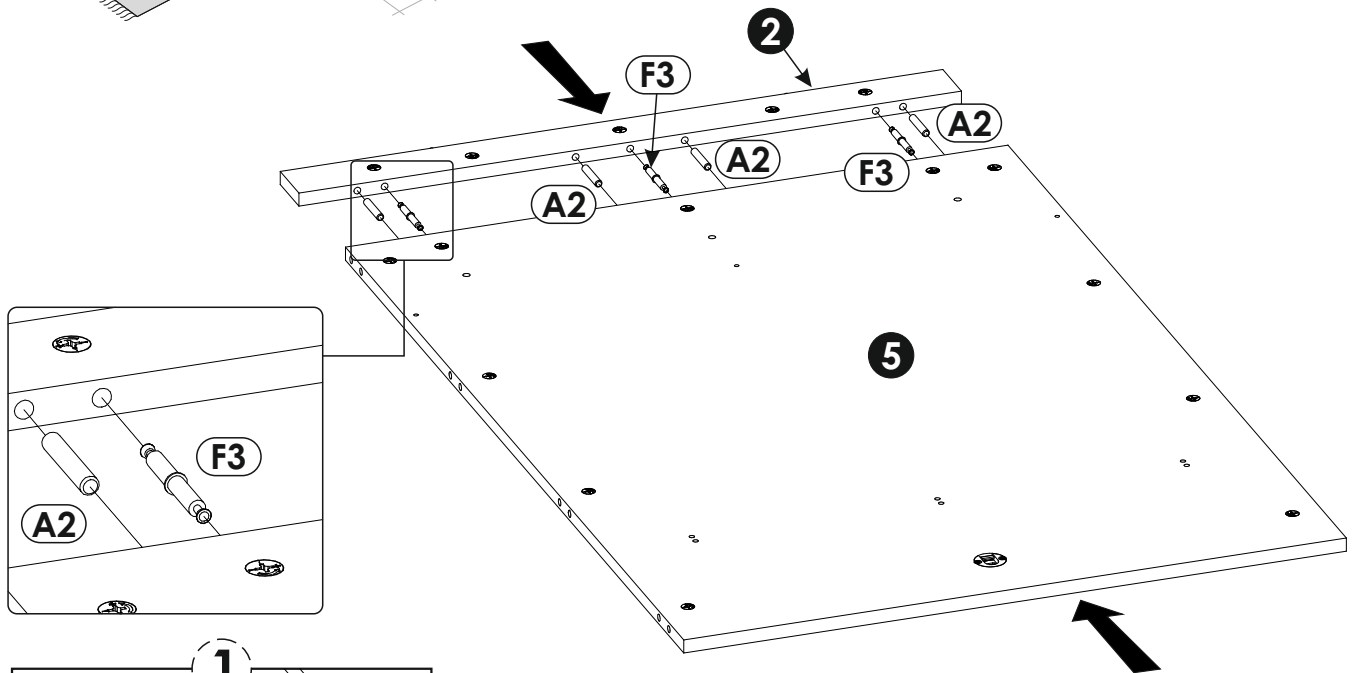
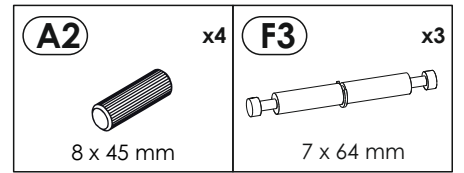
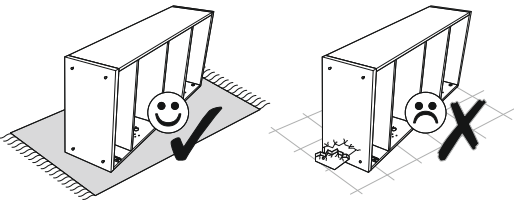

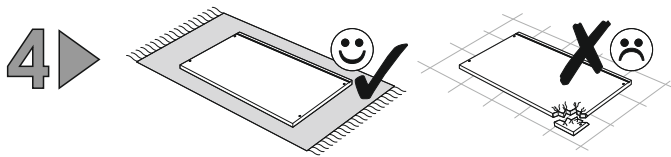

A1 x2 8 x 35 mm	C2 x4 5 x 13 mm	E1 x10 15 x 12 mm
P1 x2		

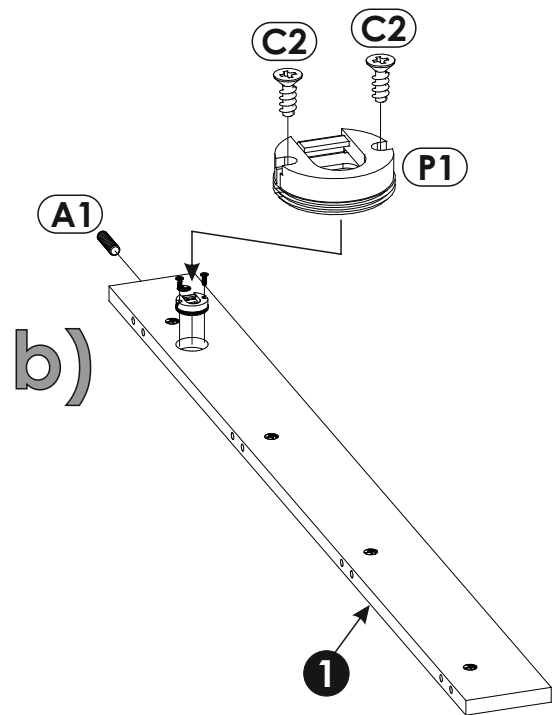
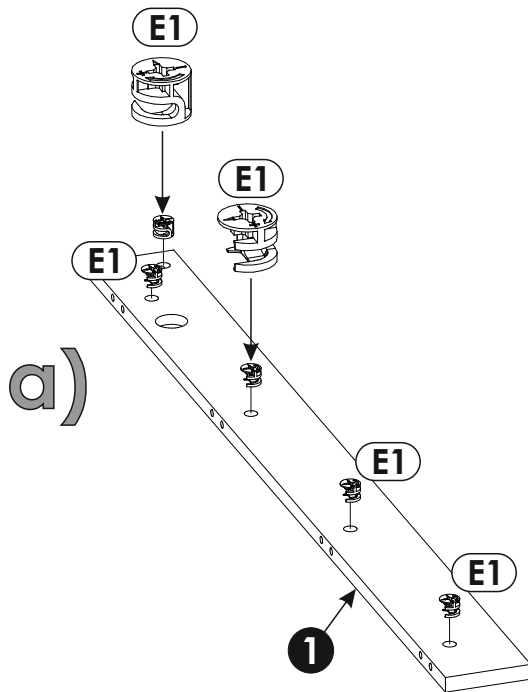
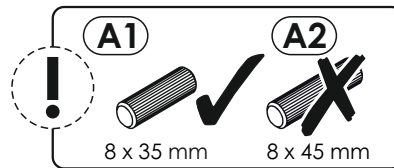
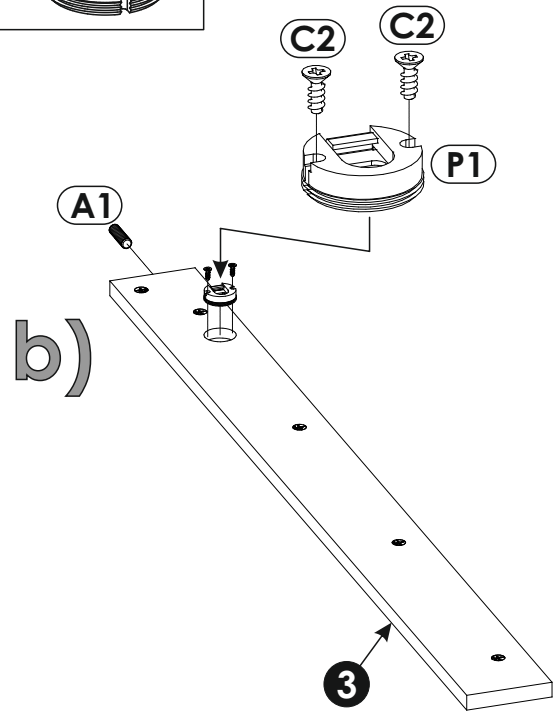
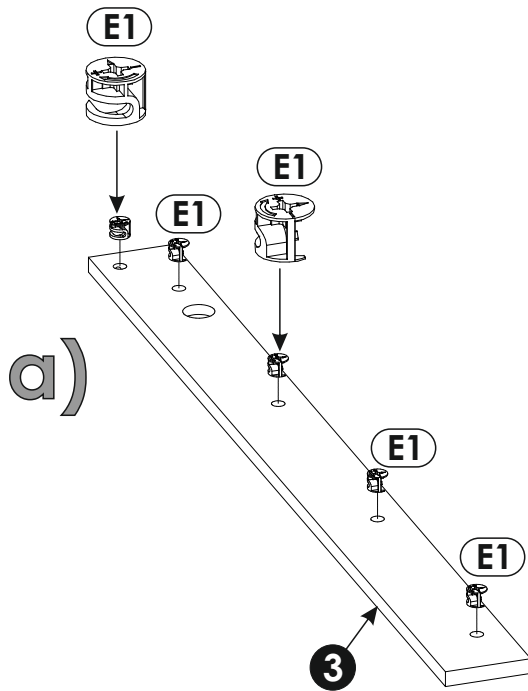

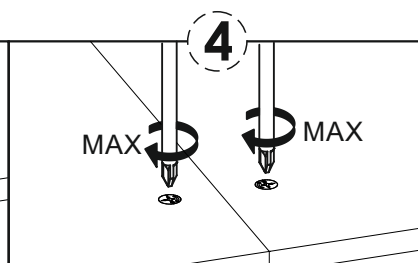
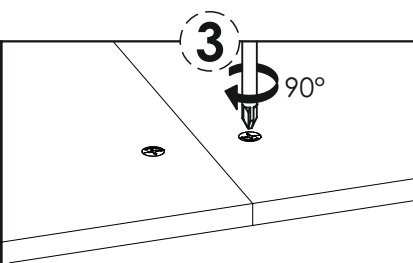
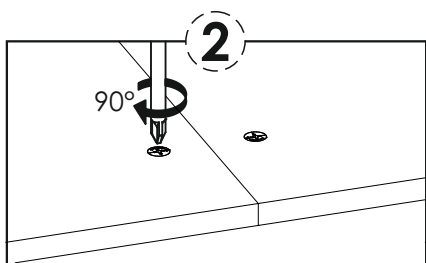
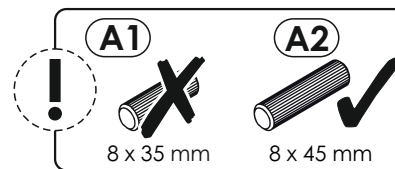
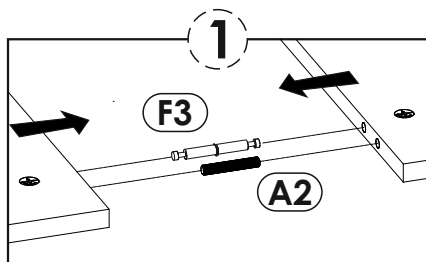
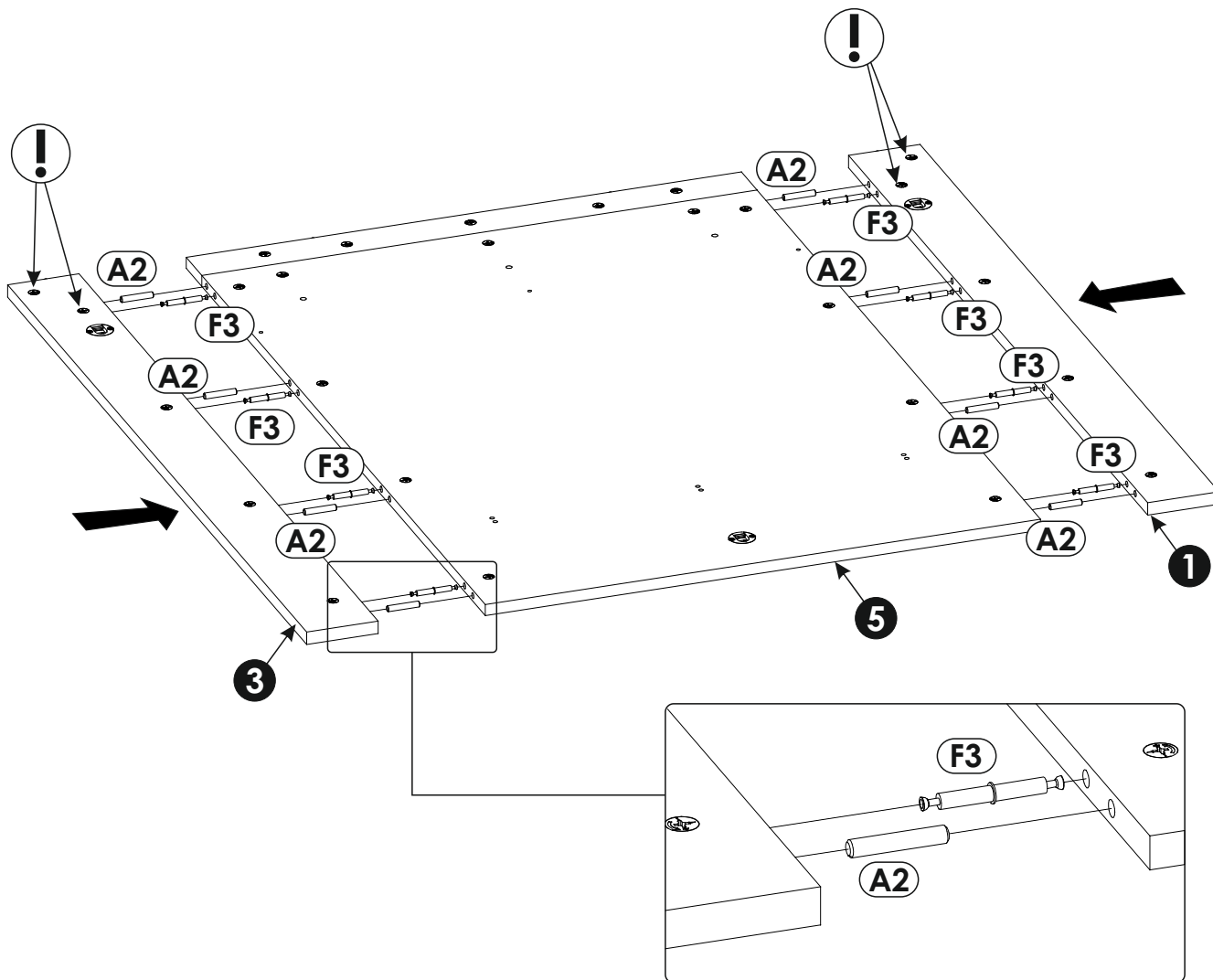
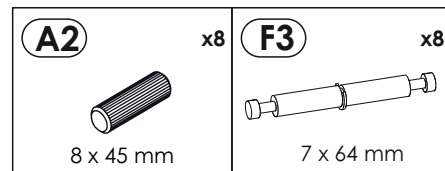
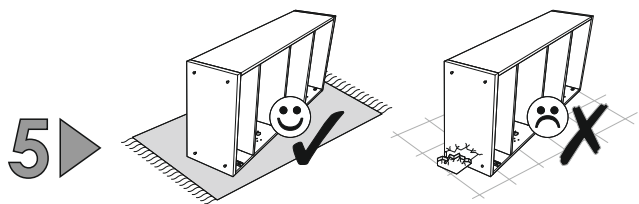

6 ▶

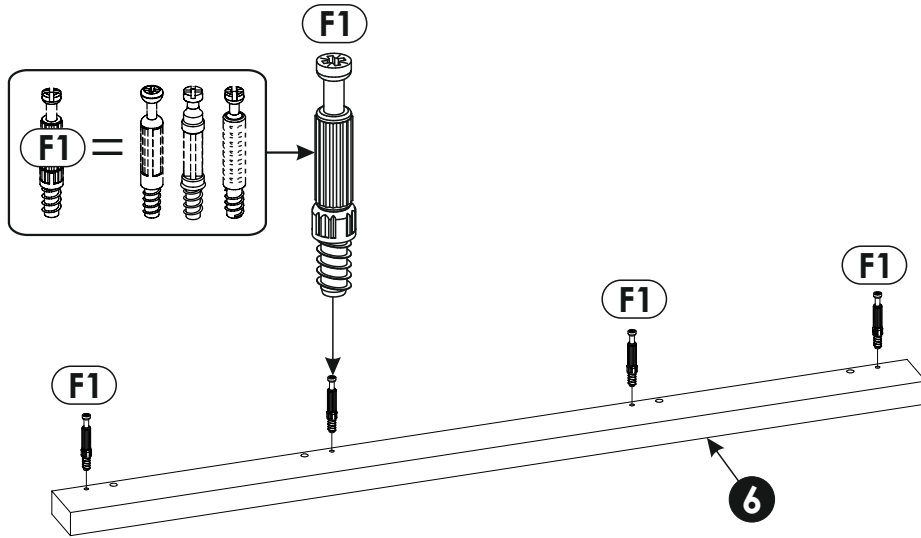
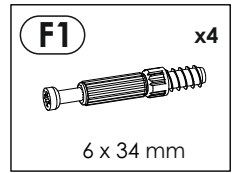
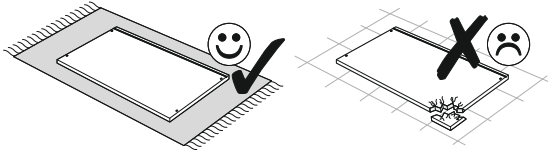

7 ▶

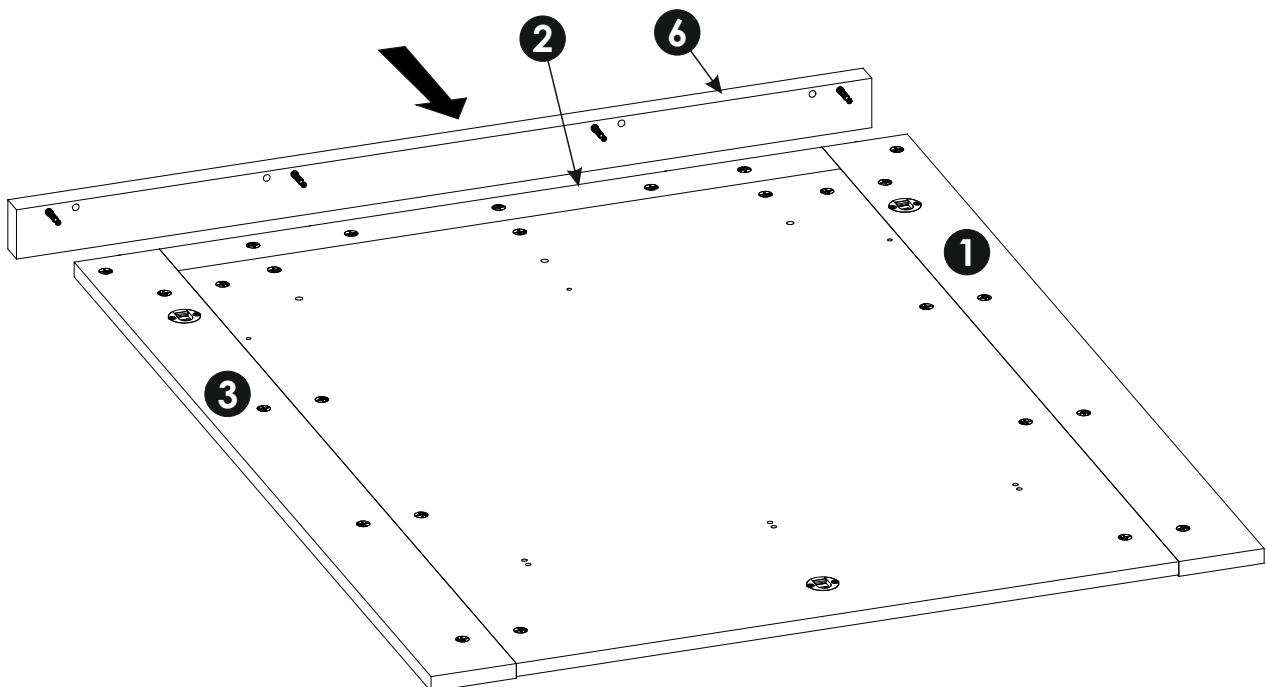
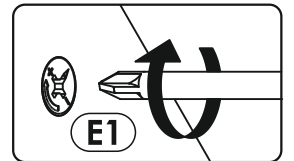
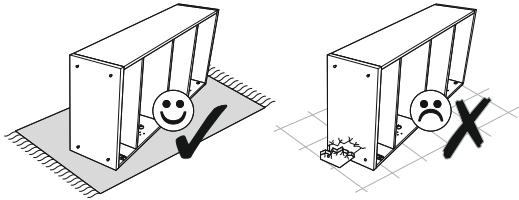

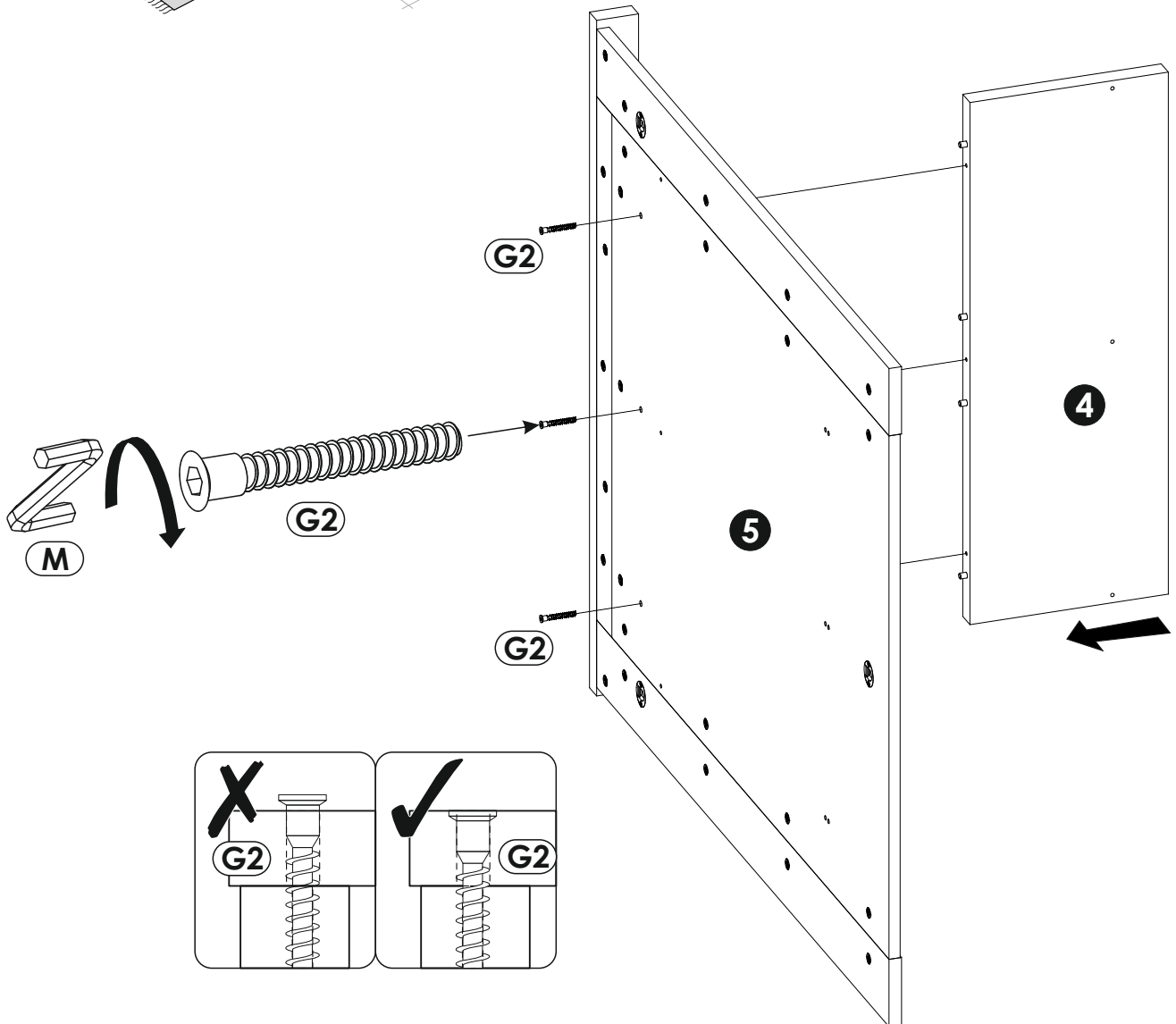
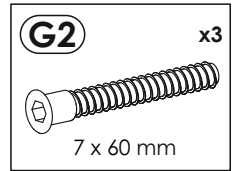
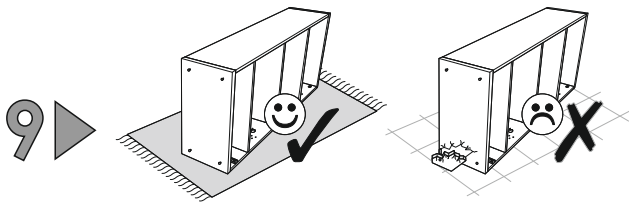
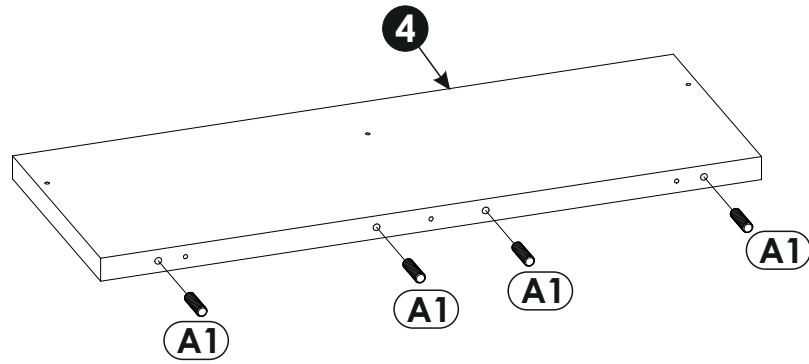
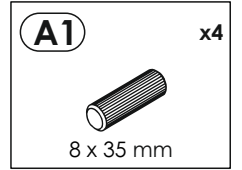
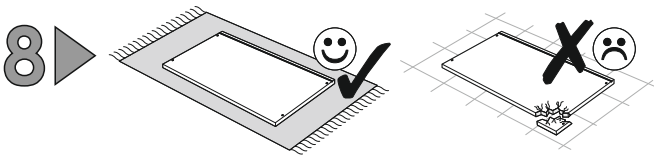

10 ▶

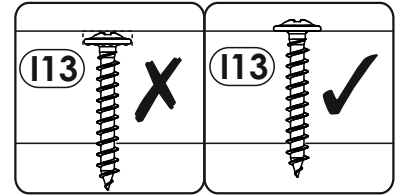
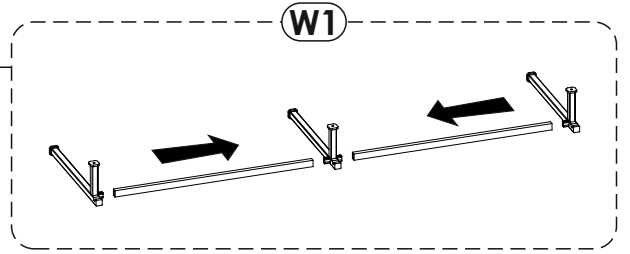
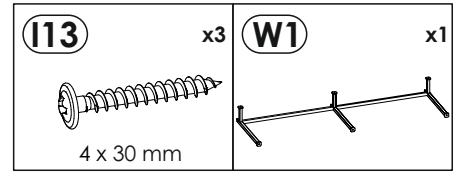
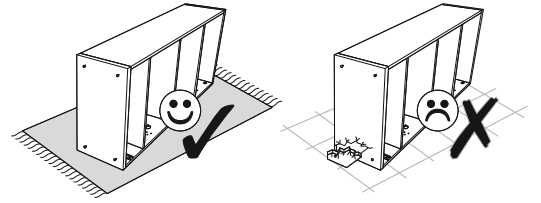
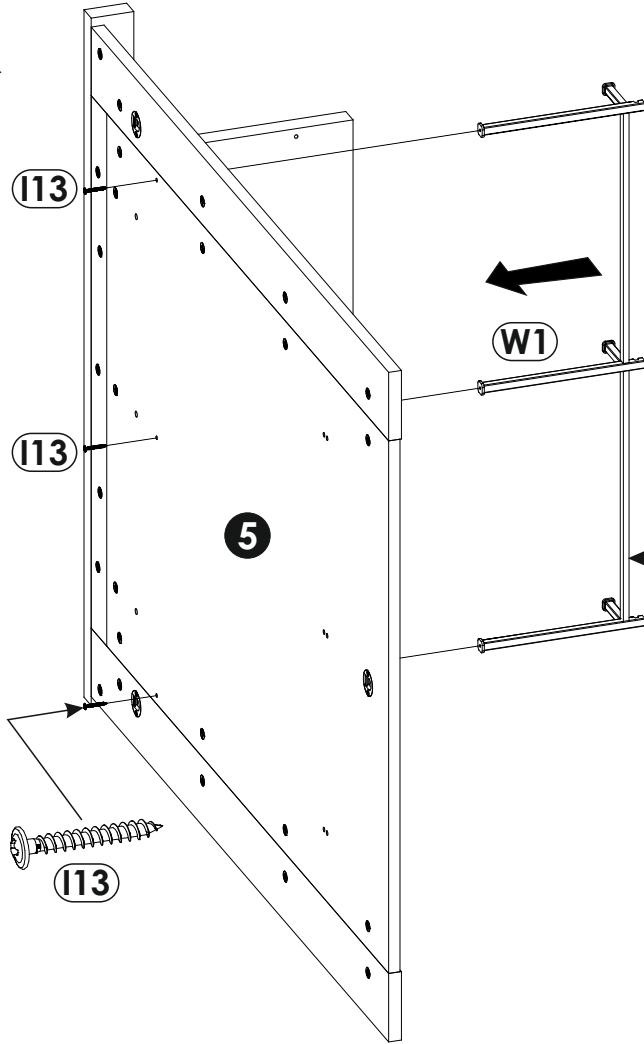

11 ▶

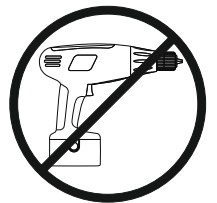
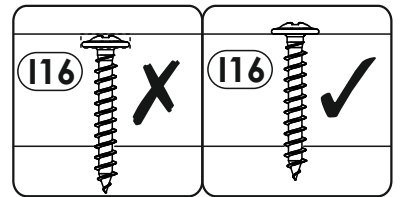
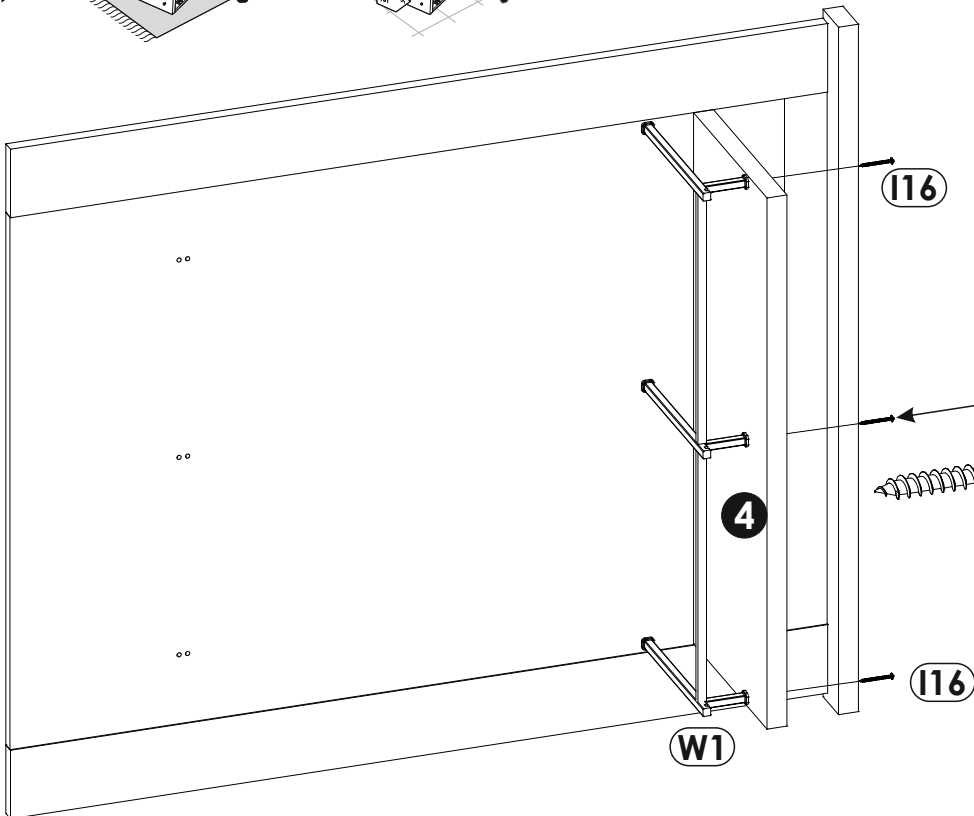
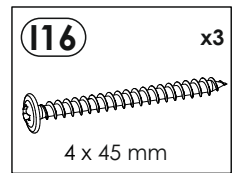
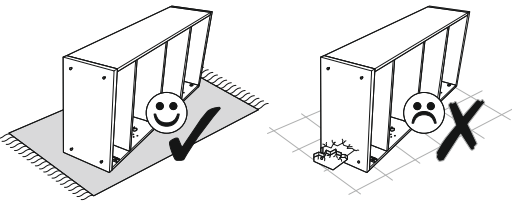

12 ▶

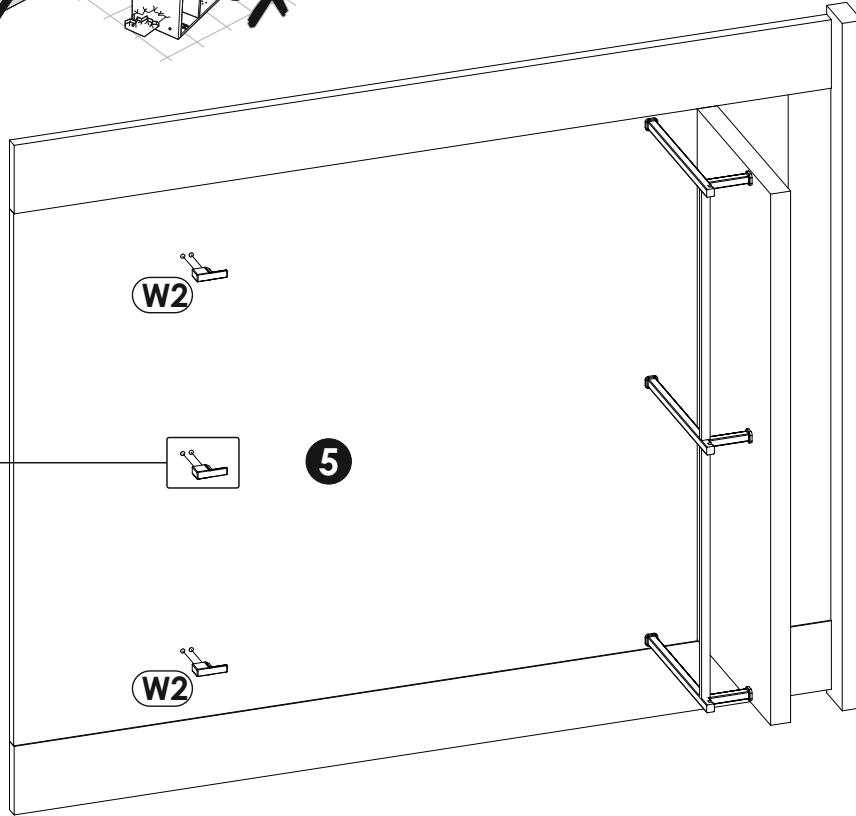
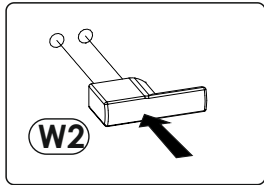
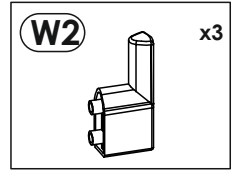
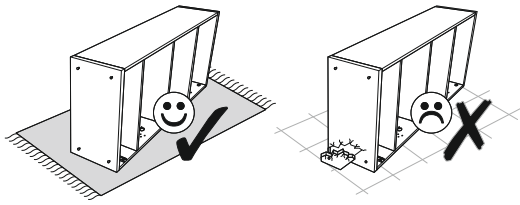

13 ▶

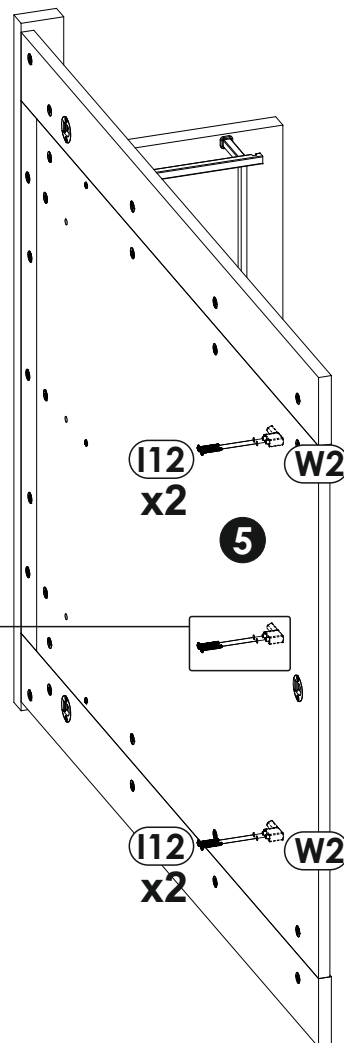
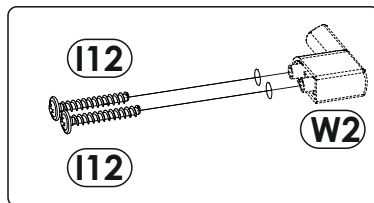
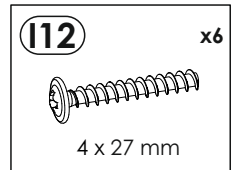
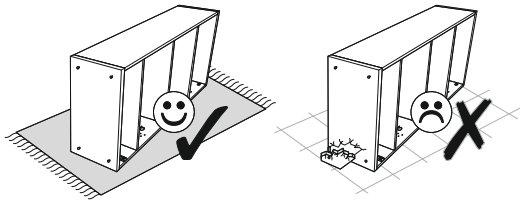

14 ▶

