

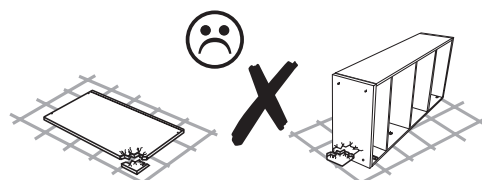

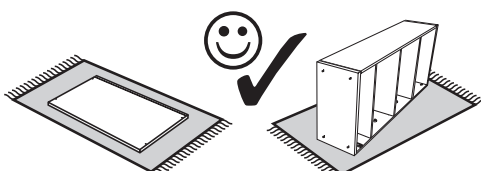

2019-06-26

 0,5 h

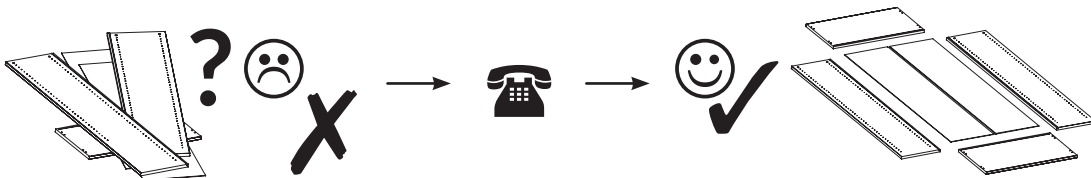
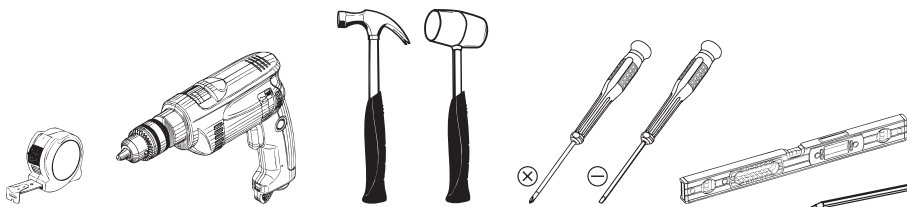
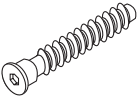

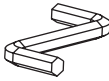

| | | | | |
|--|---|---|--|---|
| A  7 x 50 mm x 5 | S3  x 2 | T2  5 x 10 mm x 4 | V4  Ø 35 x 2 | XA  x 1 |
|--|---|---|--|---|

| nr | ↔ [mm] | ↓ [mm] | ∠ [mm] | Menge | Colli |
|-----|--------|--------|--------|-------|-------|
| J-1 | 1380 | 200 | 16 | x 1 | 1/1 |
| J-2 | 1370 | 184 | 16 | x 1 | 1/1 |

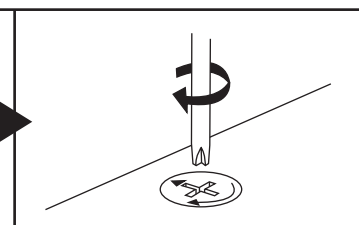
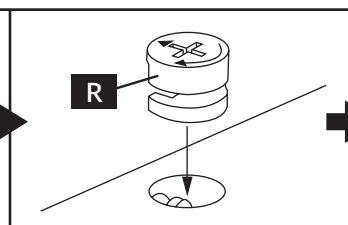
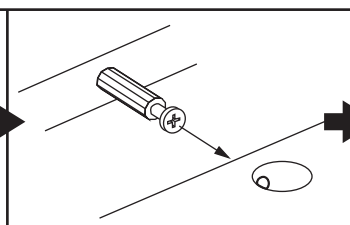
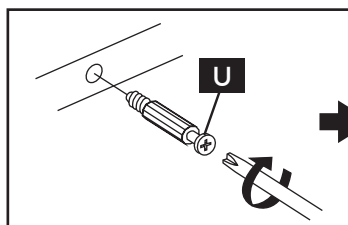
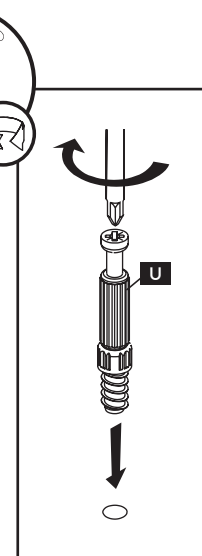
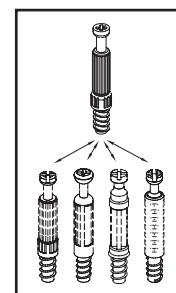
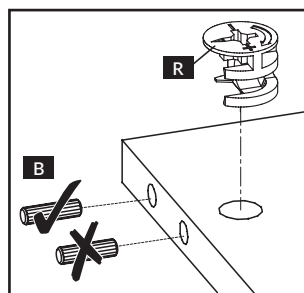
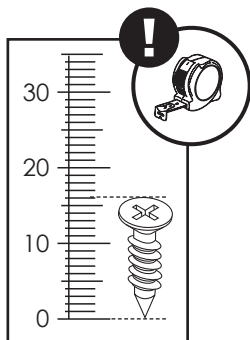
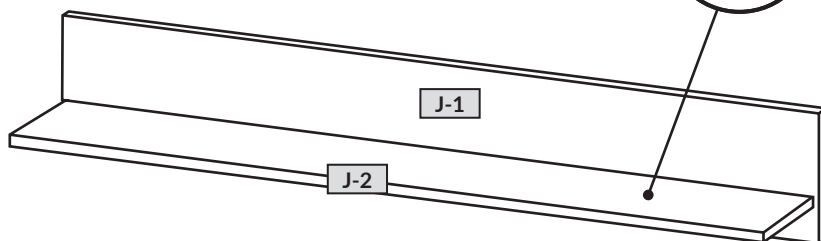
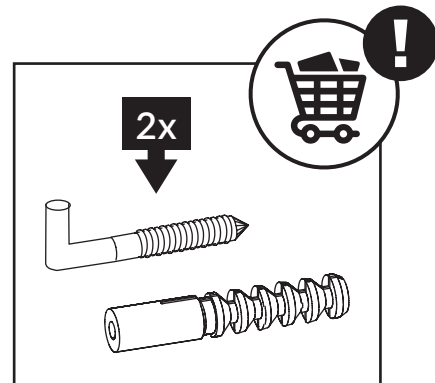



1

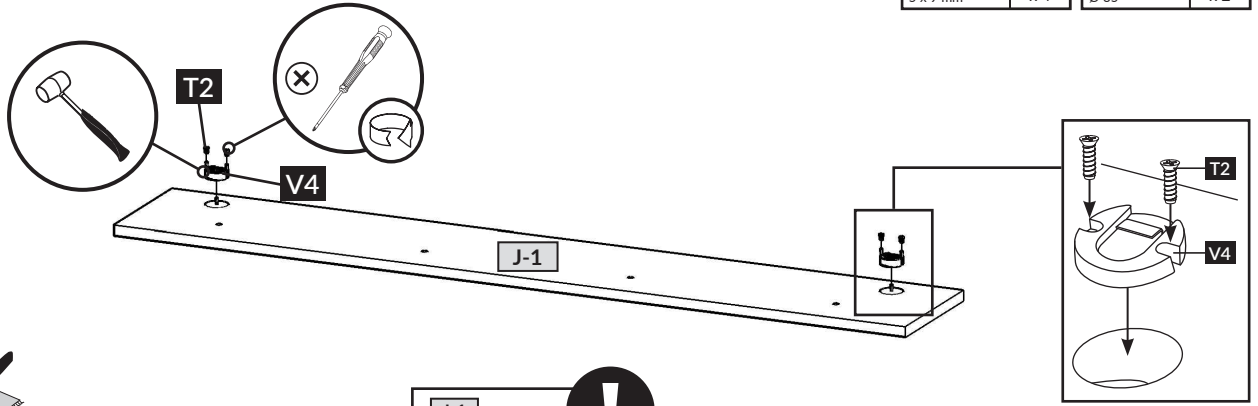
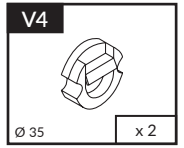
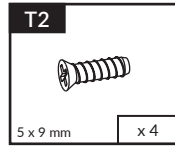

2

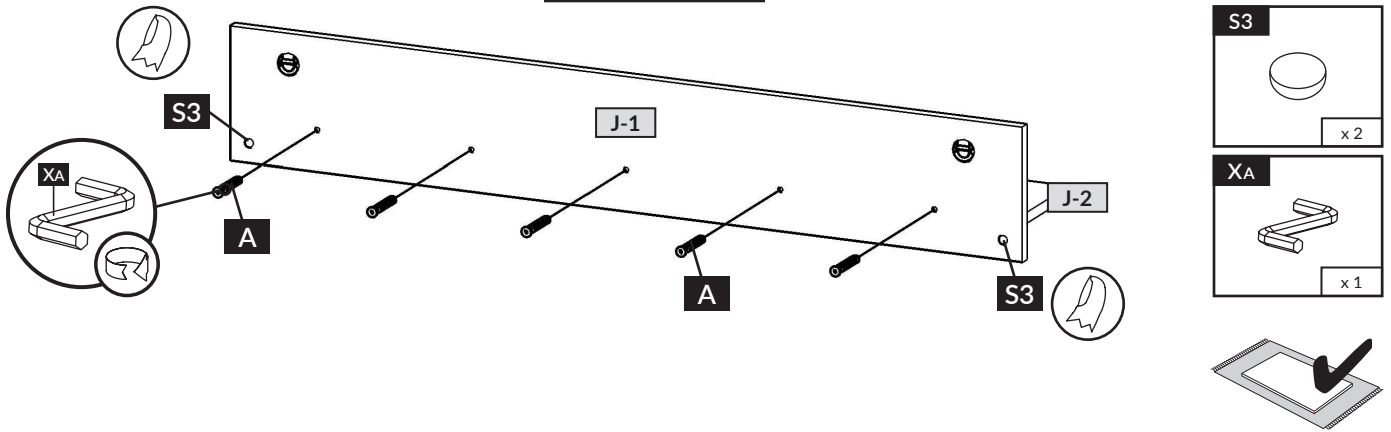
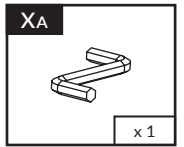
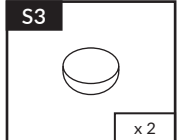
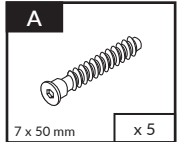
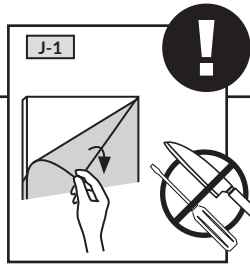

3

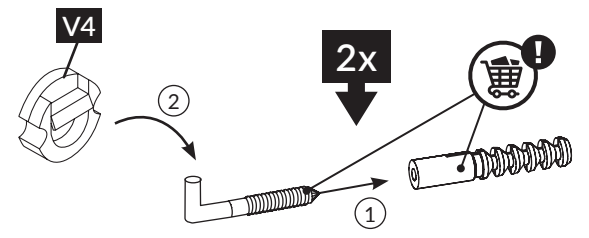
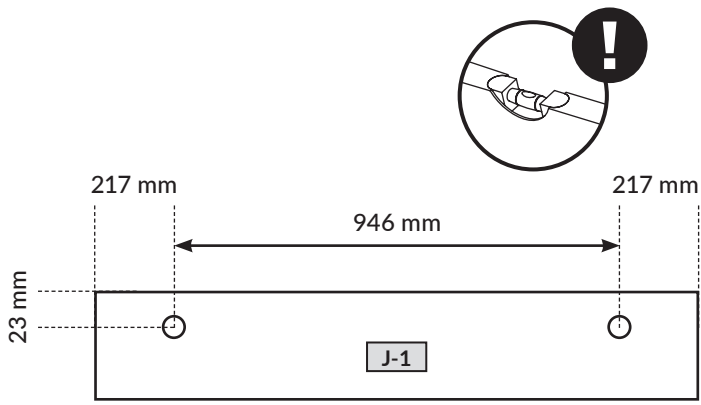
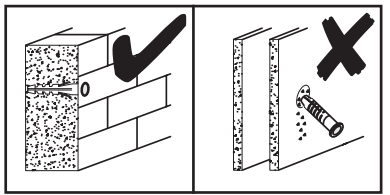

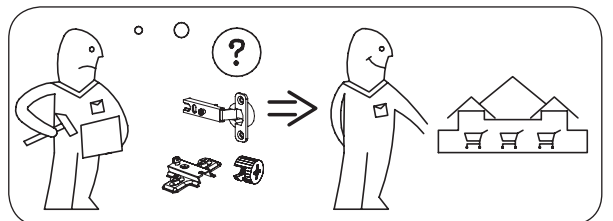
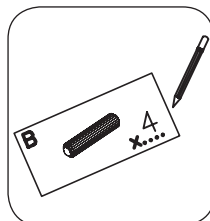
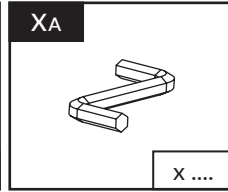
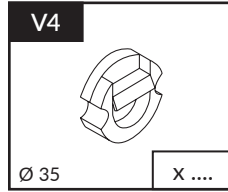
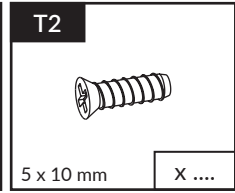
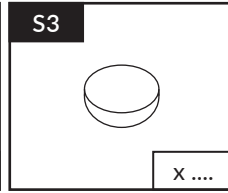
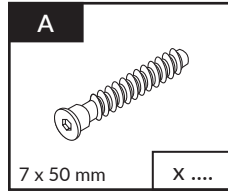

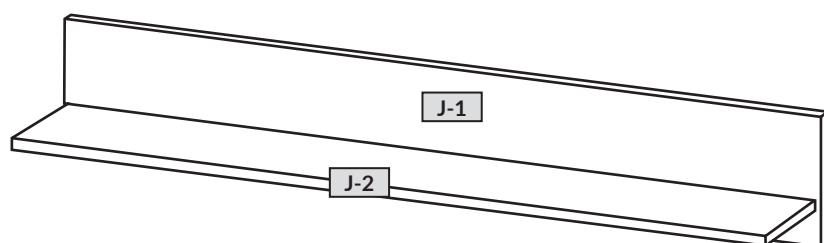

| nr | ↔ [mm] | ↕ [mm] | ∅ [mm] | Menge | Colli |
|-----|--------|--------|--------|-------|-------|
| J-1 | 1380 | 200 | 16 | x 1 | 1/1 |
| J-2 | 1370 | 184 | 16 | x 1 | 1/1 |

