

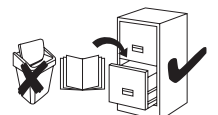

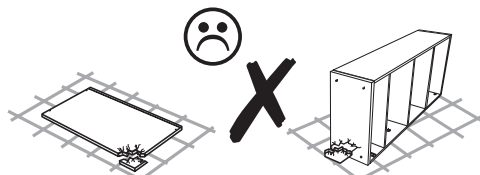

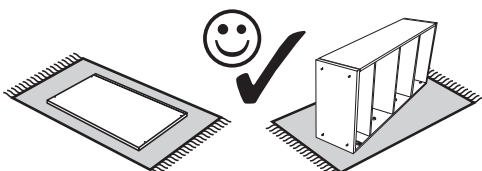

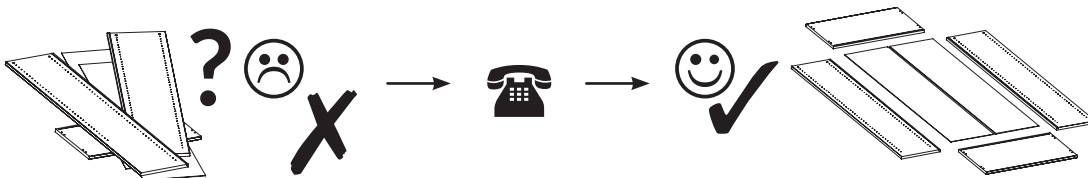

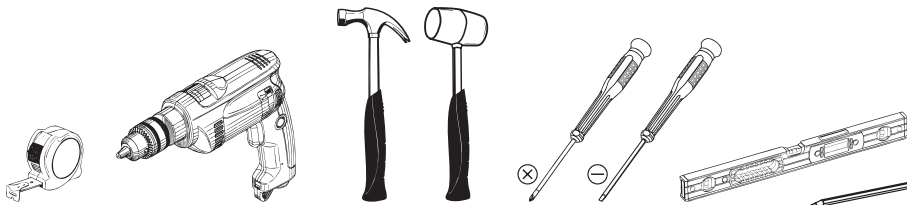
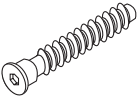

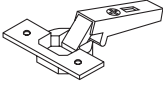
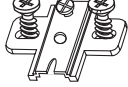
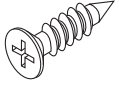
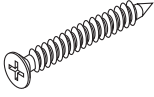
2019-08-13



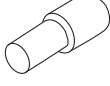
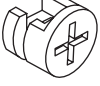
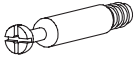
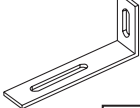
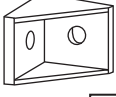

<p>A</p>  <p>7 x 50 mm x 4</p>	<p>B</p>  <p>8 x 32 mm x 30</p>	<p>B3</p>  <p>8 x 50 mm x 4</p>	<p>C</p>  <p>(CD) x 2</p>	<p>DT</p>  <p>x 2</p>	<p>E</p>  <p>3,5 x 13 mm x 9</p>
<p>E2</p>  <p>3 x 20 mm x 8</p>	<p>G2</p>  <p>x 4</p>	<p>H1</p>  <p>x 12</p>	<p>HDF</p>  <p>1151 / 100 mm x 1</p>	<p>P2</p>  <p>x 8</p>	<p>R</p>  <p>H=11 mm x 16</p>
<p>U</p>  <p>L=24,3 mm x 16</p>	<p>W1</p>  <p>x 1</p>	<p>W6</p>  <p>x 2</p>	<p>XA</p>  <p>x 1</p>	<p>XG</p>  <p>x 2</p>	<p>ZR</p>  <p>Ø 15 x 16</p>

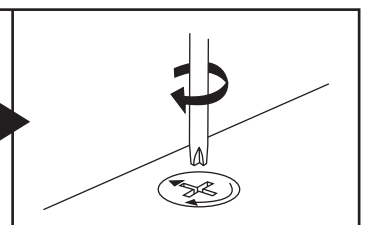
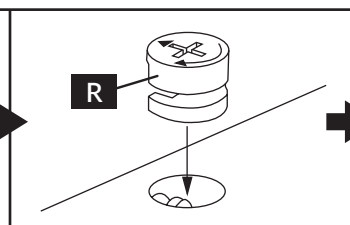
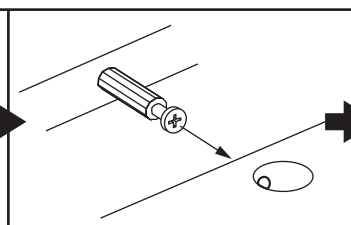
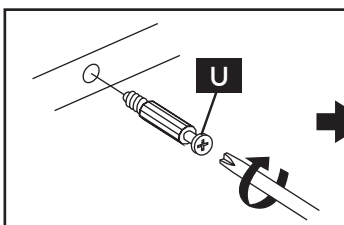
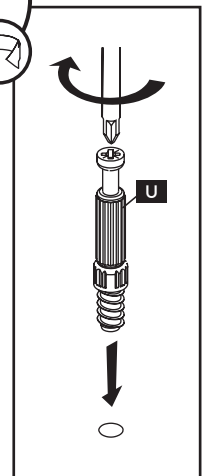
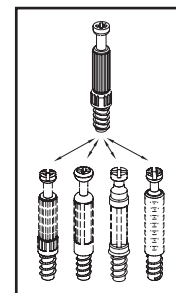
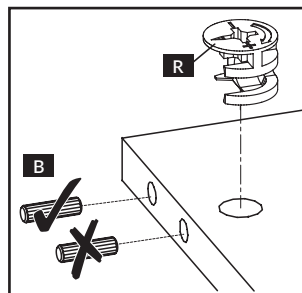
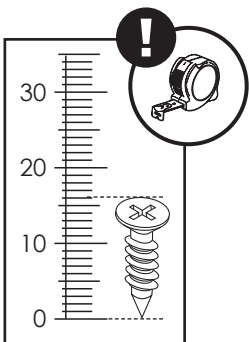
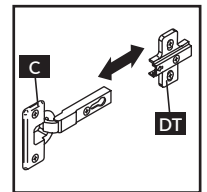
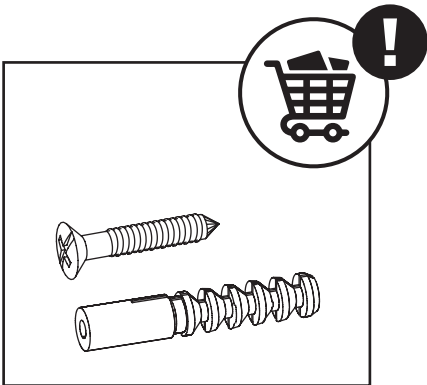



nr	↔ [mm]	↓ [mm]	∇ [mm]	Menge	Colli
B-1	520	80	16	x 1	1/1
B-2	288	80	16	x 2	1/1
B-3	601	384	16	x 1	1/1
B-4	568	343	16	x 2	1/1
B-5	567	330	4	x 2	1/1
B-6	601	384	16	x 1	1/1
B-7	1817	384	16	x 1	1/1
B-8	1817	384	16	x 1	1/1
B-9	100	1817	16	x 1	1/1
B-10	96	1849	16	x 1	1/1
B-11	446	250	16	x 1	1/1
B-12	446	448	16	x 1	1/1
B-13	96	1151	16	x 1	1/1
B-14	375	1200	4	x 1	1/1
B-15	580	1831	3	x 1	1/1

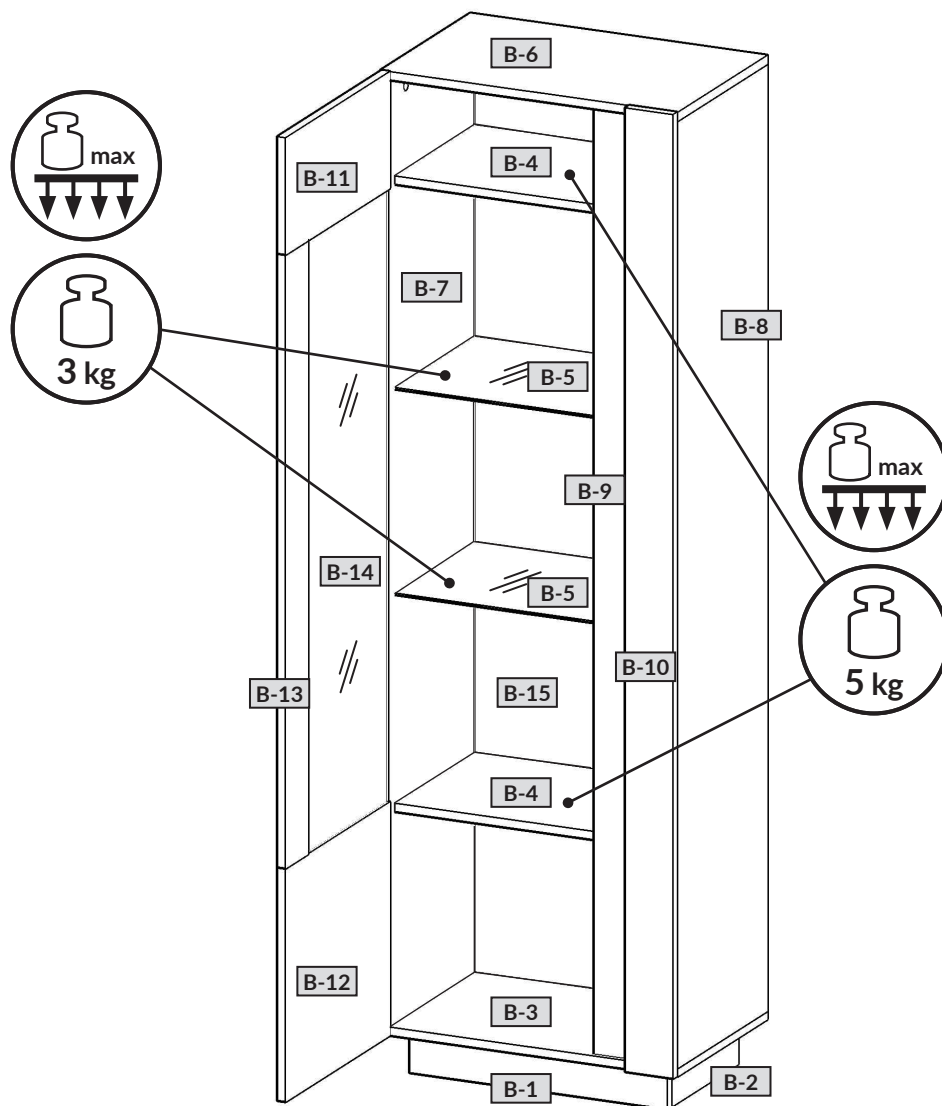



1

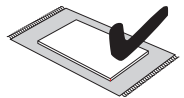
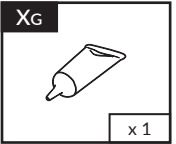
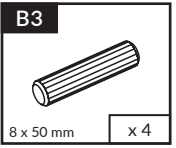
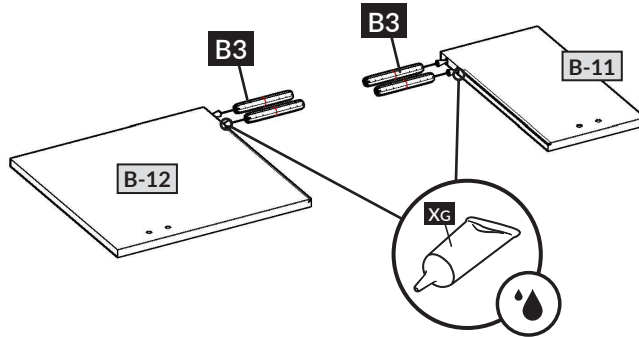

2

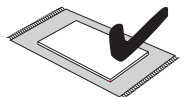
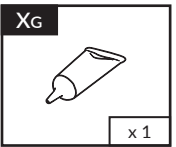
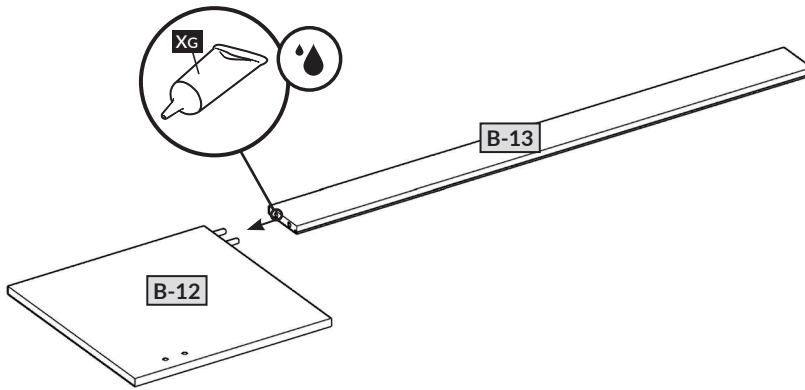

3

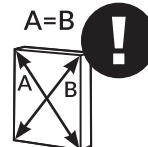
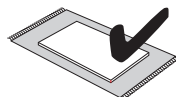
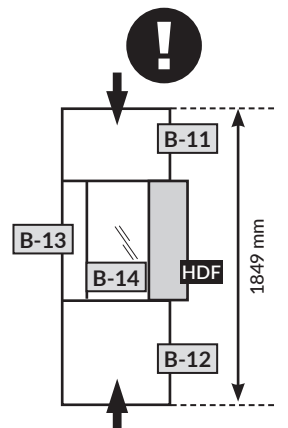
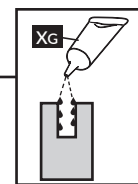
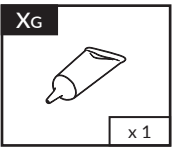
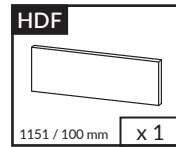
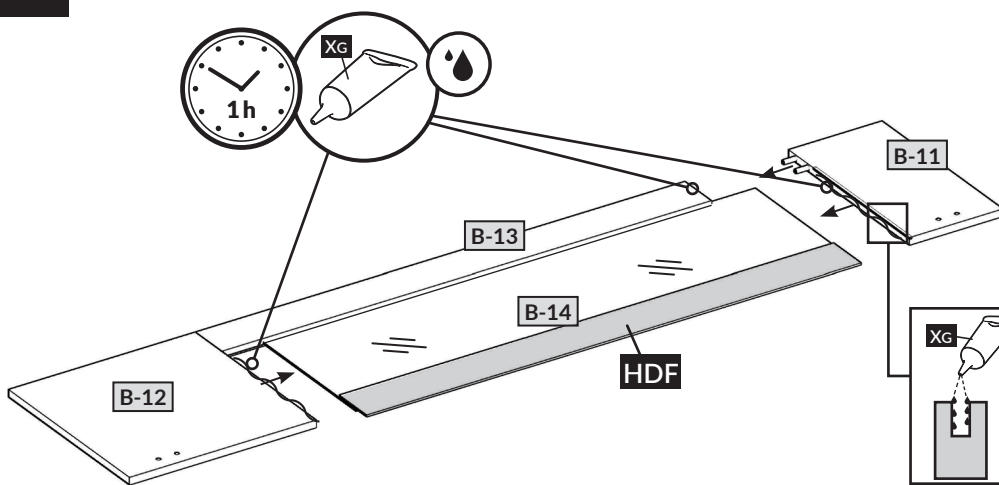



4

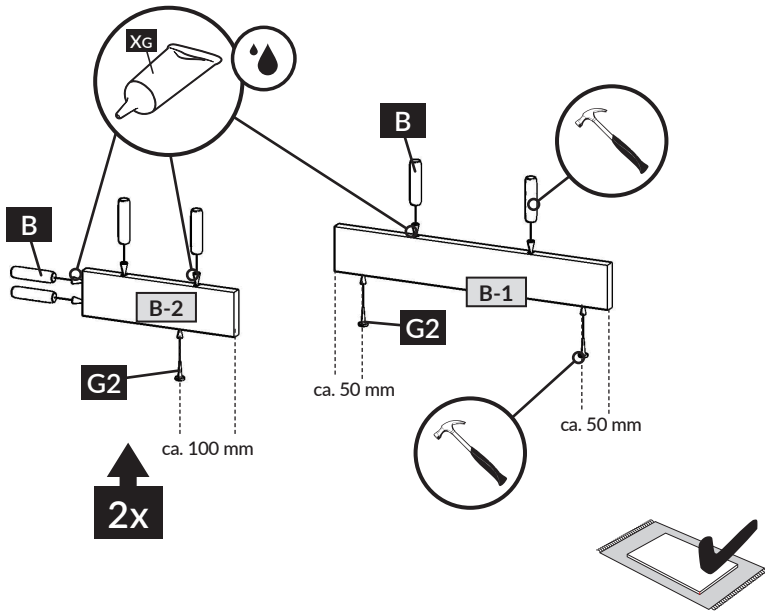
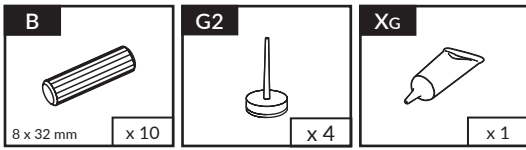

5

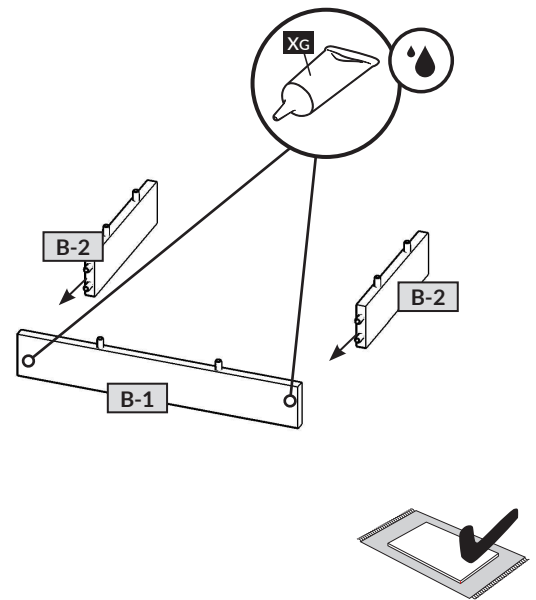
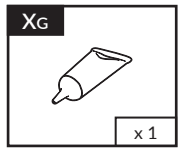

6

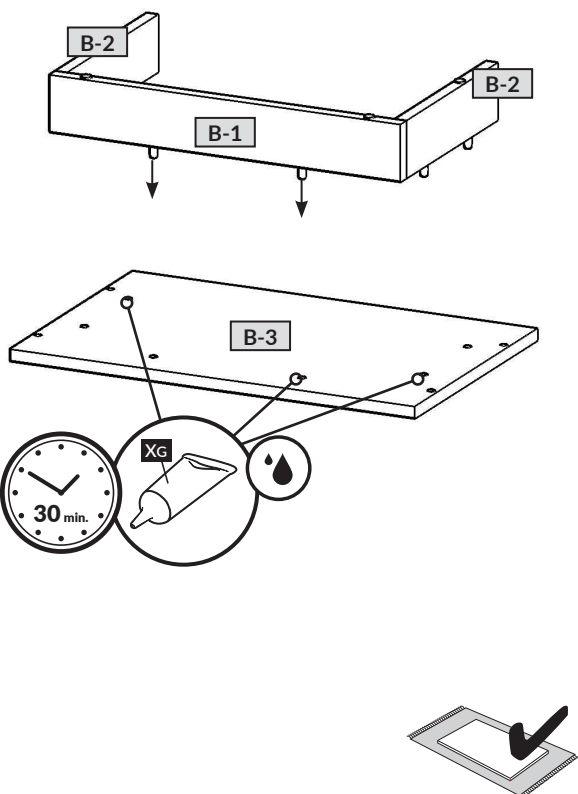
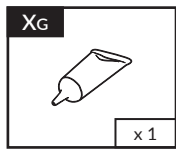

7

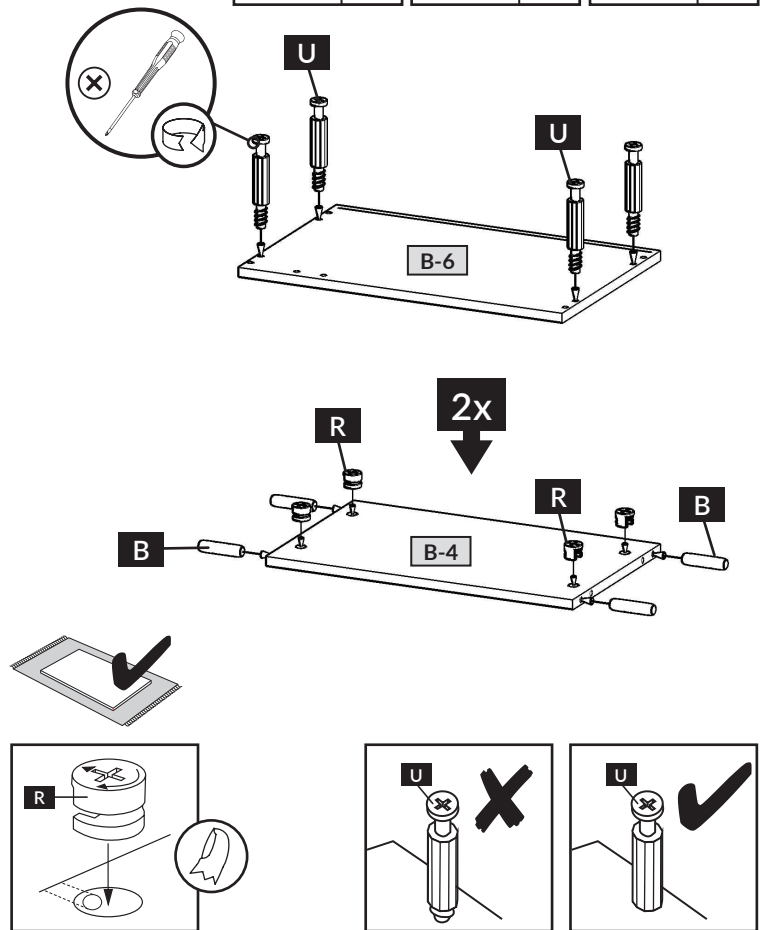
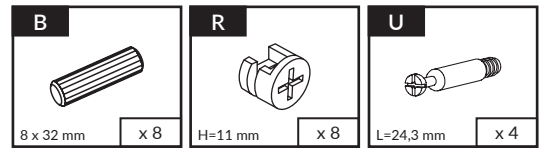



8

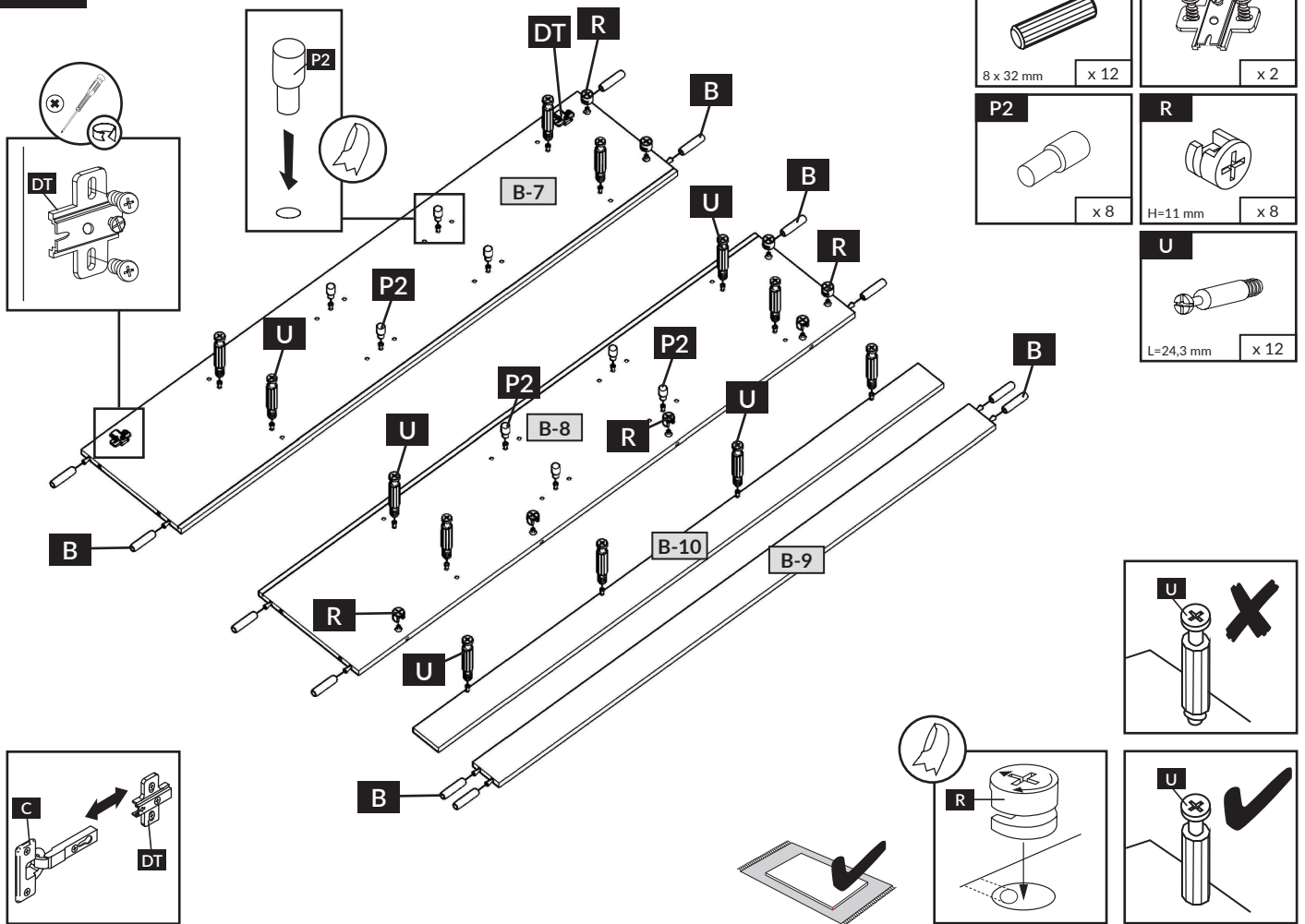

9

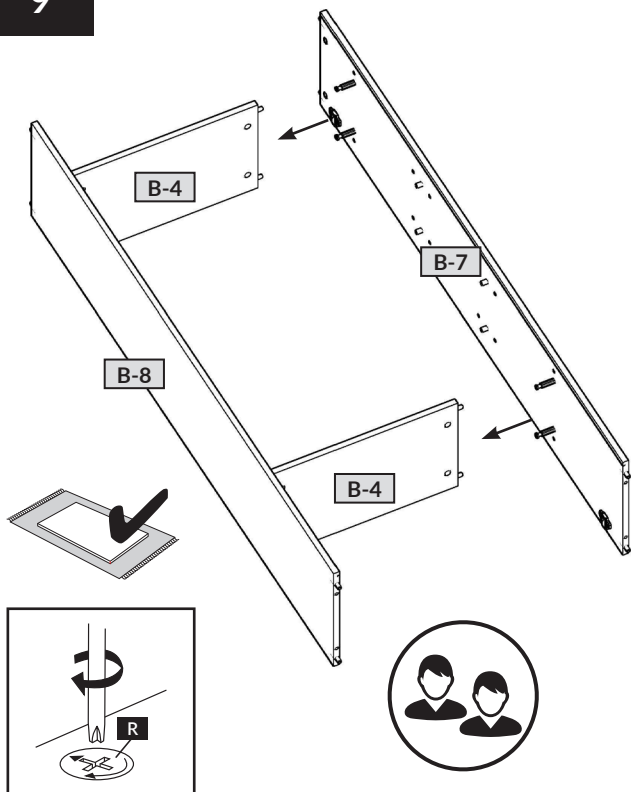

10

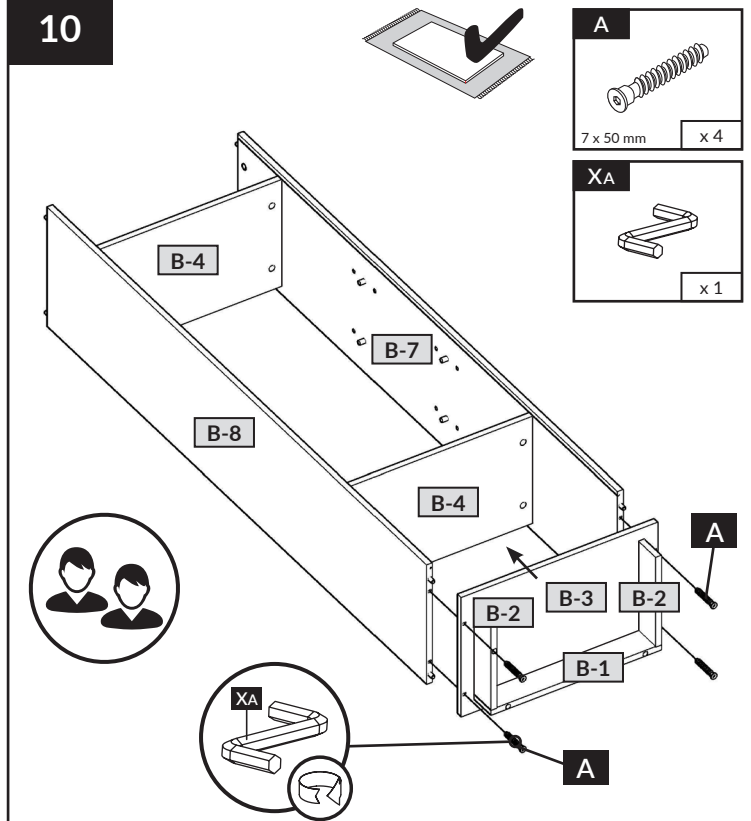



11

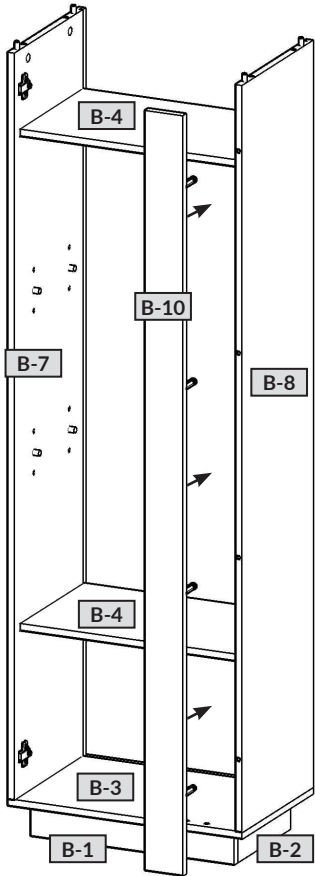
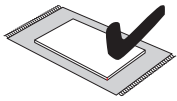

12

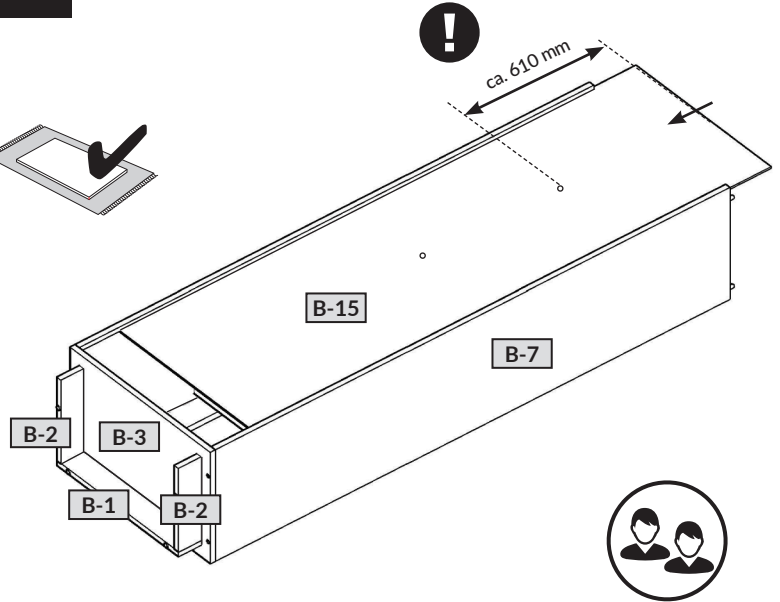
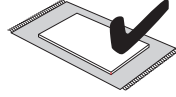

13

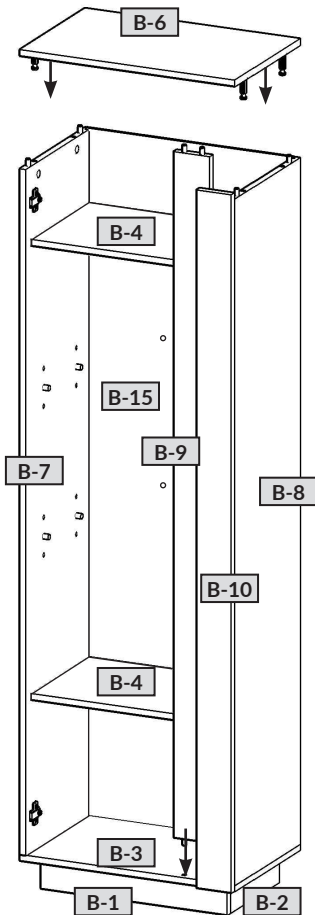
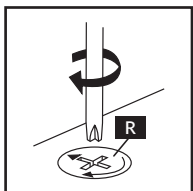
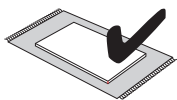

14

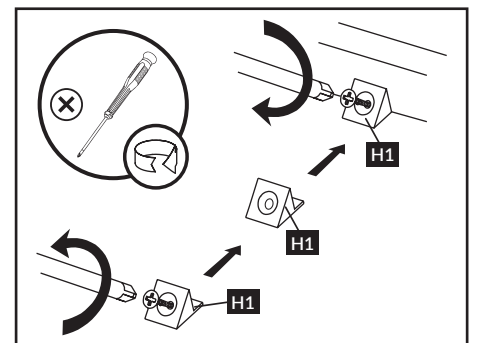
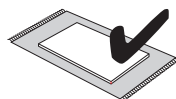
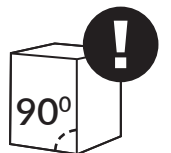
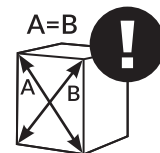
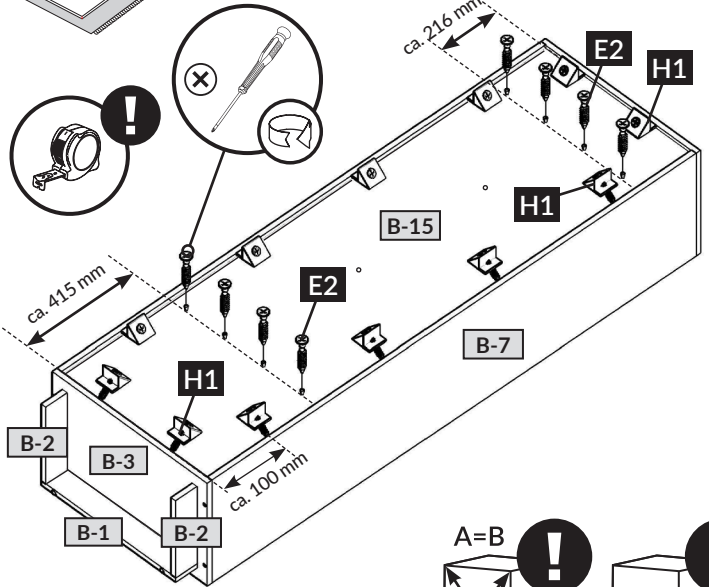
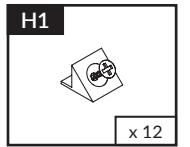
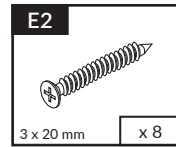
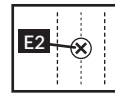
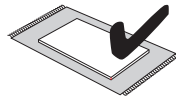



15

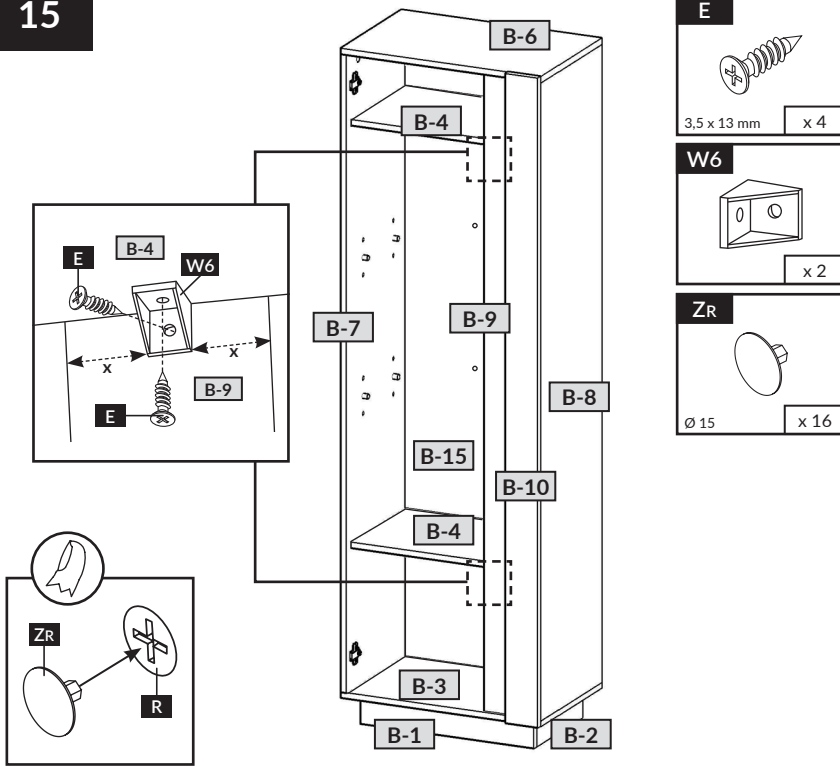



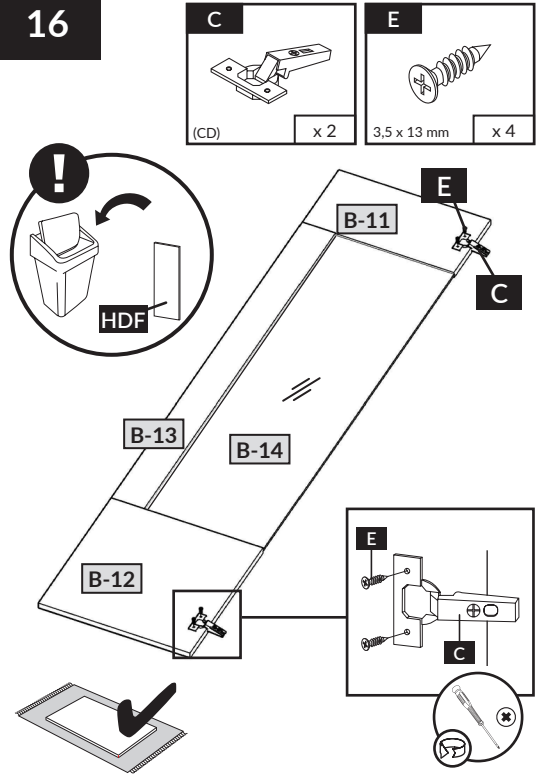



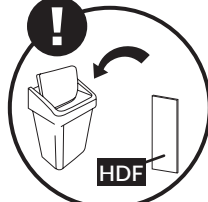
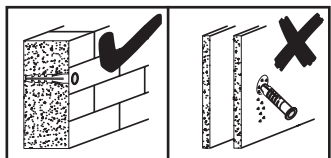
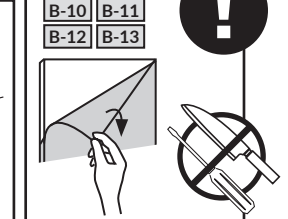
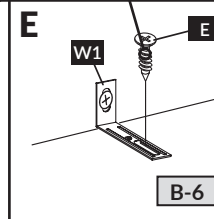
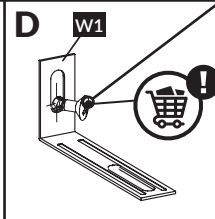
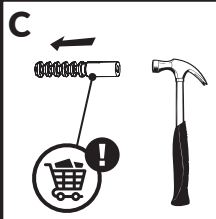
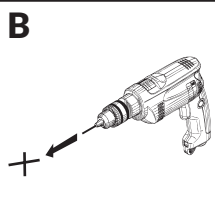
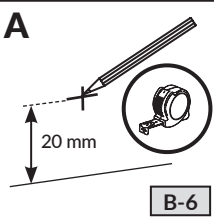
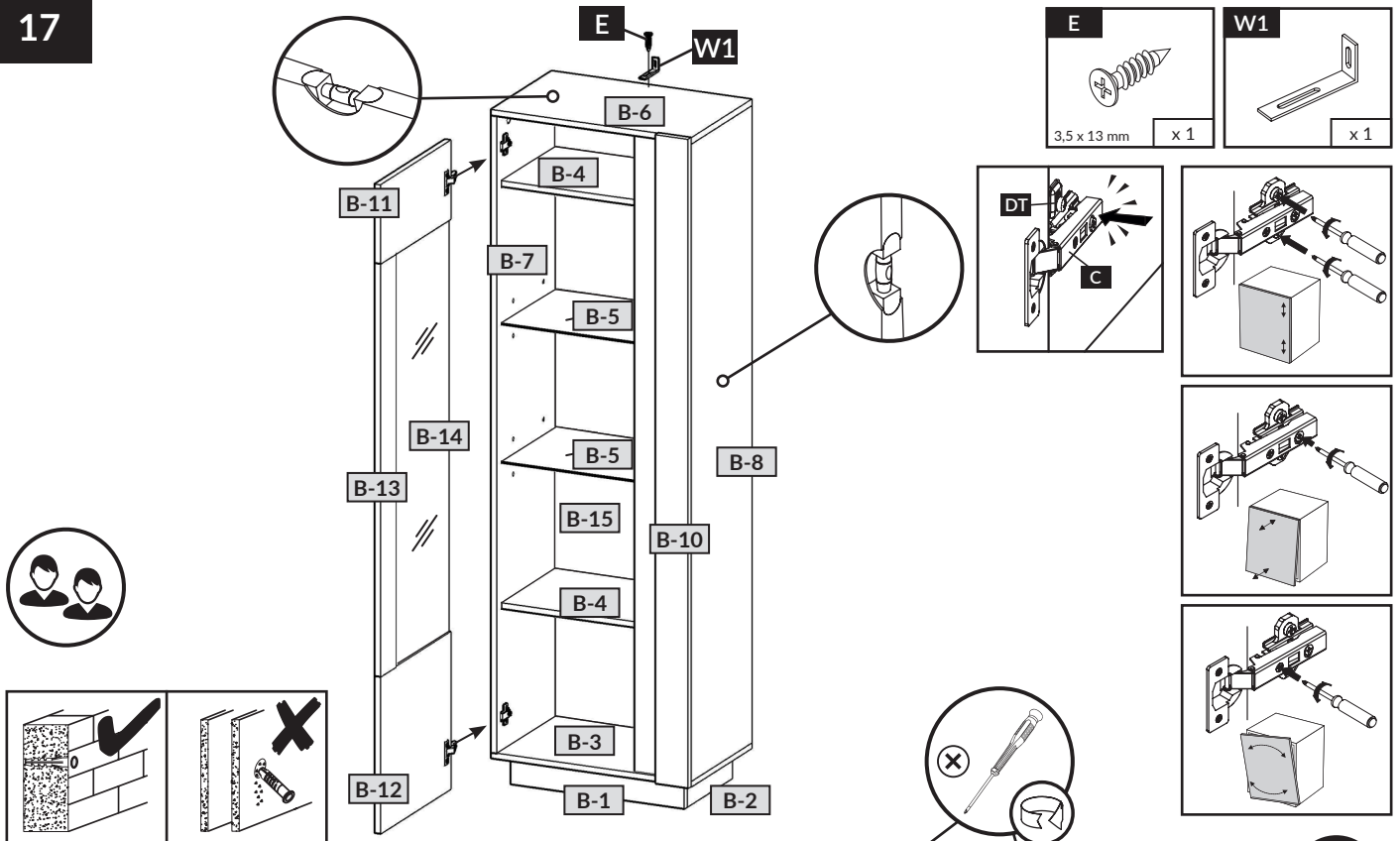

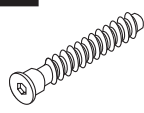
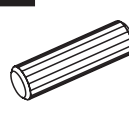
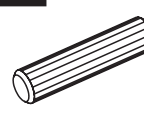

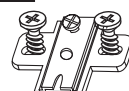
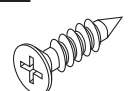
16

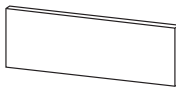
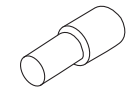

17

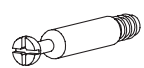
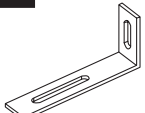
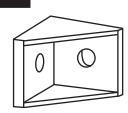
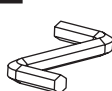

A  7 x 50 mm X ...	B  8 x 32 mm X ...	B3  8 x 50 mm X ...
C  (CD) X ...	DT  X ...	E  3,5 x 13 mm X ...
E2  3 x 20 mm X ...	G2  X ...	H1  X ...
HDF  1151 / 100 mm X ...	P2  X ...	R  H=11 mm X ...
U  L=24,3 mm X ...	W1  X ...	W6  X ...
XA  X ...	XG  X ...	ZR  Ø 15 X ...

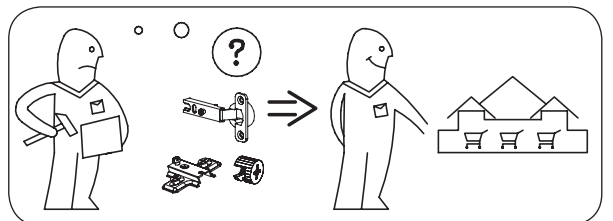
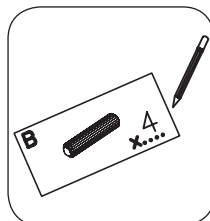

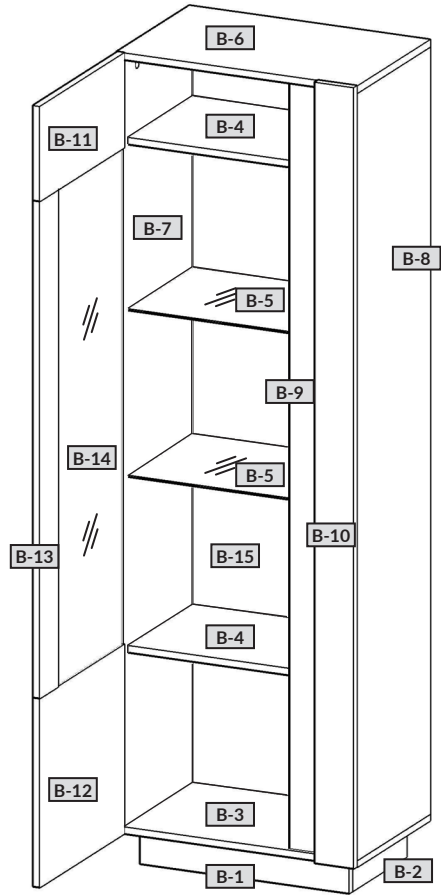

nr	↔ [mm]	↑ [mm]	∅ [mm]	Menge	Colli
B-1	520	80	16	x 1	1/1
B-2	288	80	16	x 2	1/1
B-3	601	384	16	x 1	1/1
B-4	568	343	16	x 2	1/1
B-5	567	330	4	x 2	1/1
B-6	601	384	16	x 1	1/1
B-7	1817	384	16	x 1	1/1
B-8	1817	384	16	x 1	1/1
B-9	100	1817	16	x 1	1/1
B-10	96	1849	16	x 1	1/1
B-11	446	250	16	x 1	1/1
B-12	446	448	16	x 1	1/1
B-13	96	1151	16	x 1	1/1
B-14	375	1200	4	x 1	1/1
B-15	580	1831	3	x 1	1/1

