

2023-05-09

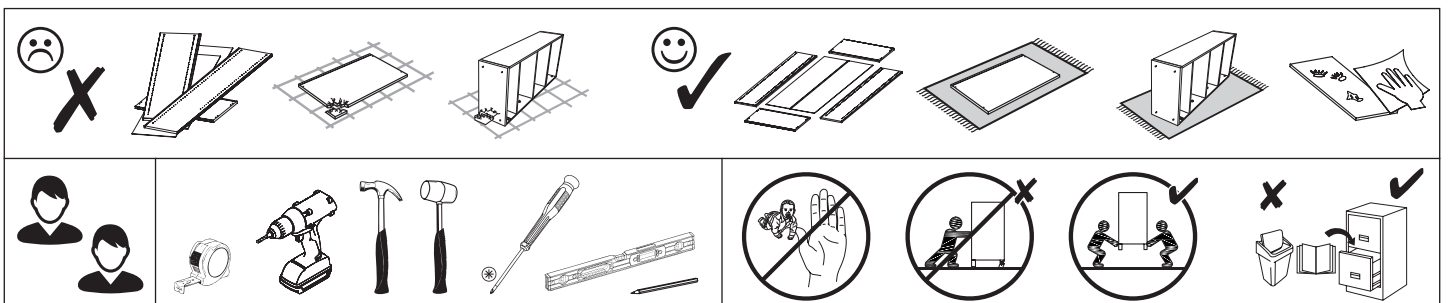

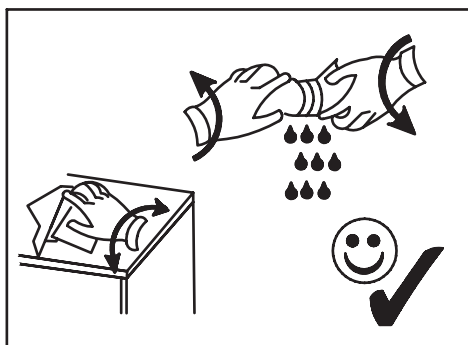

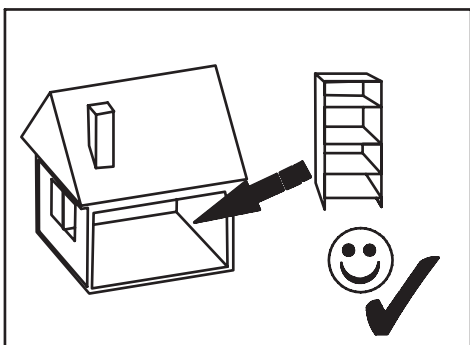
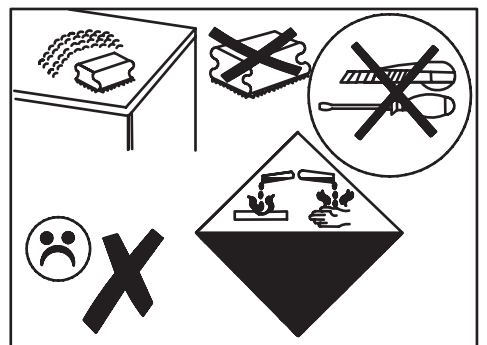
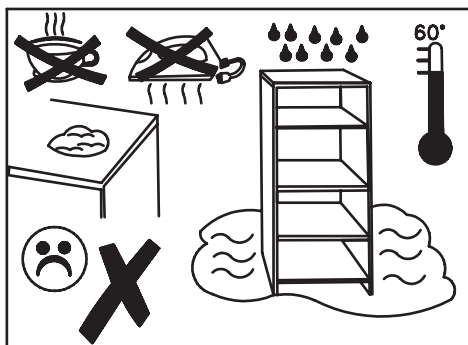
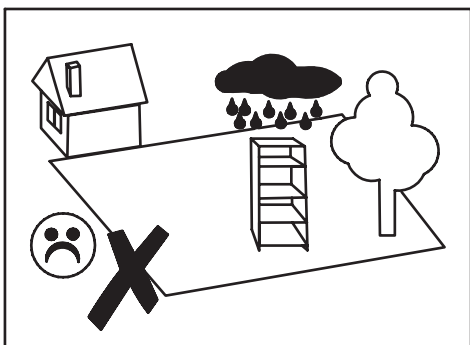
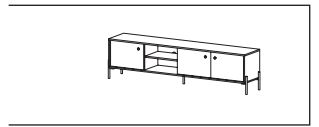
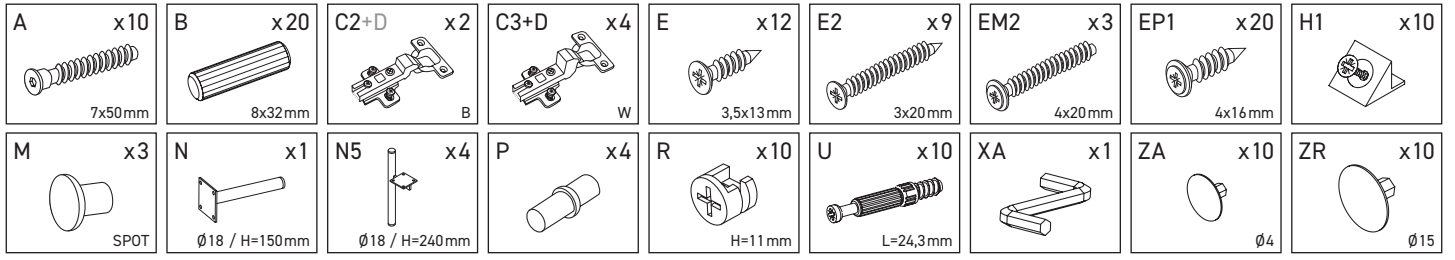
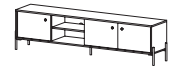

E-1	2029	395	16	x1	1/2
E-2	2029	395	16	x1	1/2
E-3	352	394	16	x1	1/2
E-4	352	394	16	x1	1/2
E-5	352	345	16	x1	1/2
E-6	352	345	16	x1	1/2
E-7	352	345	16	x1	1/2
E-8	482	335	16	x1	1/2
E-9	346	496	16	x2	1/2
E-10	346	496	16	x1	1/2
E-11	2010	366	3	x1	1/2

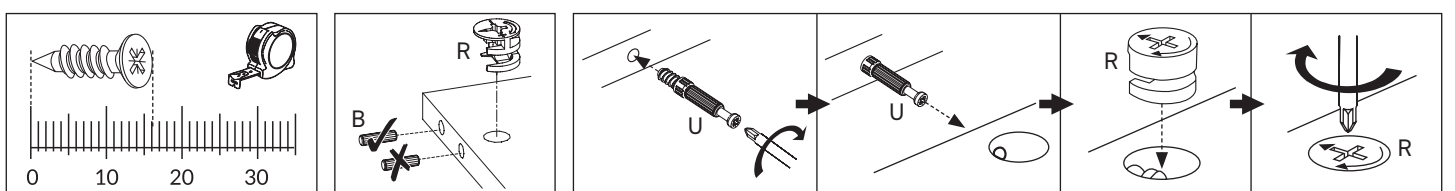
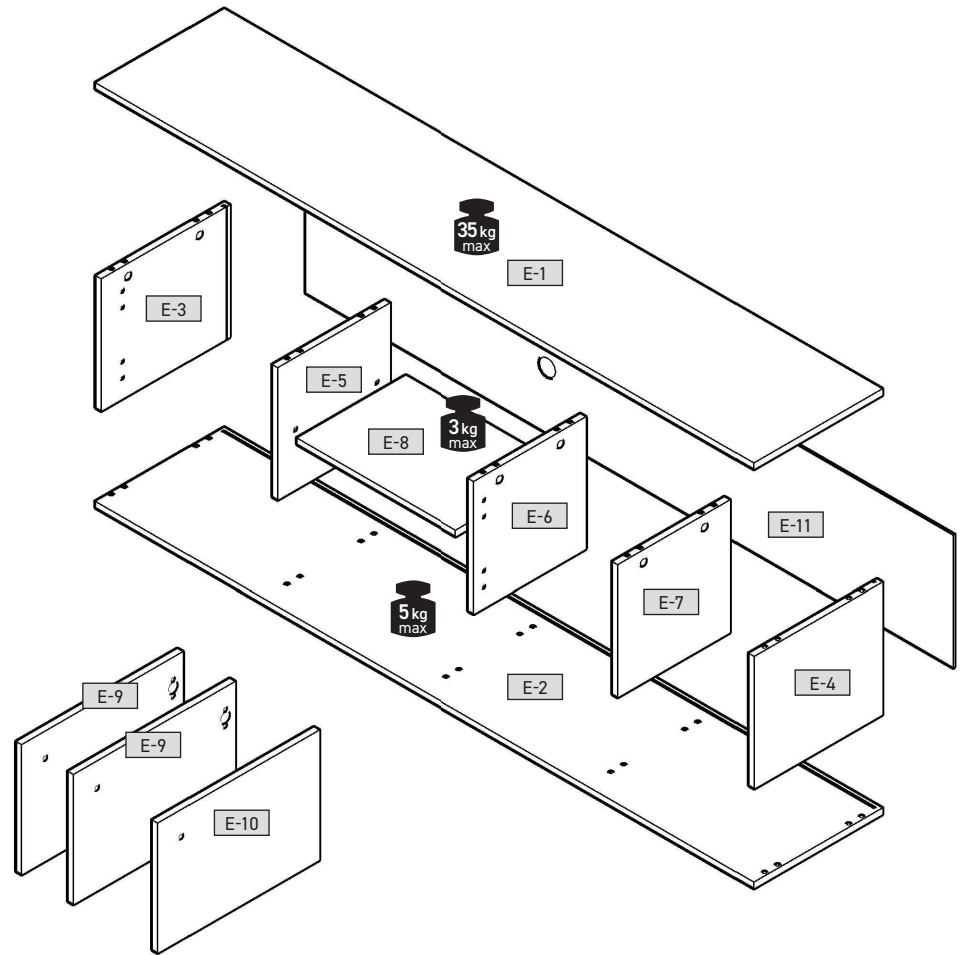
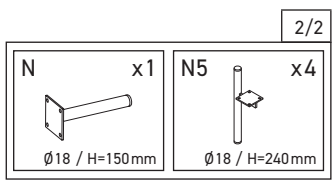

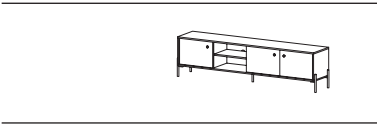

1

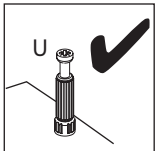
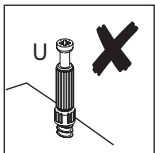
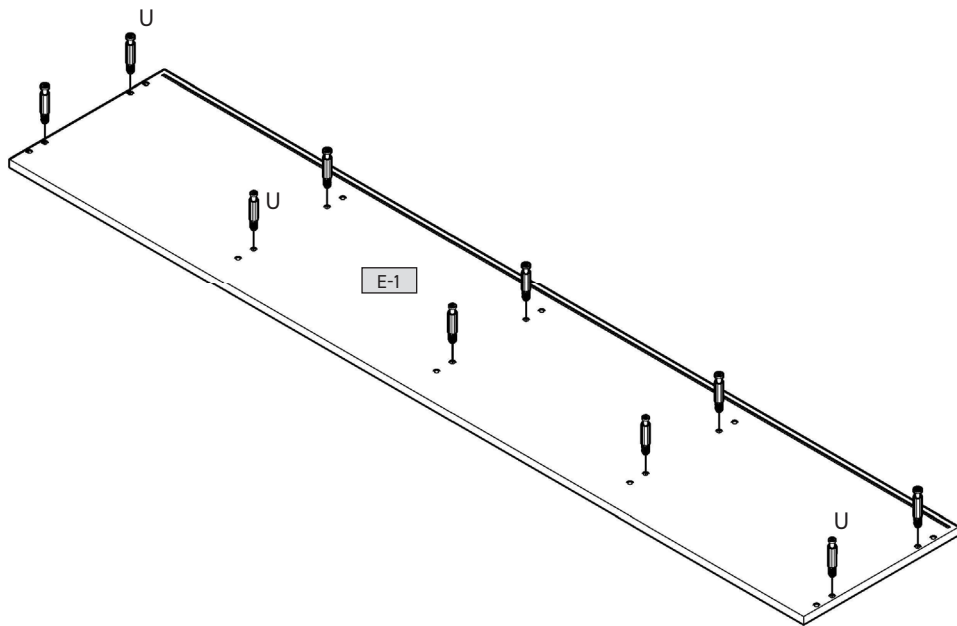
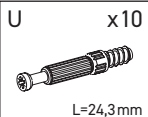

2

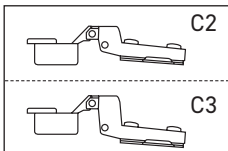
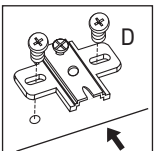
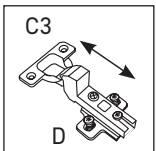
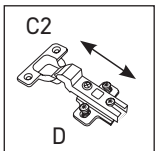
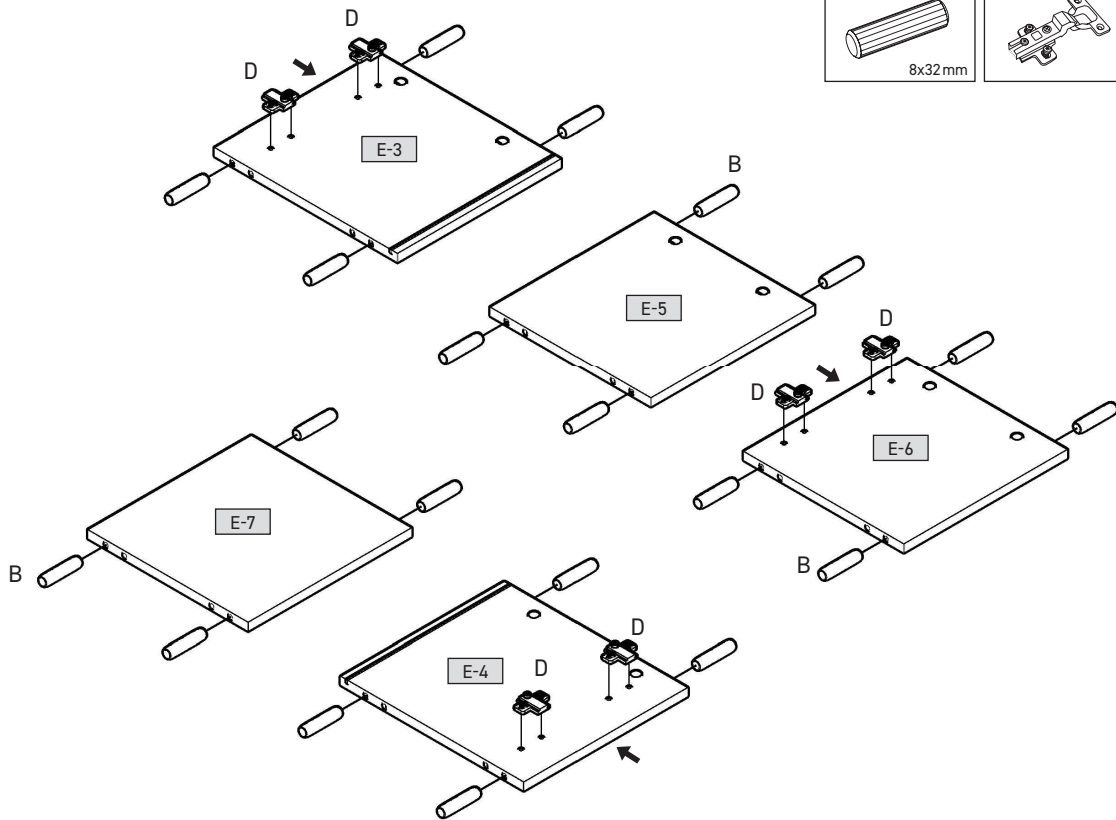
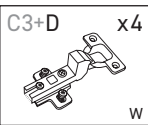
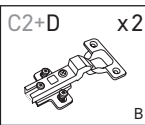
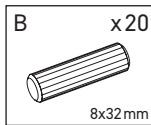

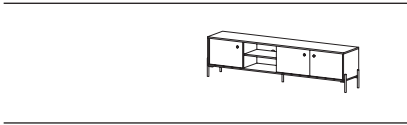

3

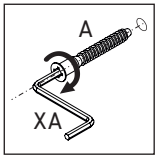
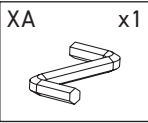
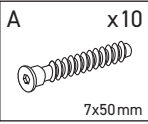
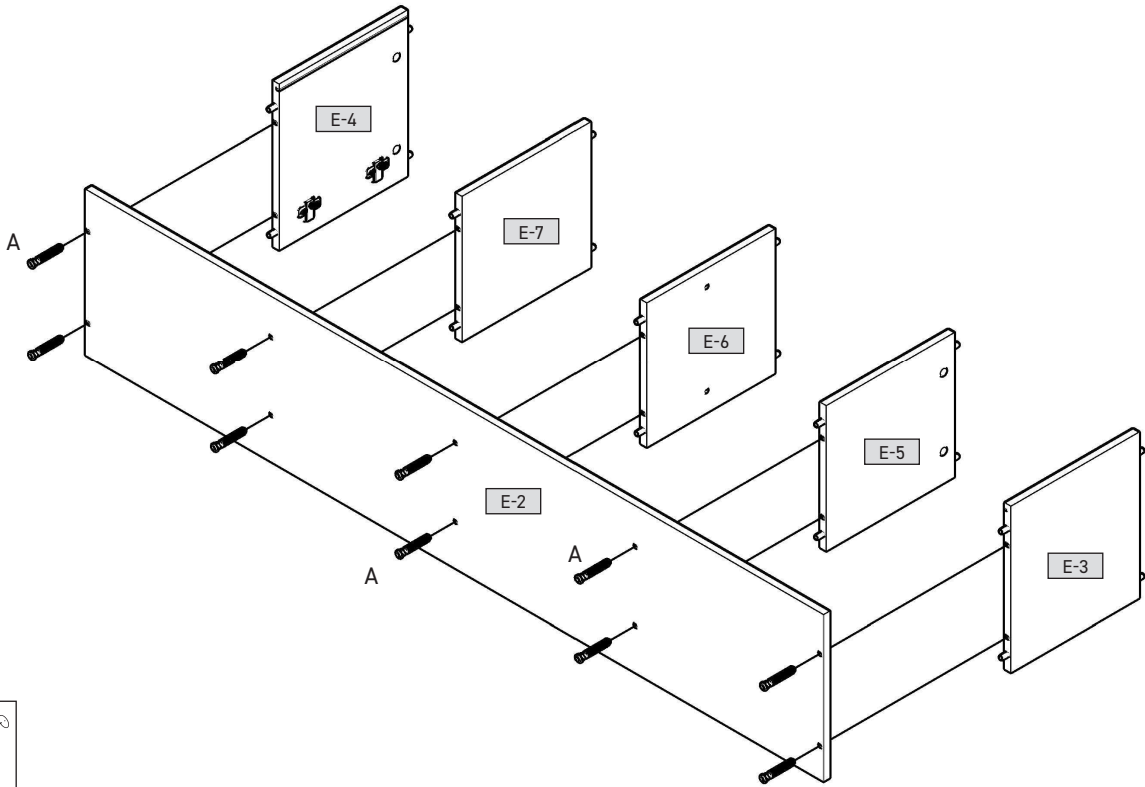

4

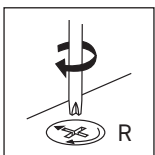
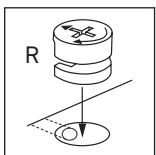
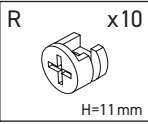
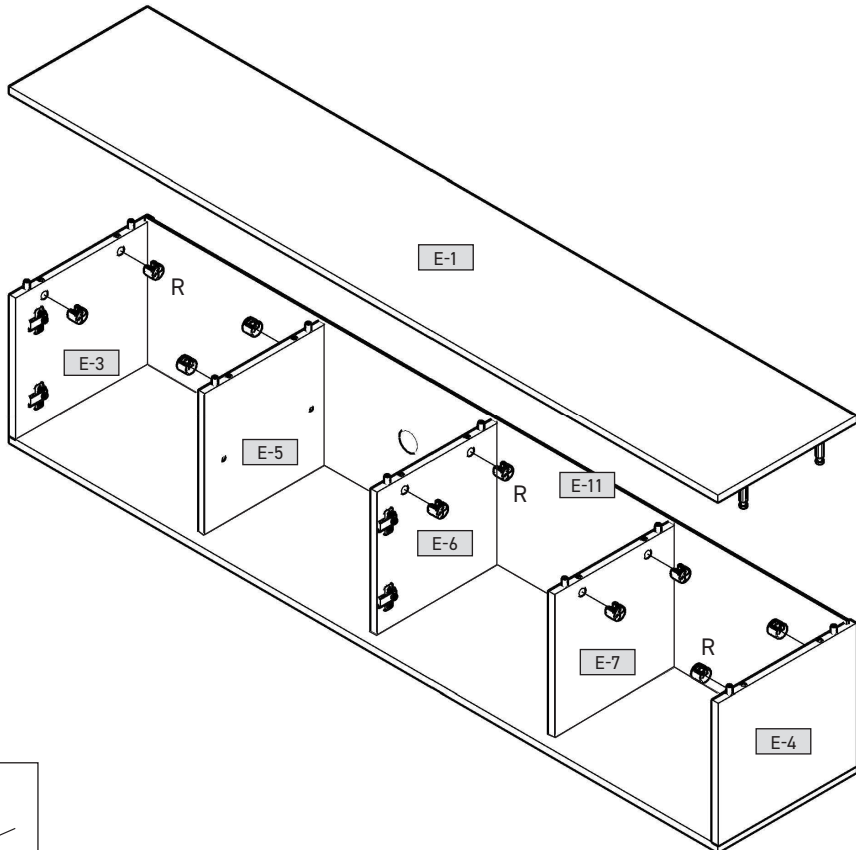

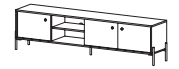

5

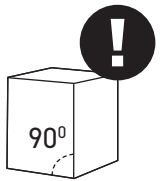
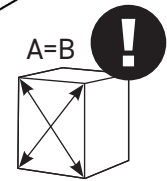
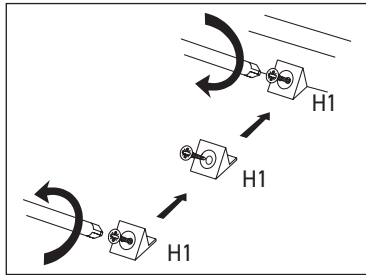
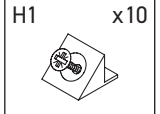
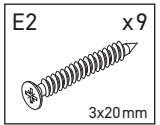
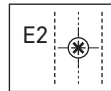
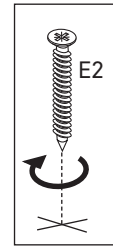
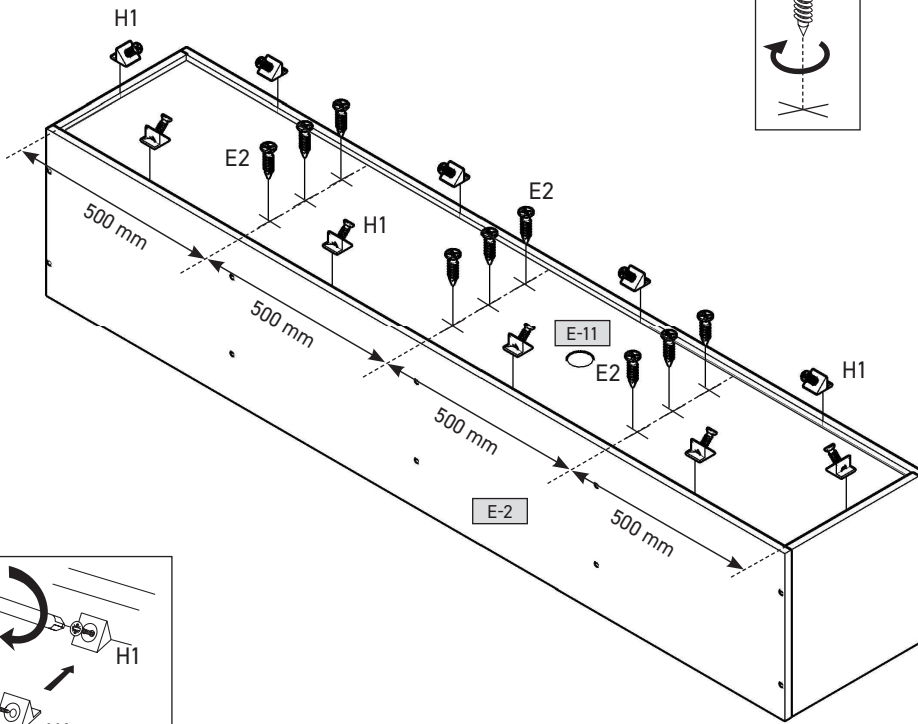
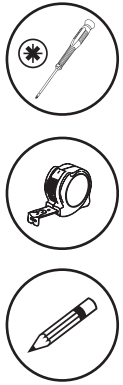

6

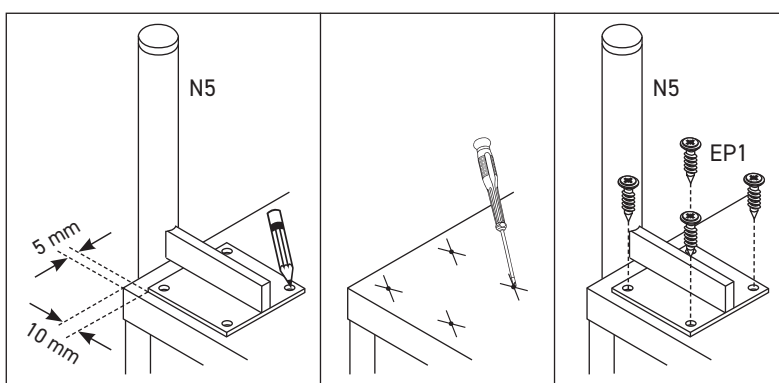
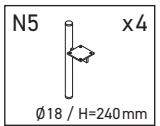
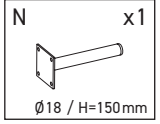
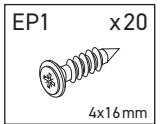
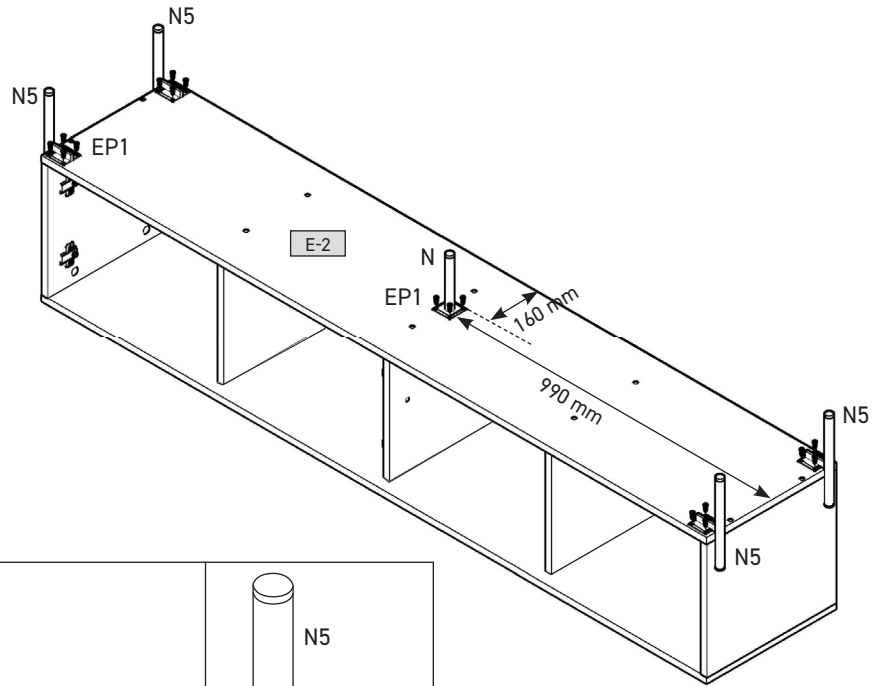
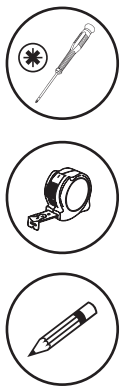

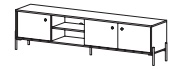

7

P x4

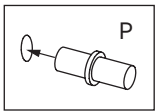
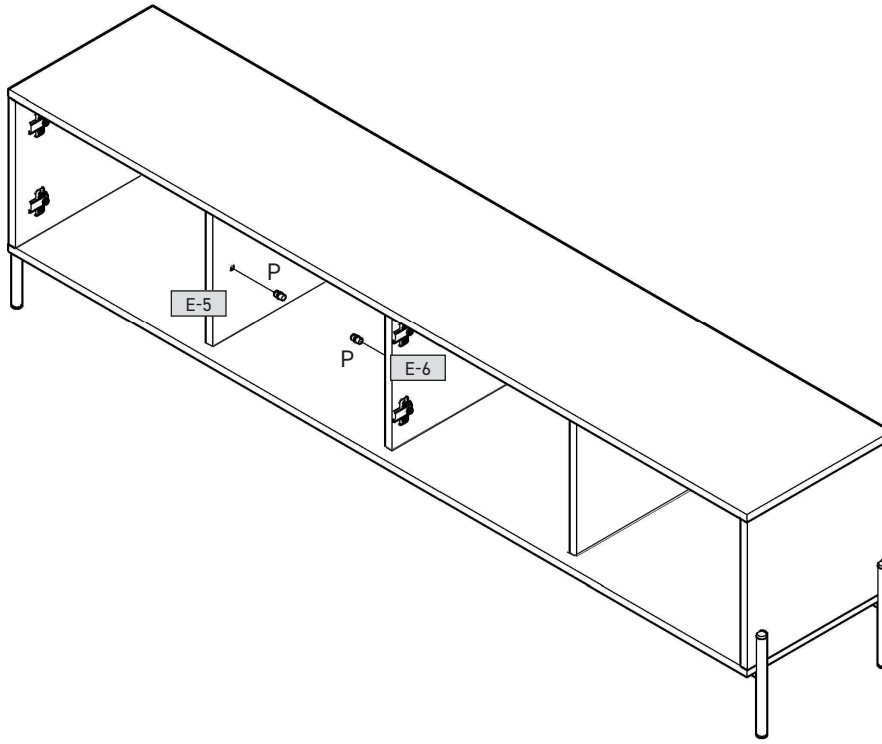
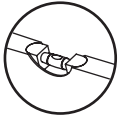

8



C2+D x2

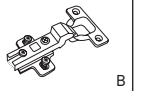

B

C3+D x4



W

E x12



3,5x13mm

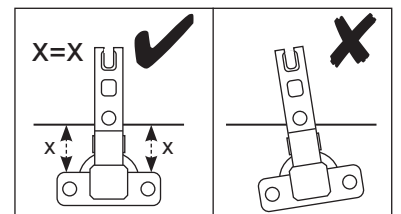
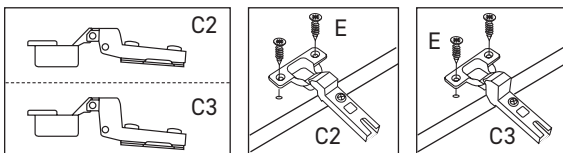
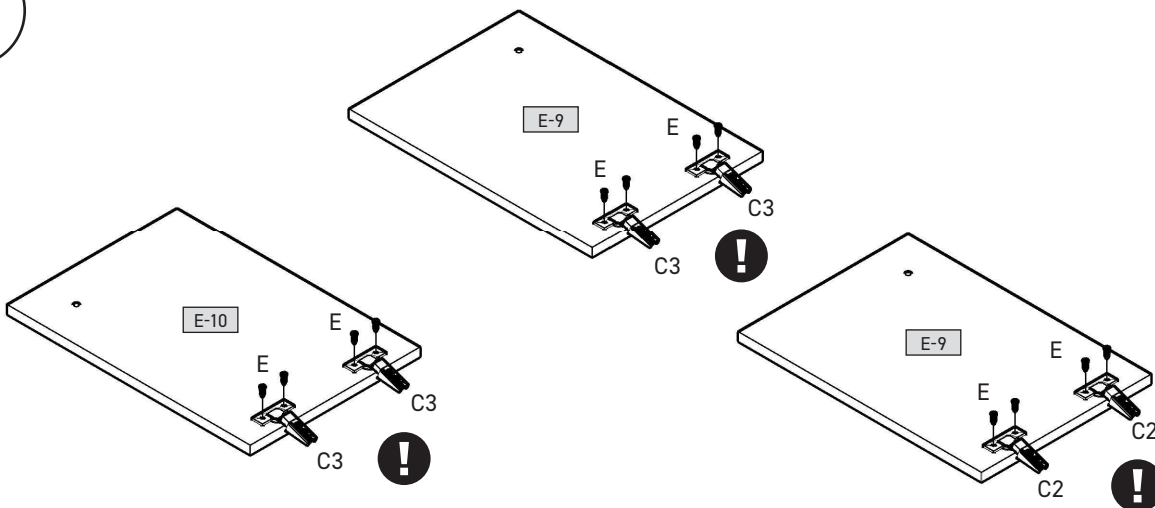

9

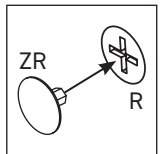
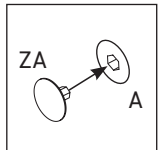
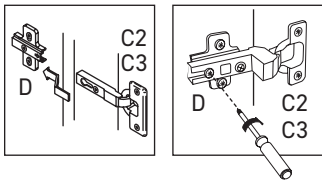
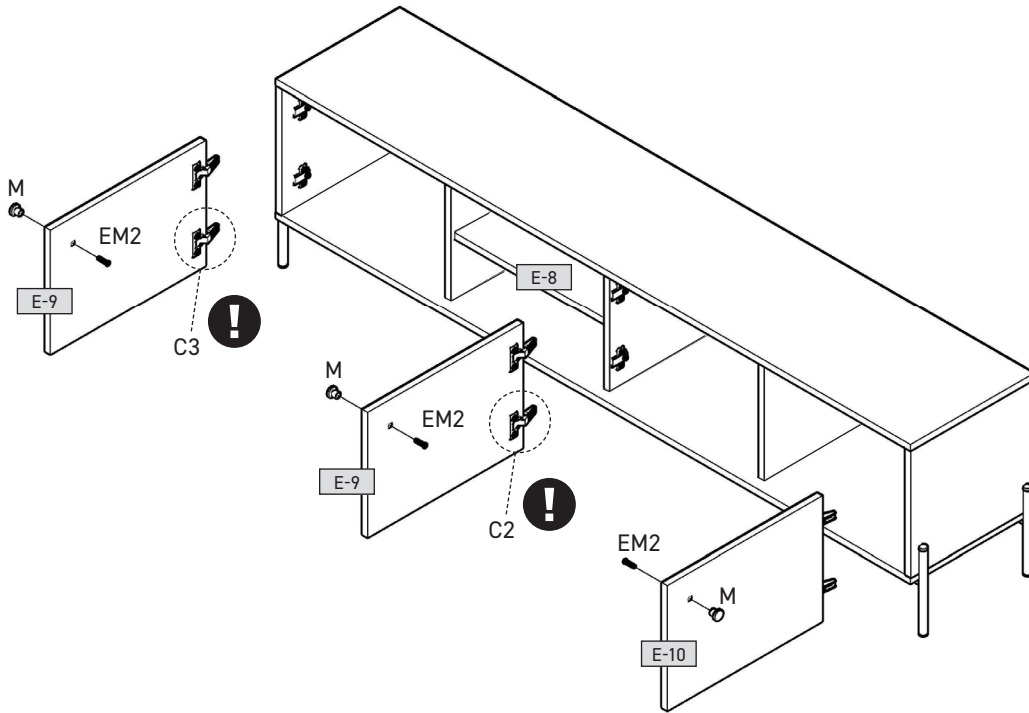
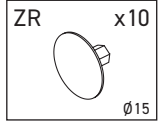
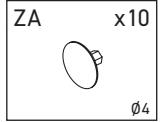
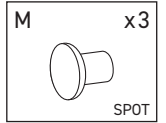
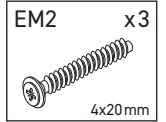
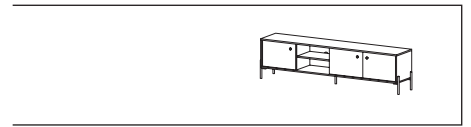

10

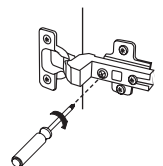
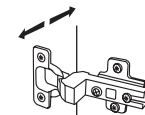
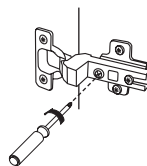
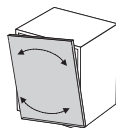
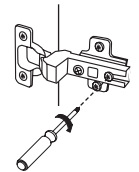
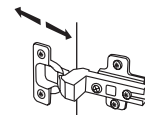
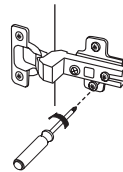
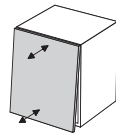
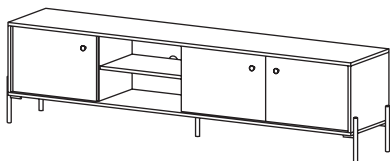
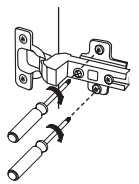
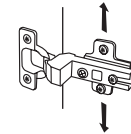
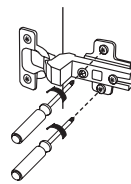
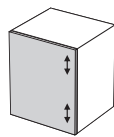

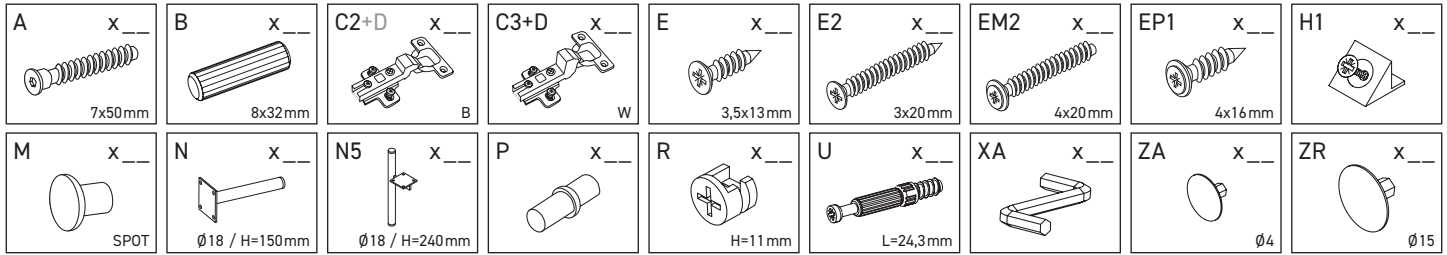

E-1	2029	395	16	x1	1/2
E-2	2029	395	16	x1	1/2
E-3	352	394	16	x1	1/2
E-4	352	394	16	x1	1/2
E-5	352	345	16	x1	1/2
E-6	352	345	16	x1	1/2
E-7	352	345	16	x1	1/2
E-8	482	335	16	x1	1/2
E-9	346	496	16	x2	1/2
E-10	346	496	16	x1	1/2
E-11	2010	366	3	x1	1/2

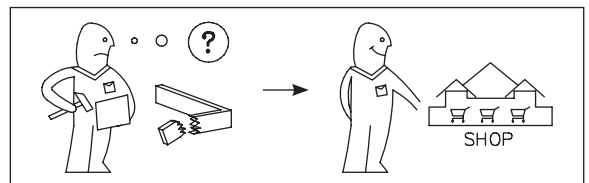
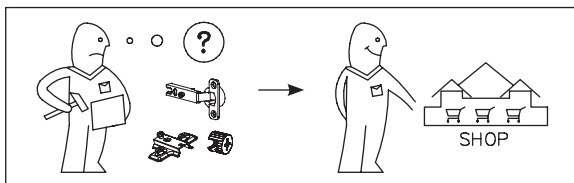
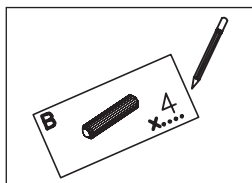
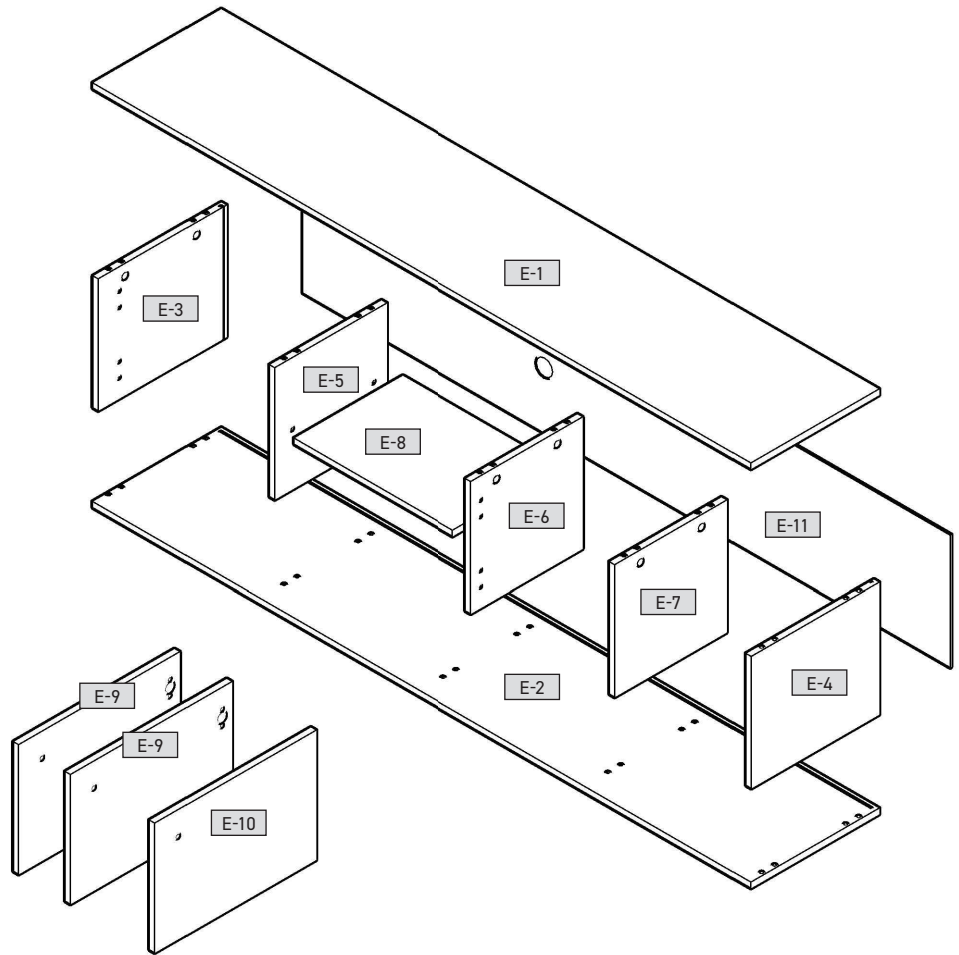
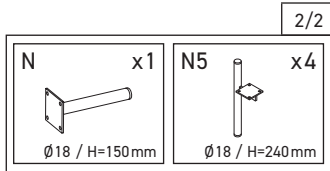

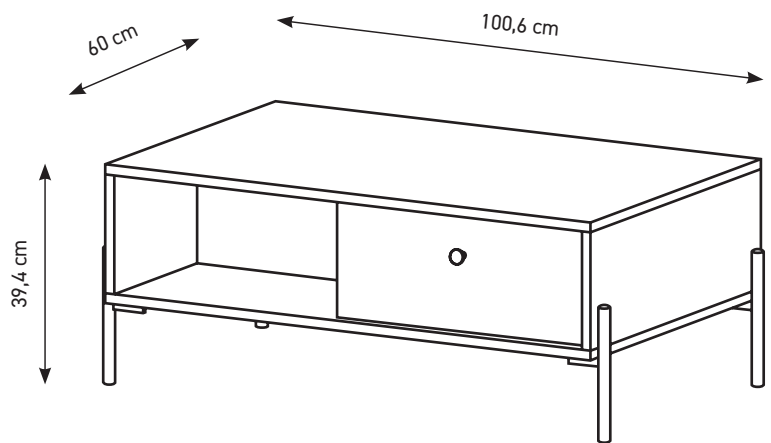

2023-10-09

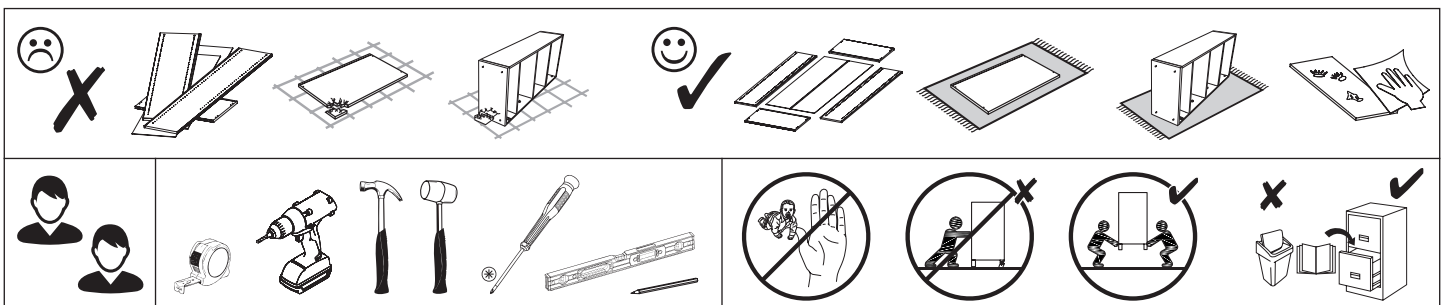

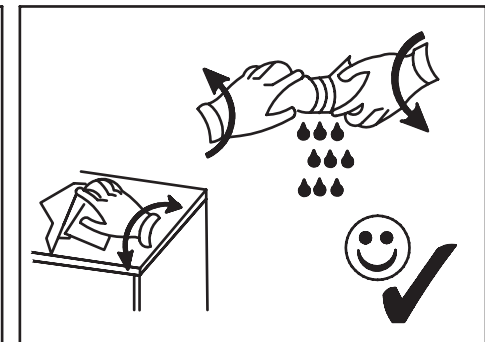
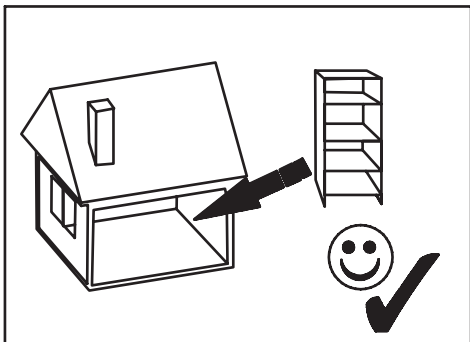
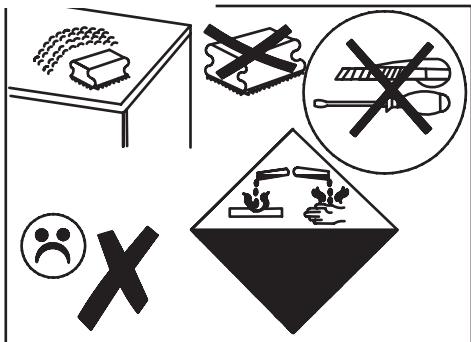
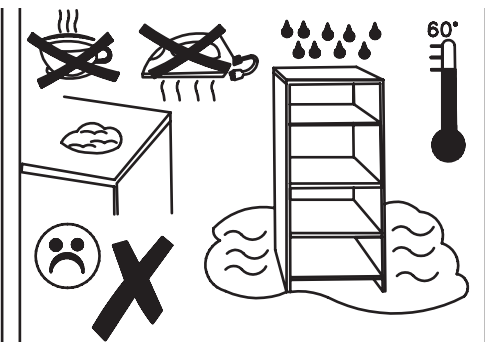
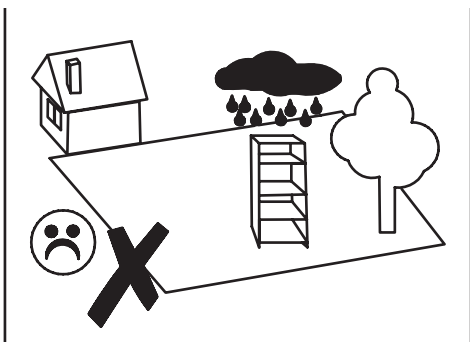
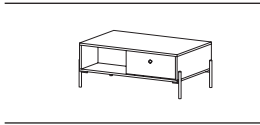

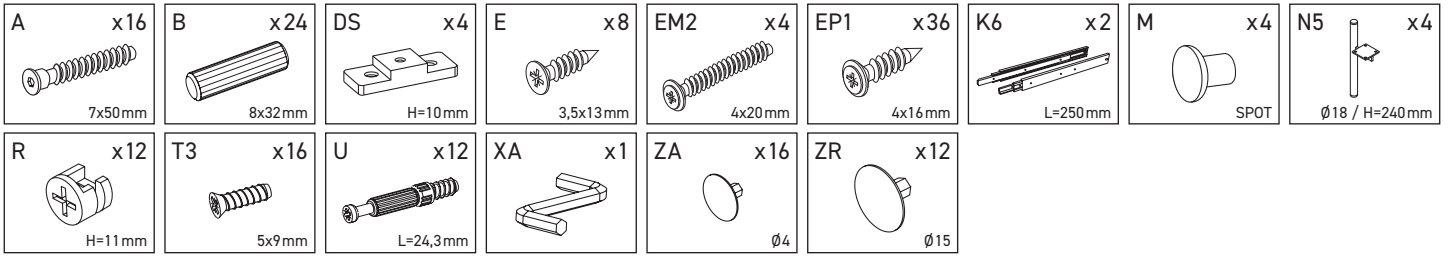

G-1	969	600	16	x1	1/2
G-2	969	600	16	x1	1/2
G-3	212	598	16	x1	1/2
G-4	212	598	16	x1	1/2
G-5	212	530	16	x1	1/2
G-6	212	320	16	x1	1/2
G-7	206	496	16	x2	1/2
G-8	260	120	16	x2	1/2
G-9	260	120	16	x2	1/2
G-10	426	120	16	x2	1/2
G-11	456	266	3	x2	1/2

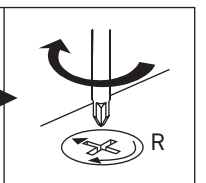
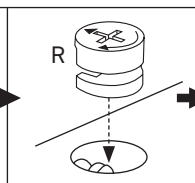
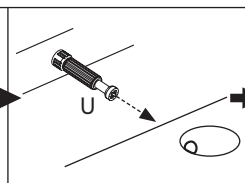
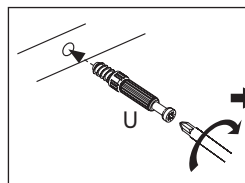
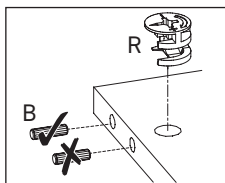
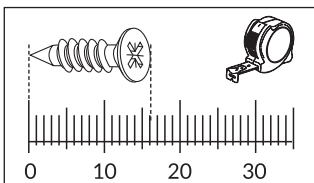
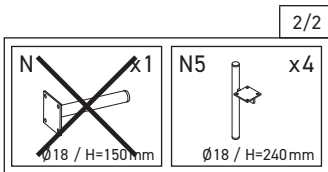
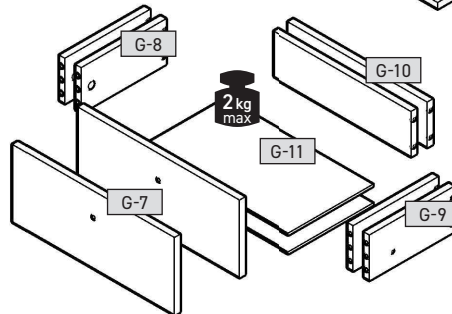
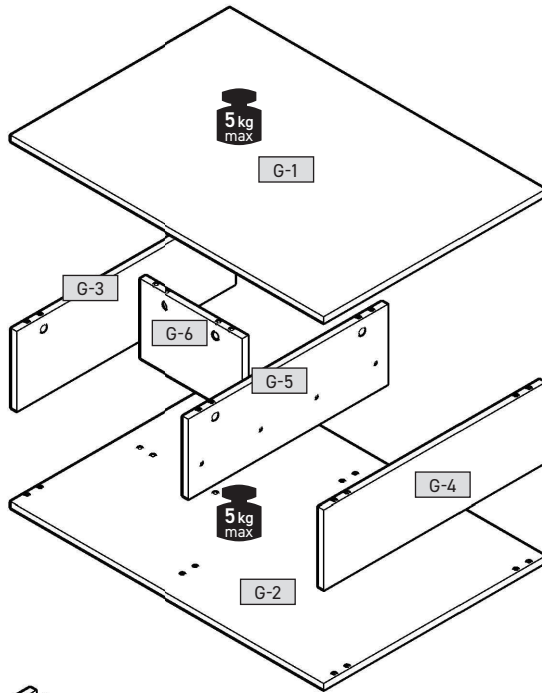



1



B x16 8x32mm	DS x4 H=10mm	E x8 3,5x13mm	U x8 L=24,3mm
---------------------------	---------------------------	----------------------------	----------------------------

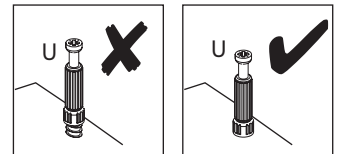
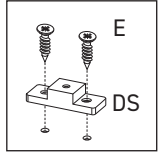
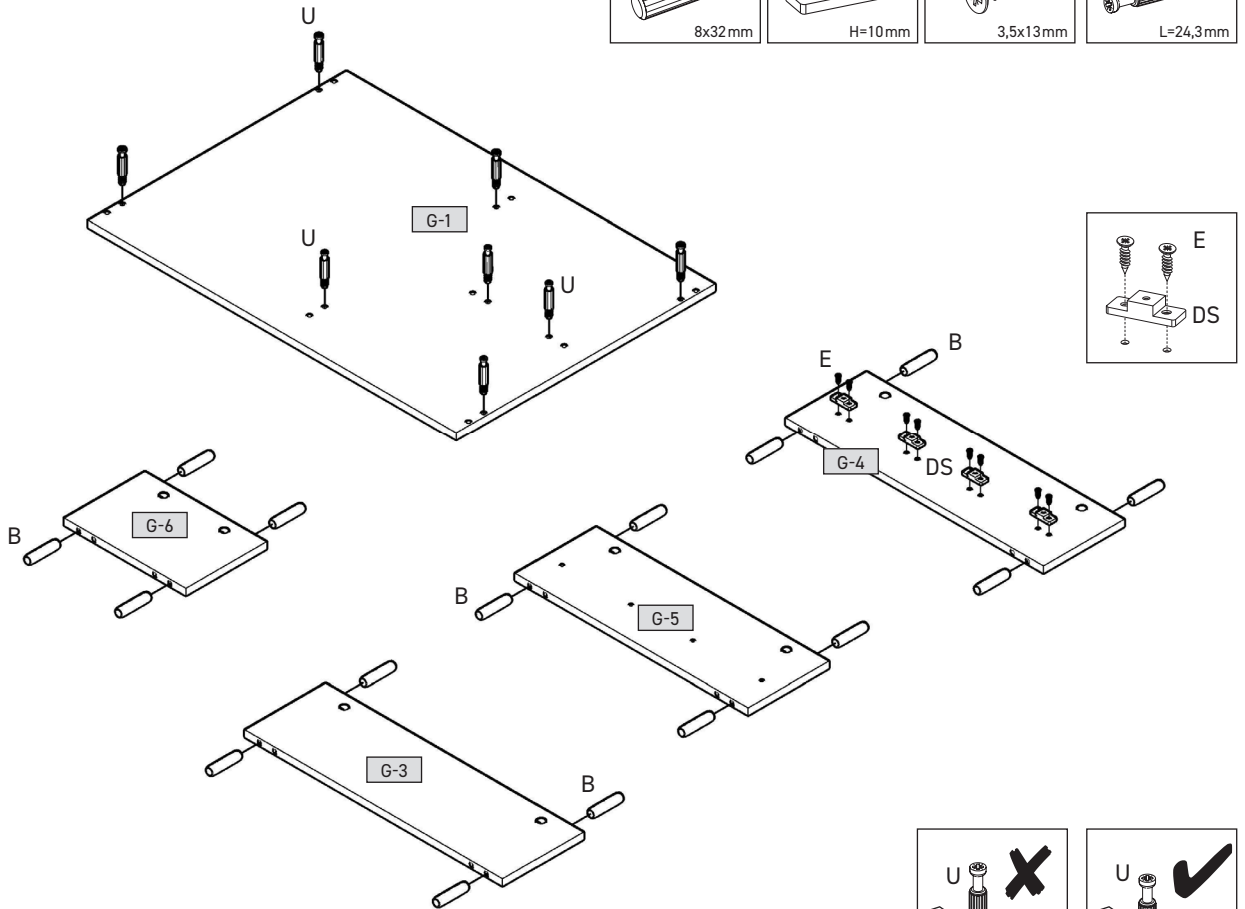

2



K6 x2 L=250mm	T3 x8 5x9mm
----------------------------	--------------------------

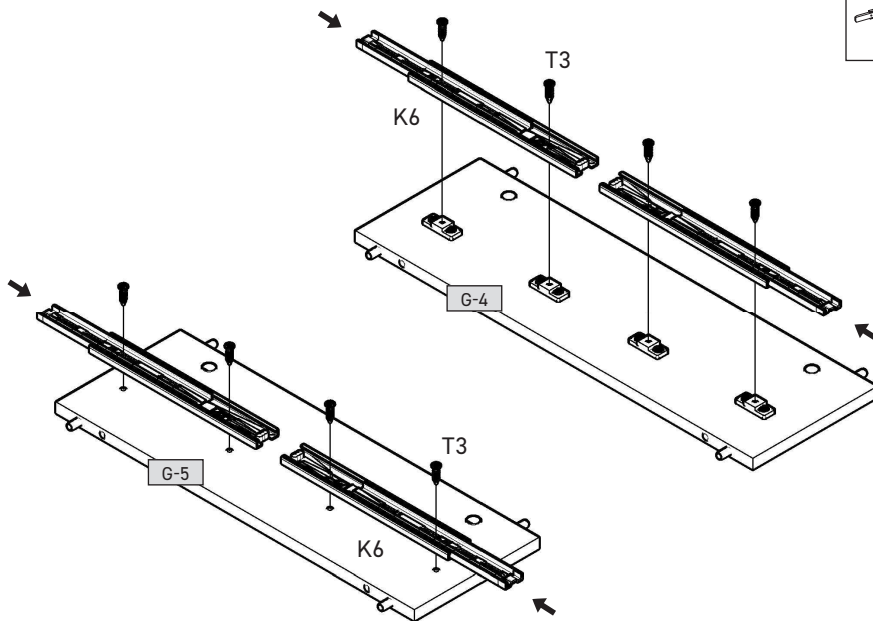

K6 = 2x (K6a+K6b)

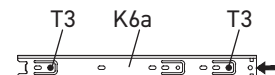

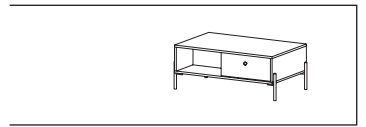

3

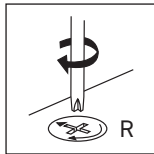
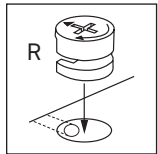
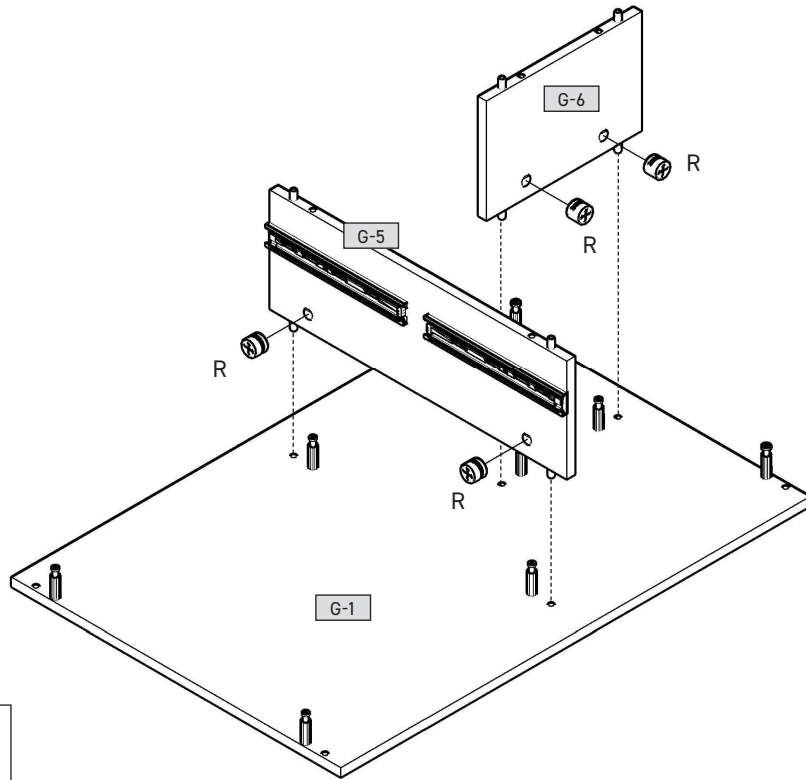
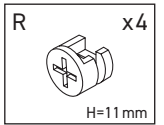

4

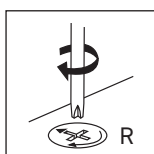
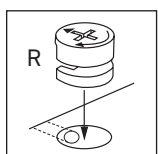
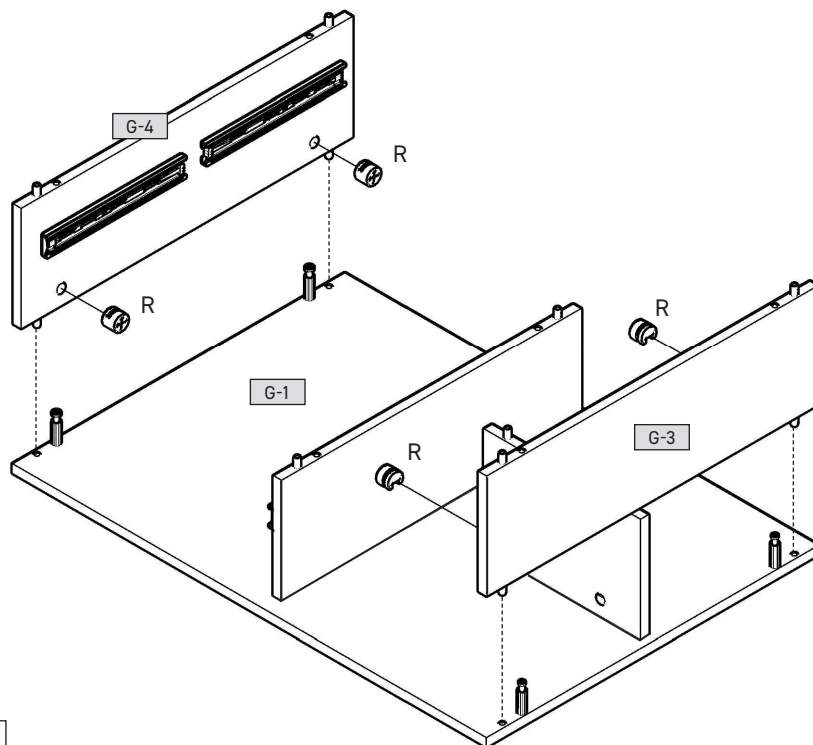
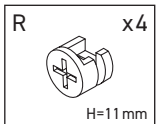



5

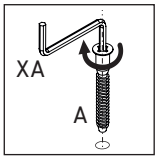
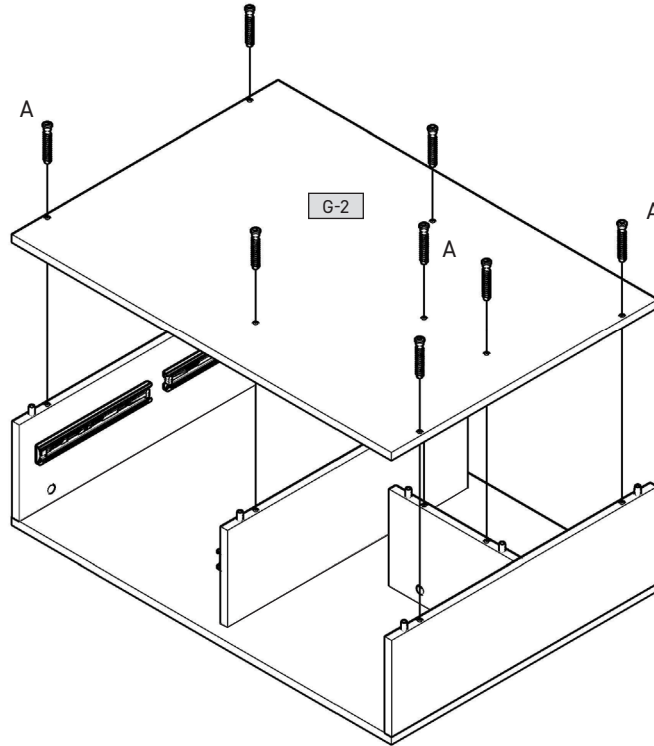
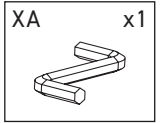
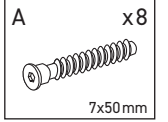

6

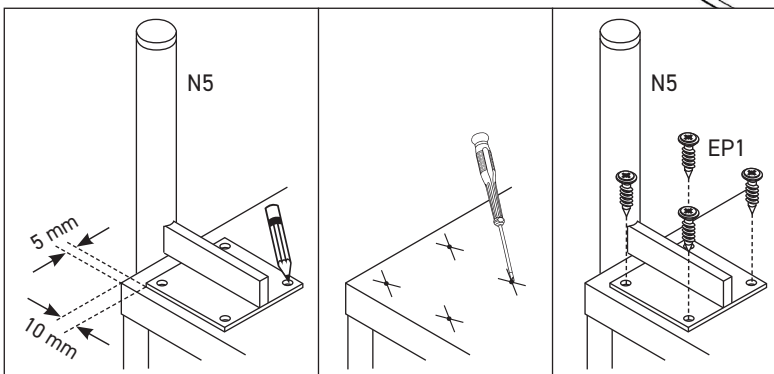
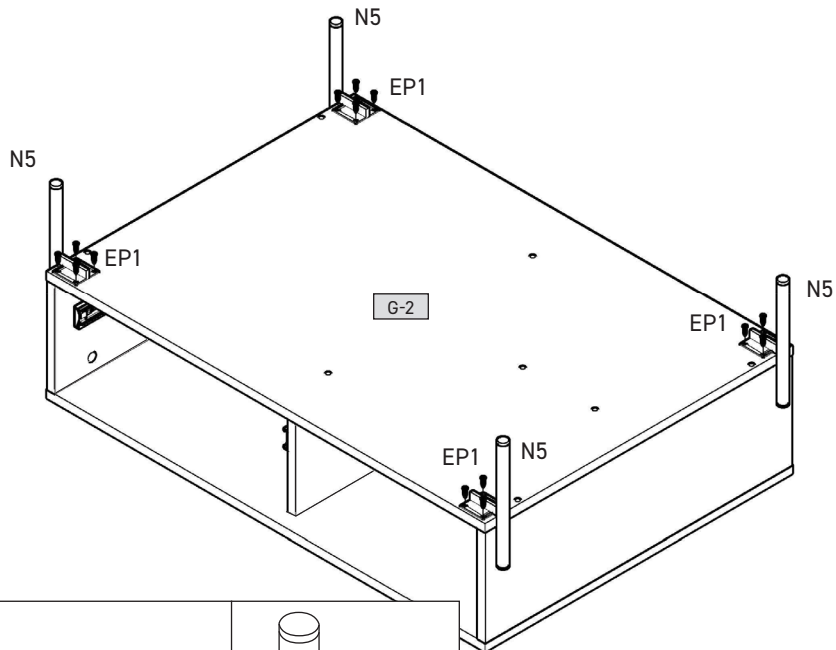
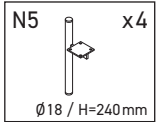
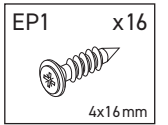

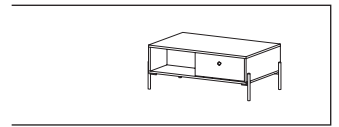

7

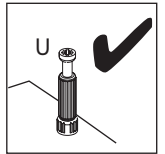
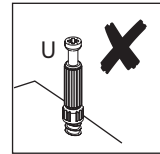
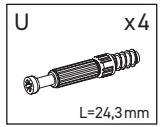
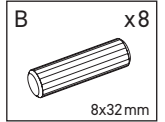
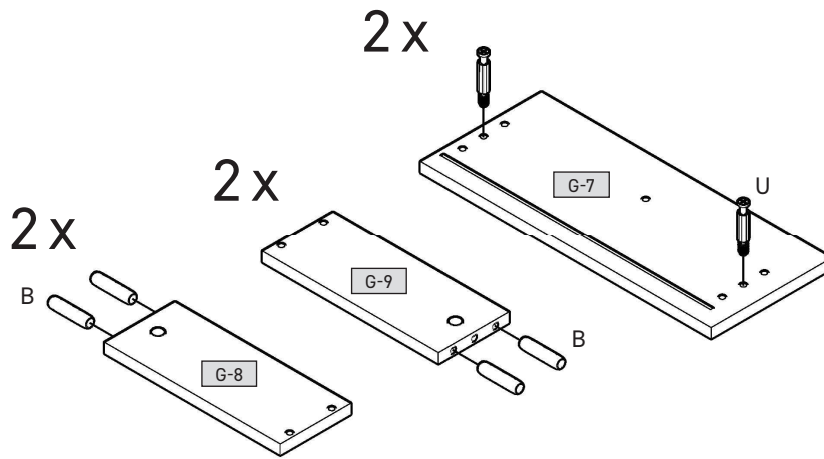

8

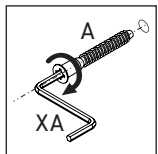
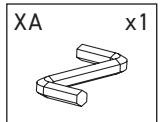
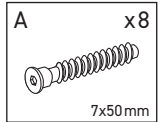
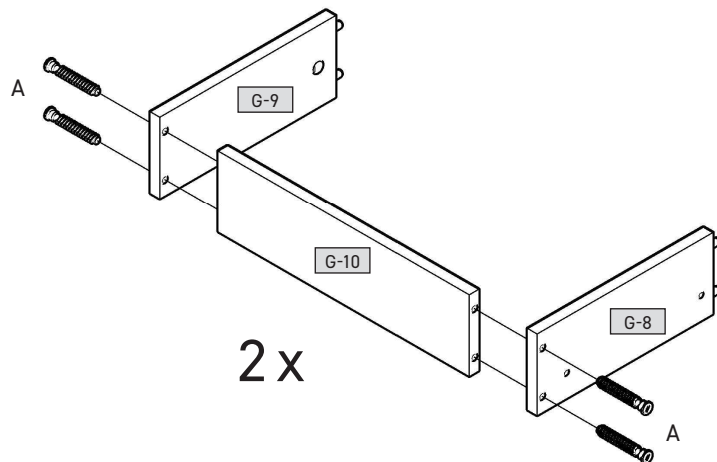

9

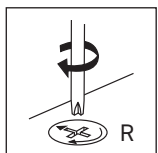
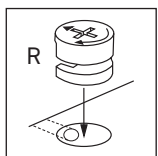
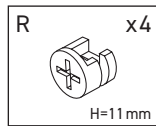
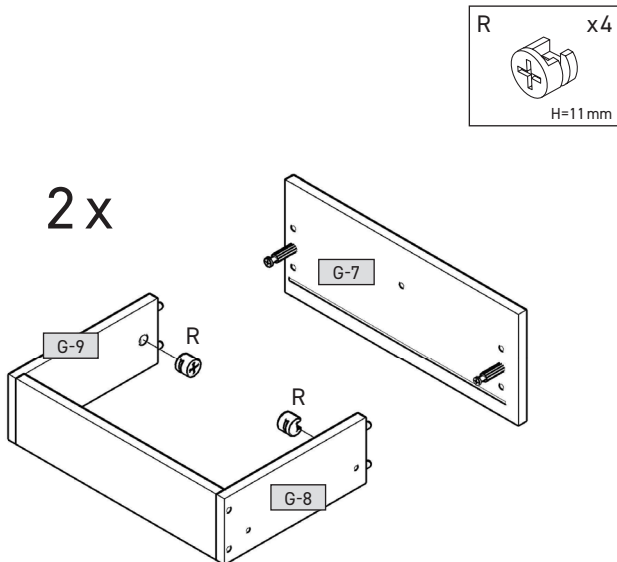

10

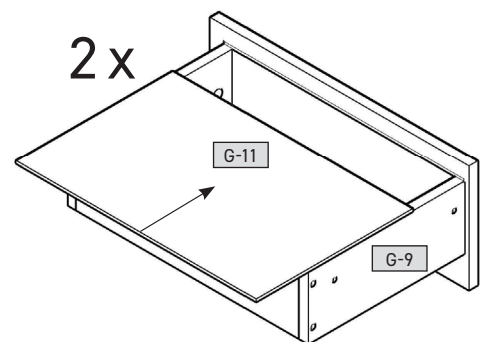



11

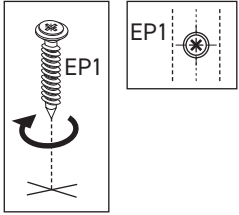
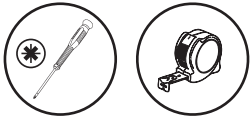

2 x

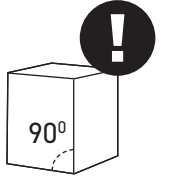
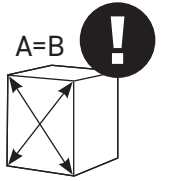
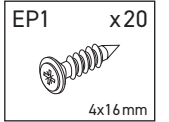
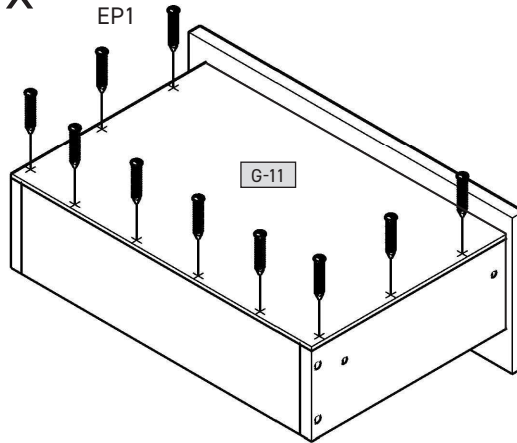

12

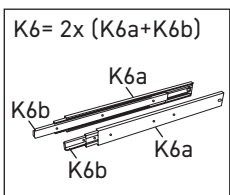

2 x

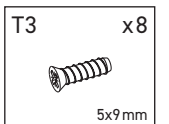
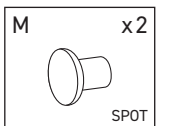
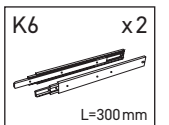
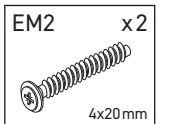
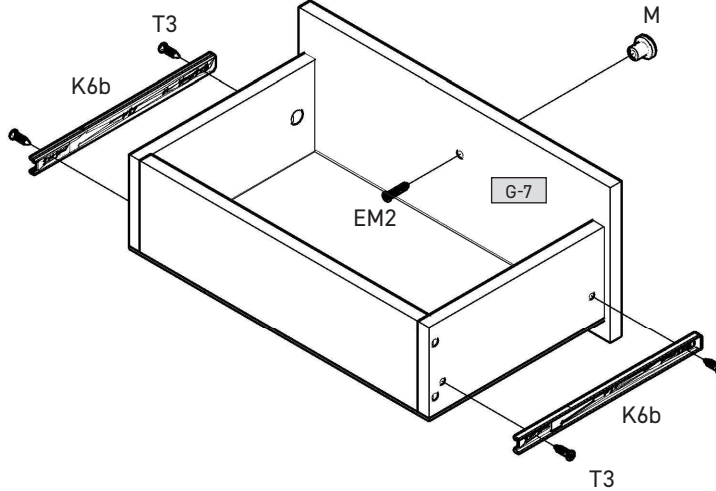

13

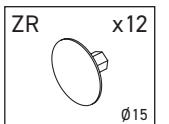
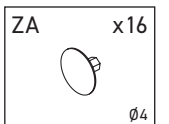
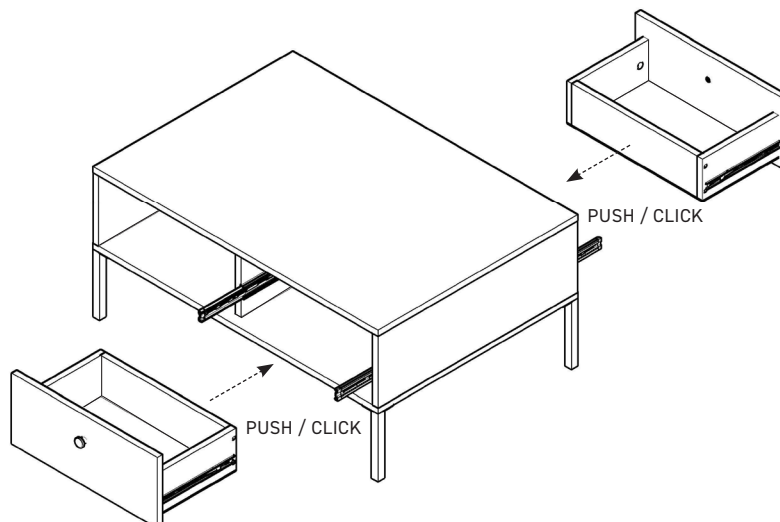
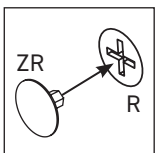
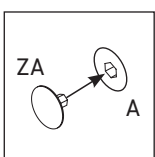

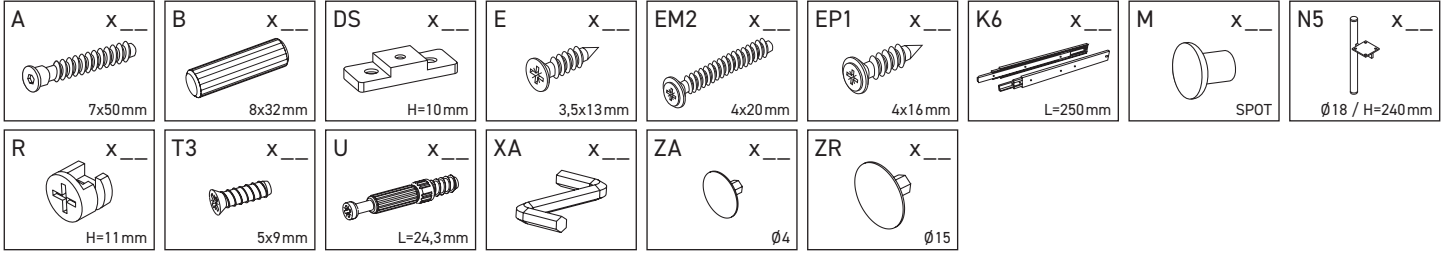

G-1	969	600	16	x 1	1/2
G-2	969	600	16	x 1	1/2
G-3	212	598	16	x 1	1/2
G-4	212	598	16	x 1	1/2
G-5	212	530	16	x 1	1/2
G-6	212	320	16	x 1	1/2
G-7	206	496	16	x 2	1/2
G-8	260	120	16	x 2	1/2
G-9	260	120	16	x 2	1/2
G-10	426	120	16	x 2	1/2
G-11	456	266	3	x 2	1/2

