

2023-05-10

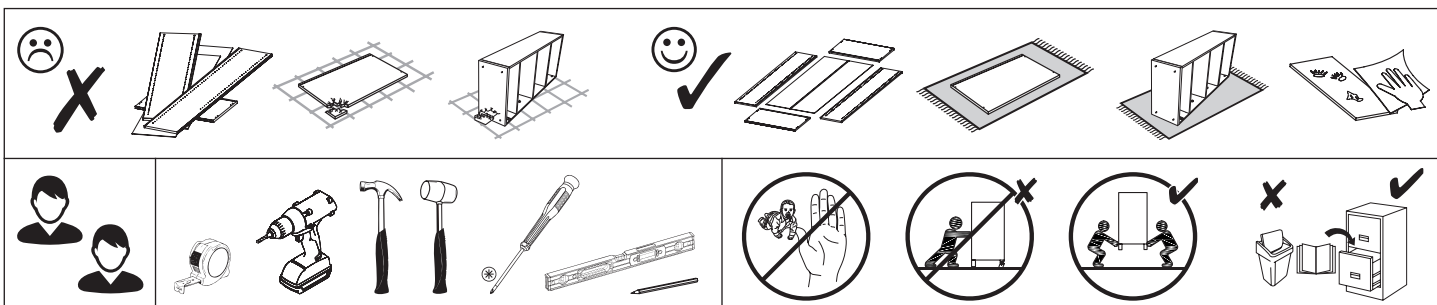

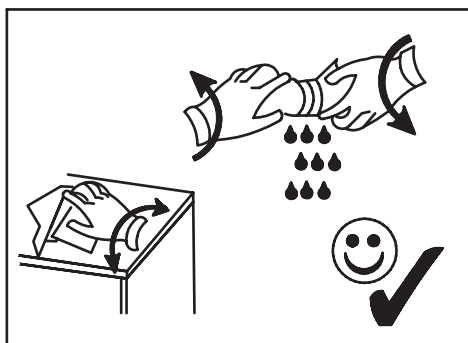

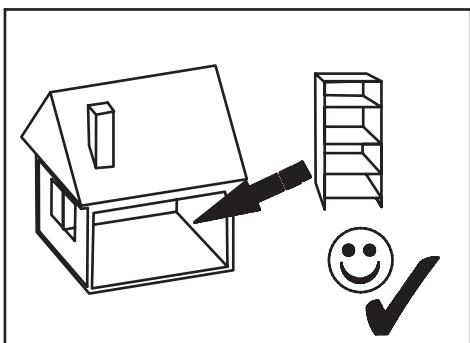
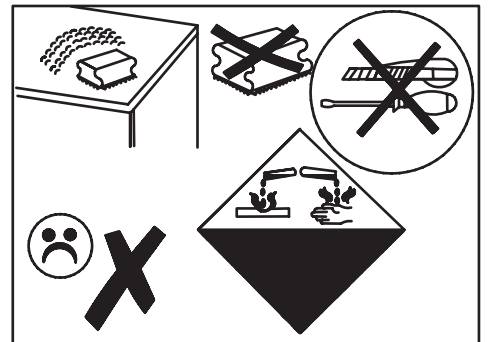
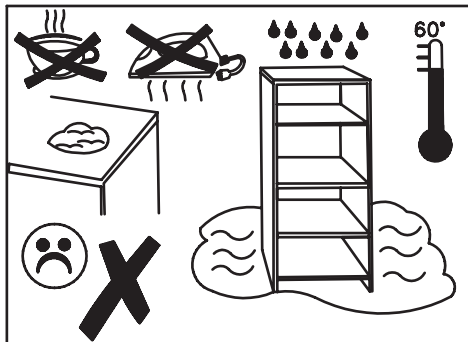
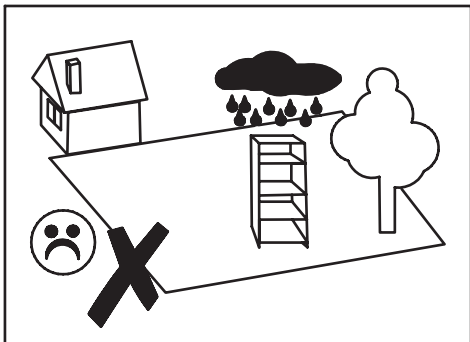
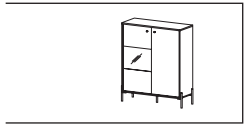
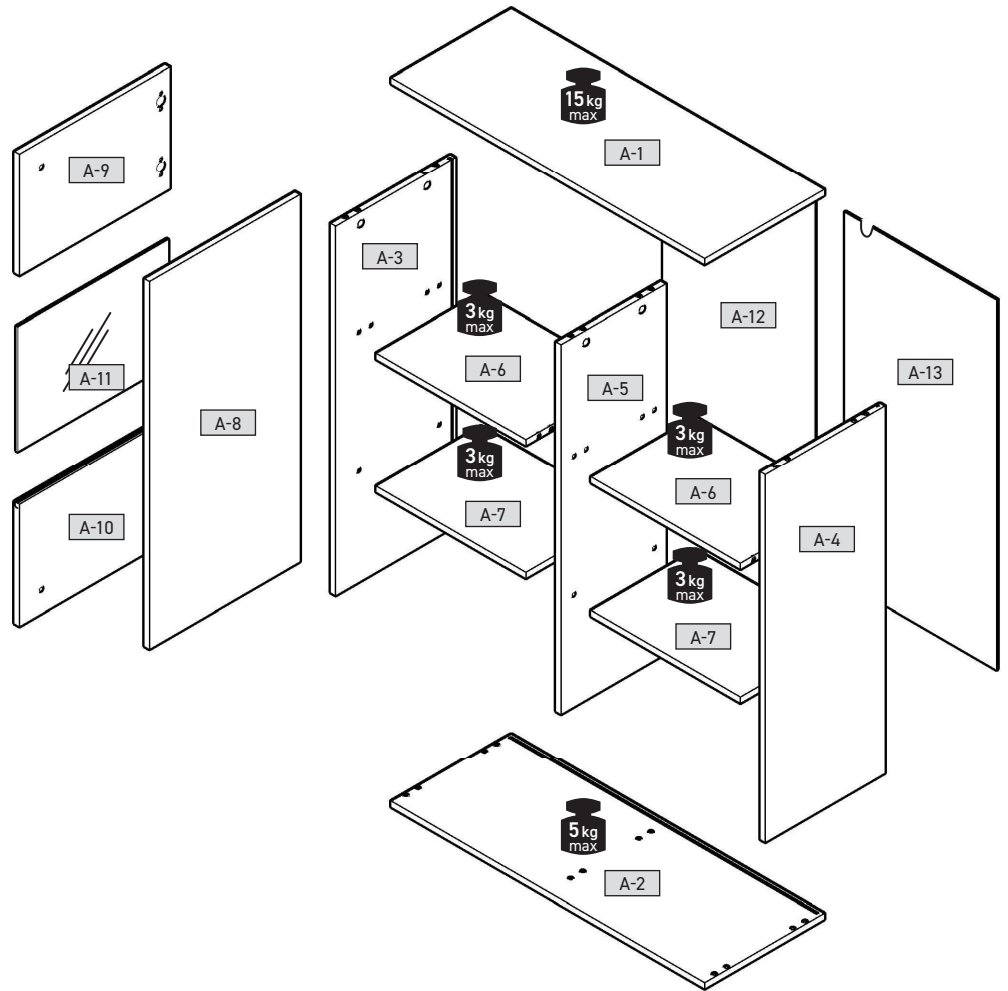
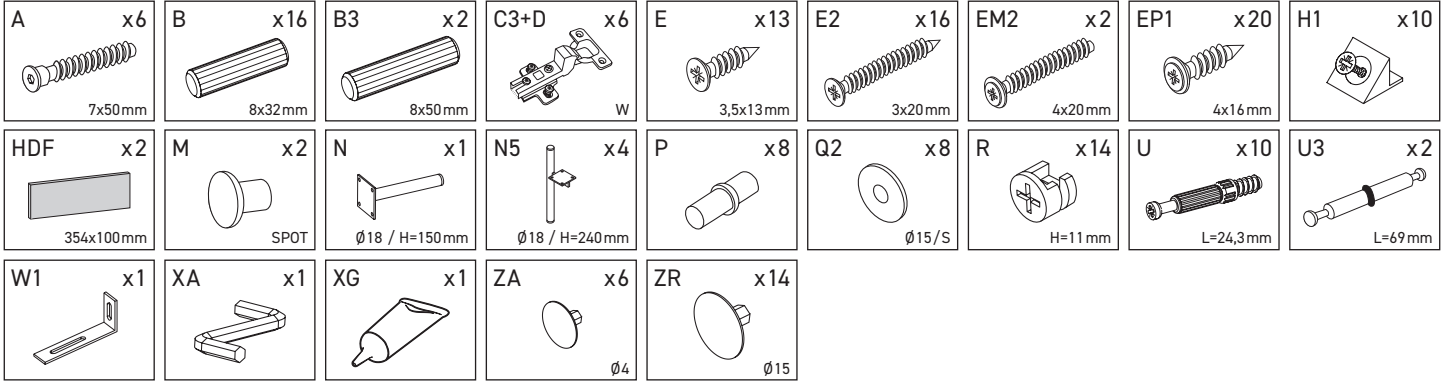

A-1	1033	395	16	x1	1/2
A-2	1033	395	16	x1	1/2
A-3	1052	394	16	x1	1/2
A-4	1052	394	16	x1	1/2
A-5	1052	345	16	x1	1/2
A-6	492	345	16	x2	1/2
A-7	492	345	16	x2	1/2
A-8	1046	496	16	x1	1/2
A-9	346	496	16	x1	1/2
A-10	346	496	16	x1	1/2
A-11	493	388	4	x1	1/2
A-12	507	1066	3	x1	1/2
A-13	507	1066	3	x1	1/2

2/2

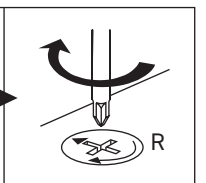
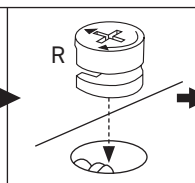
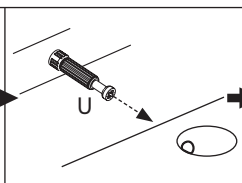
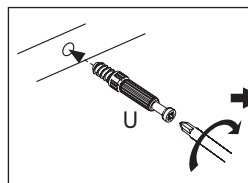
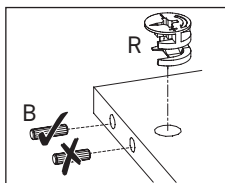
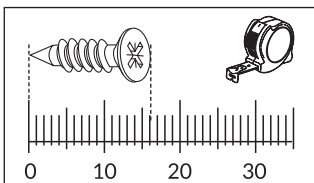
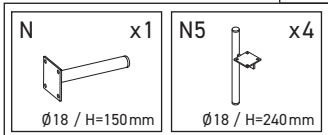



1

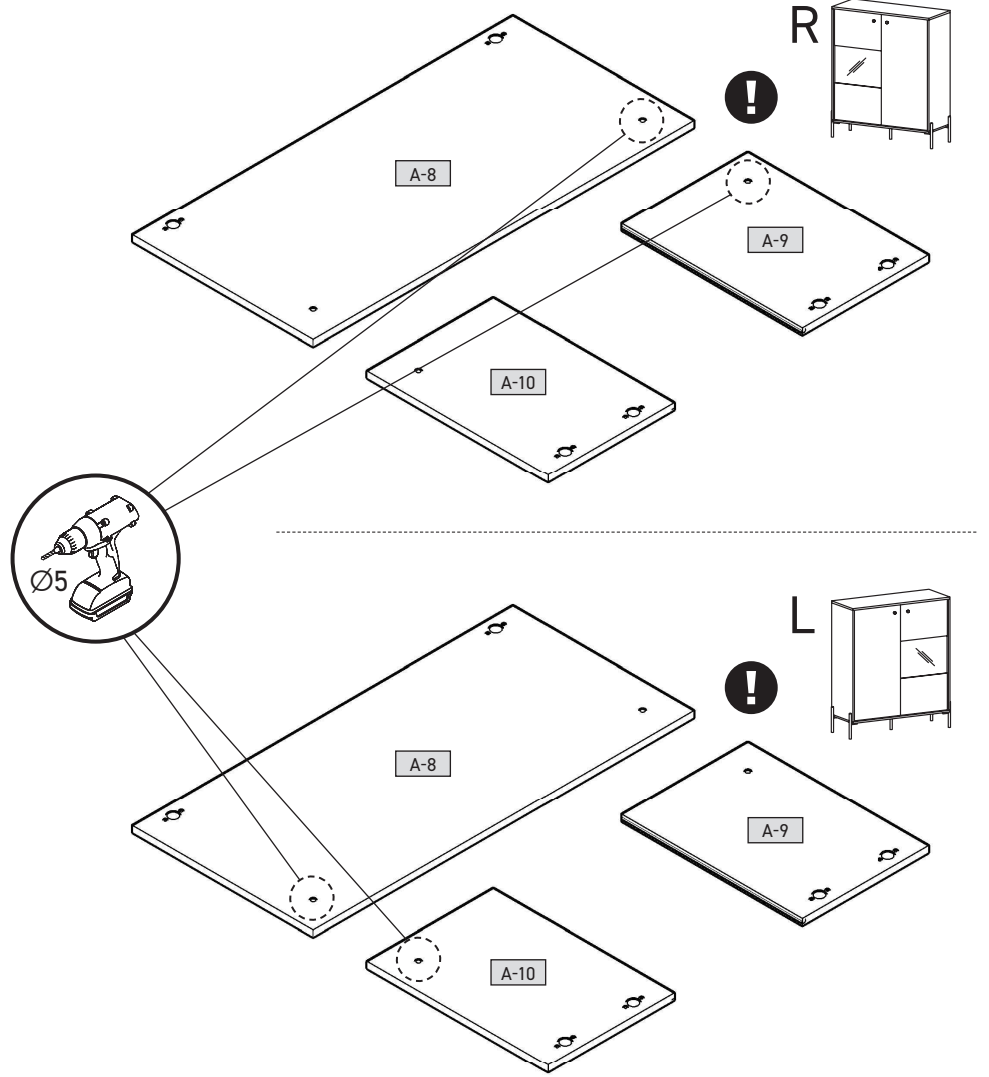
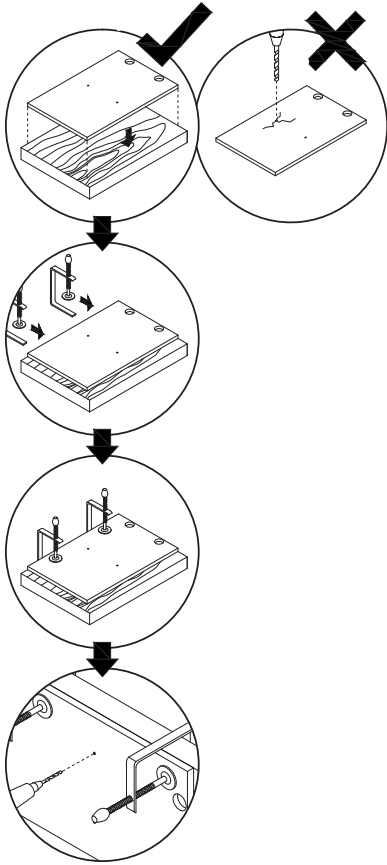

2

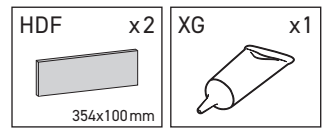
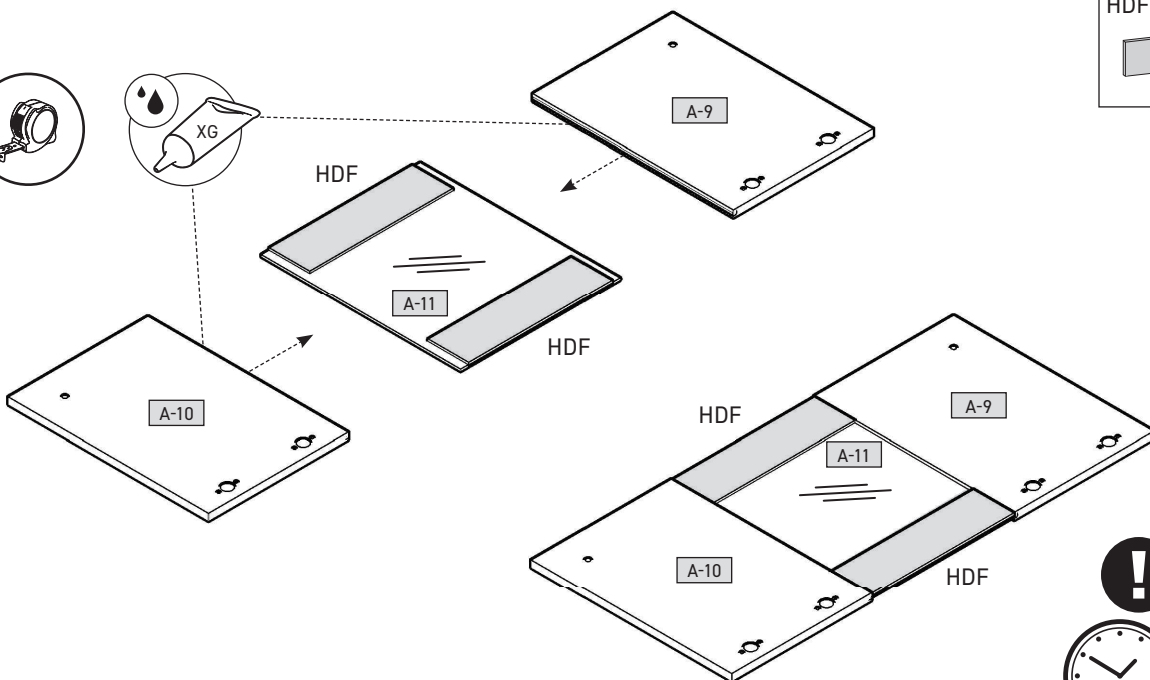

A=B

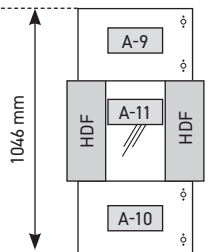
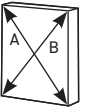



3

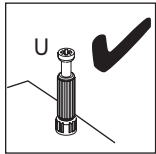
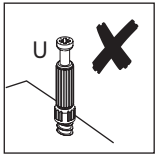
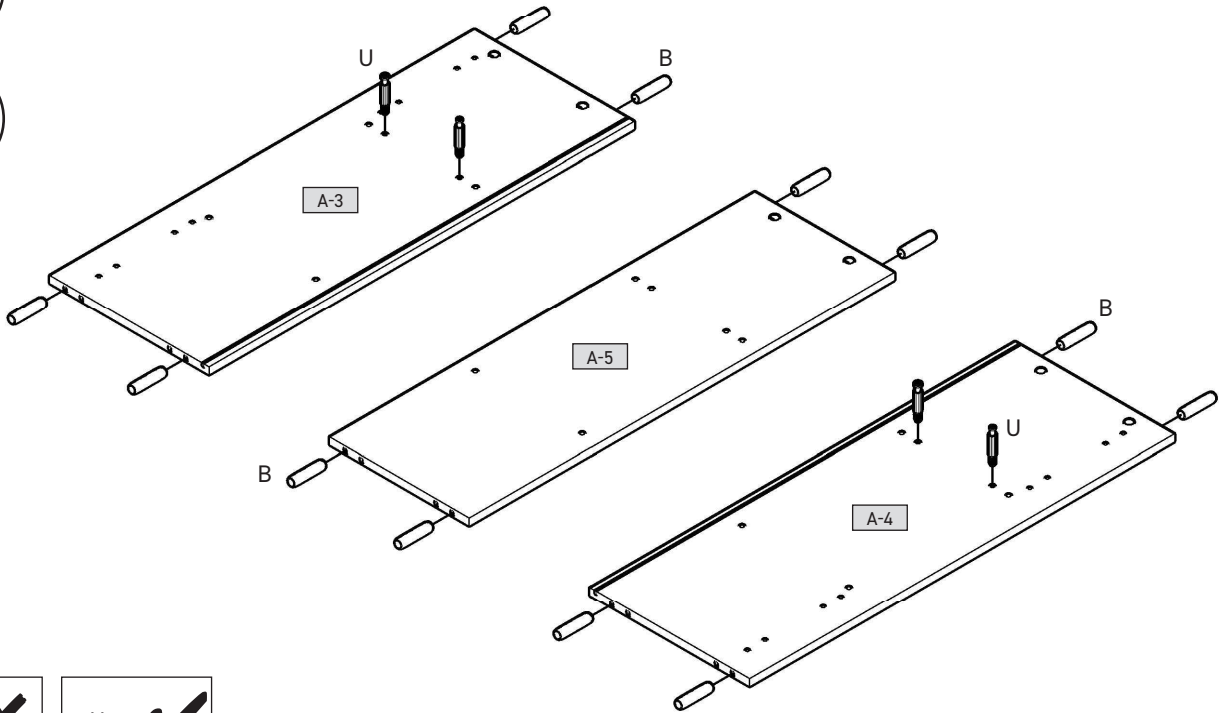
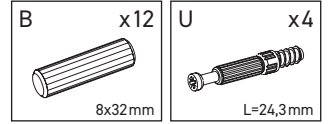

4

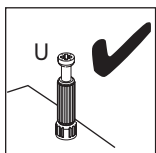
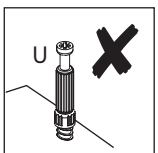
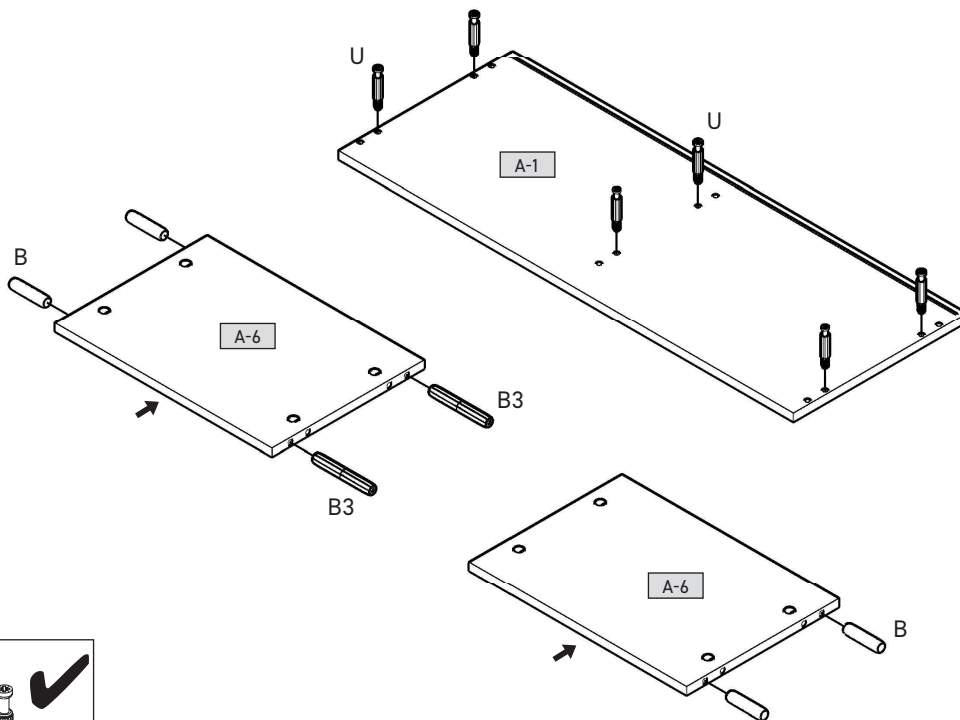
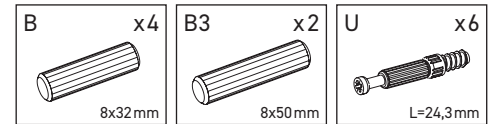



5

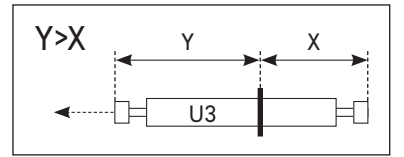
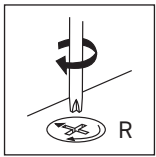
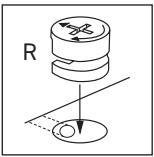
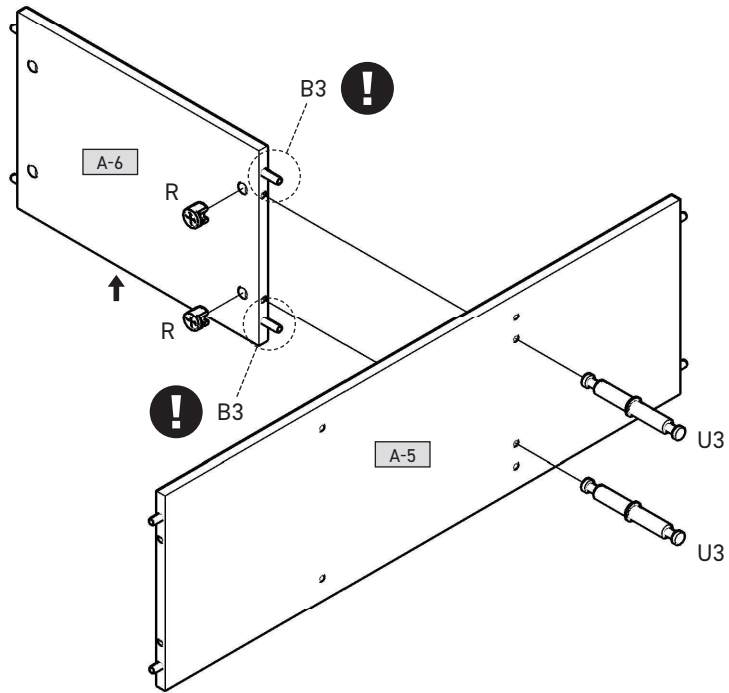
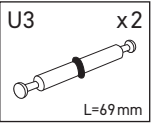
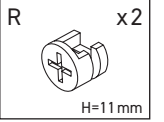

6

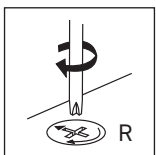
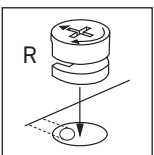
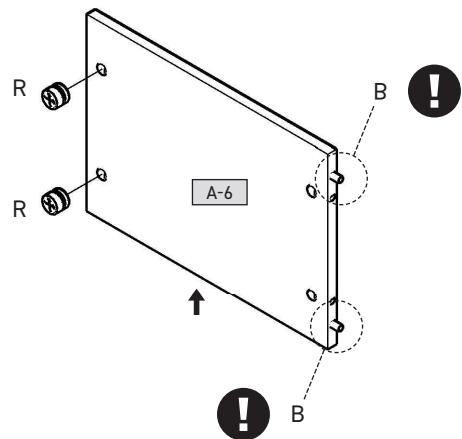
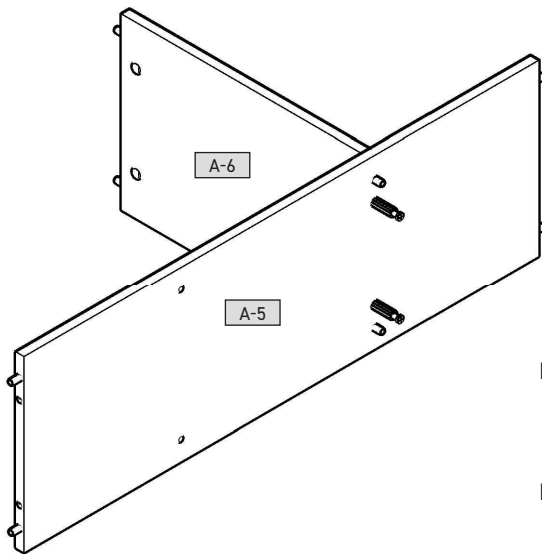
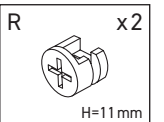

7

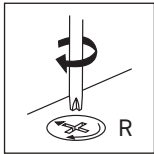
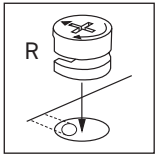
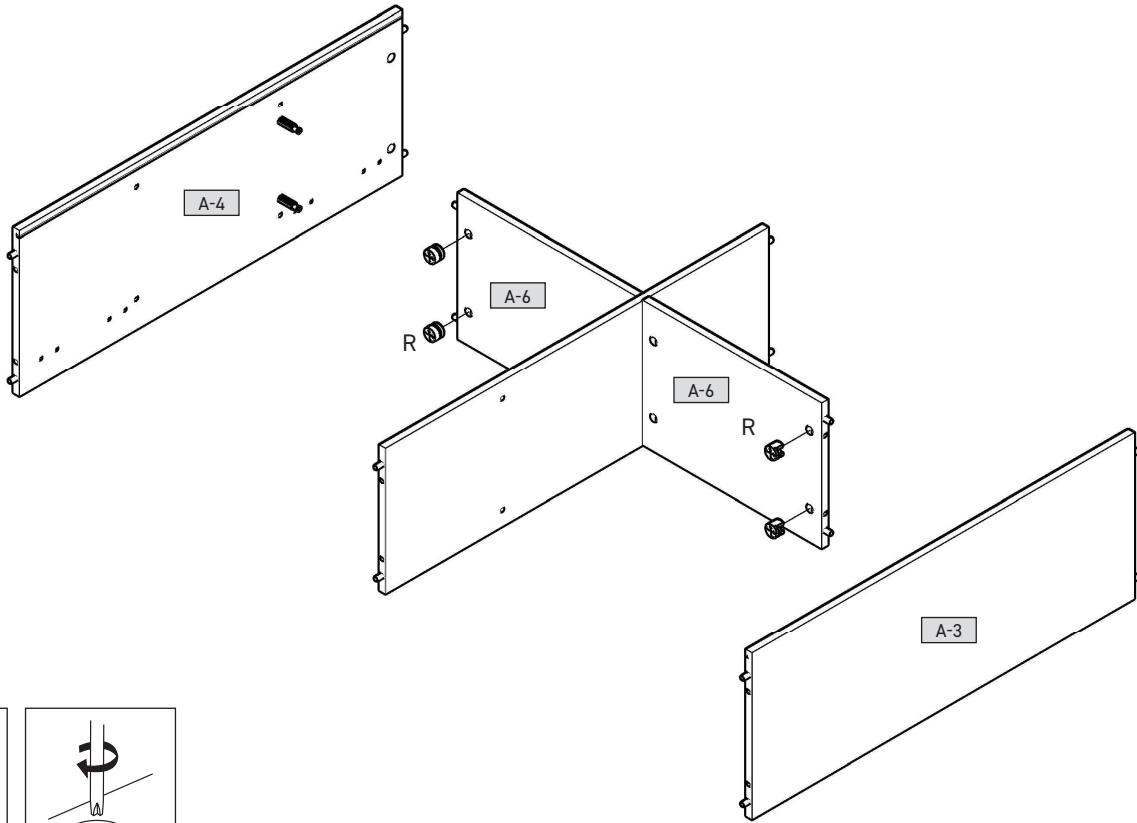
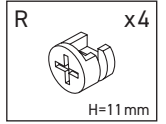

8

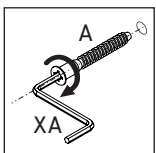
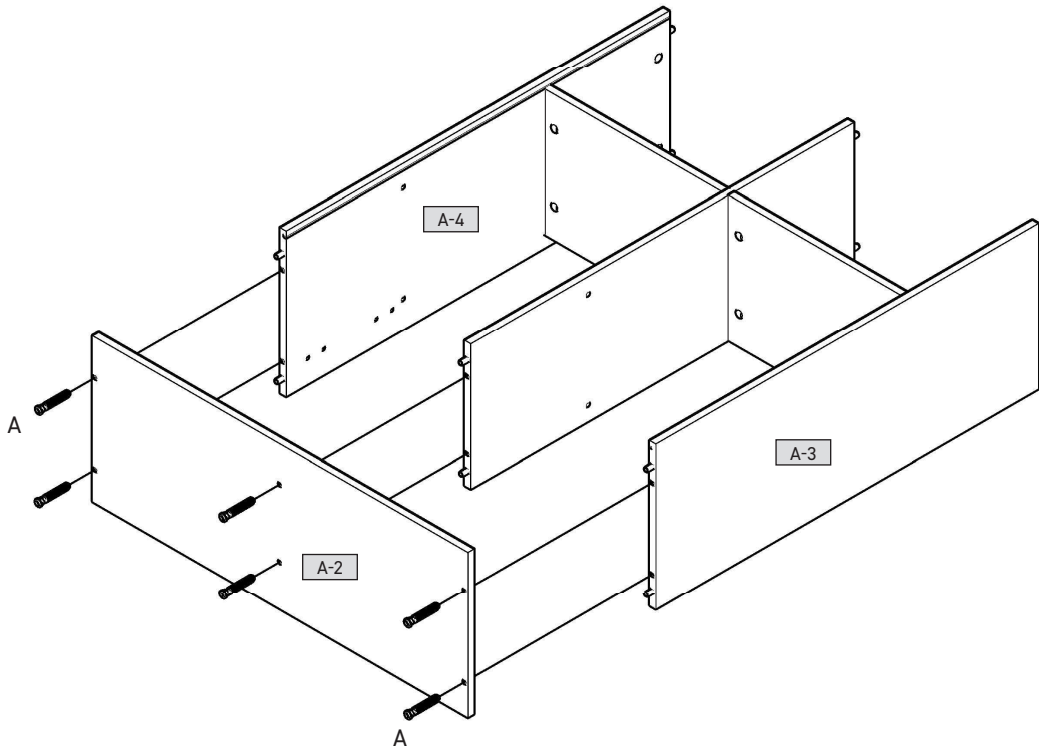
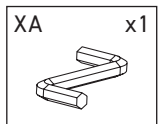
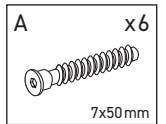

9

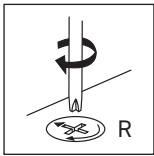
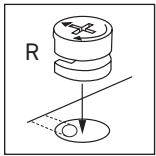
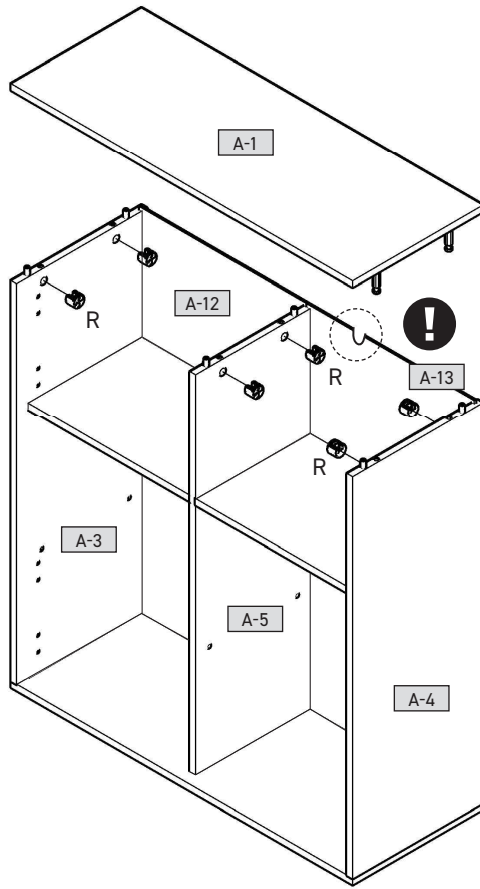
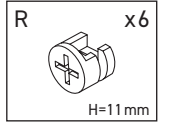

10

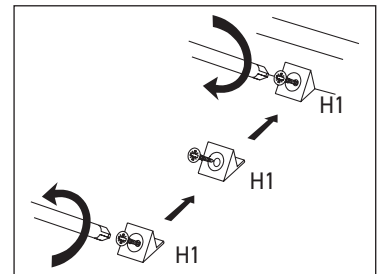
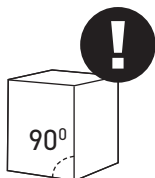
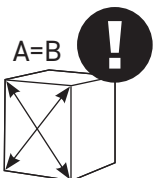
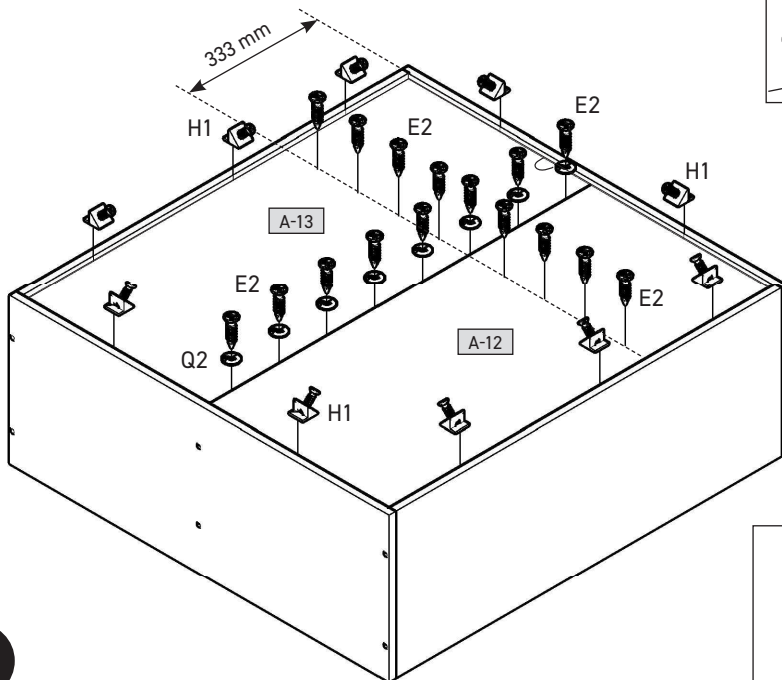
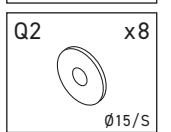
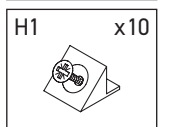
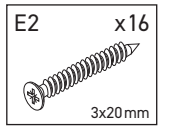
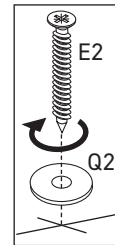
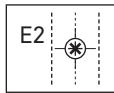
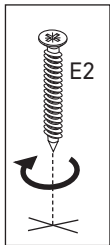
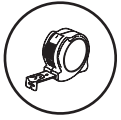



11

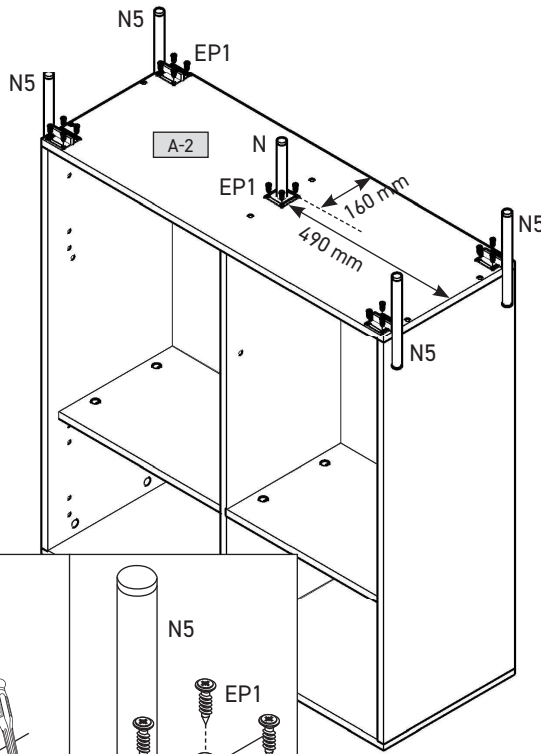

- EP1 x20
4x16mm
- N x1
Ø18 / H=150mm
- N5 x4
Ø18 / H=240mm
- ZA x6
Ø4
- ZR x14
Ø15

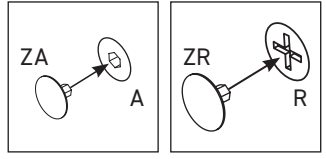
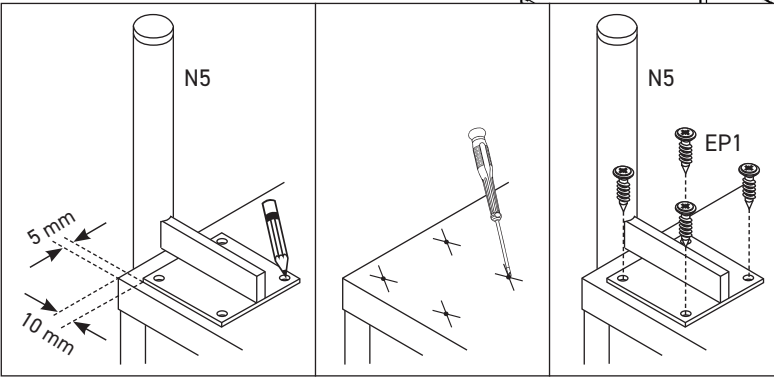

12

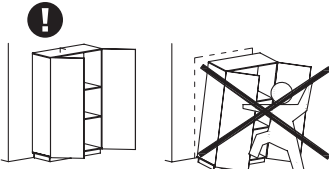
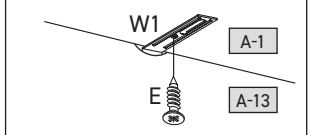
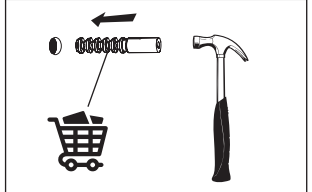
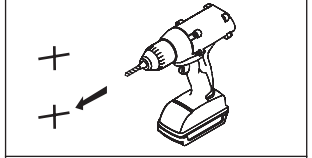
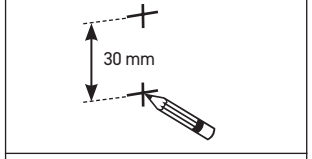
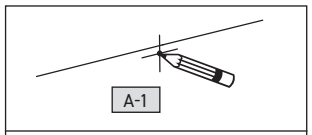
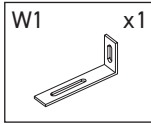
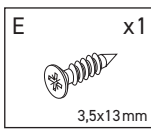
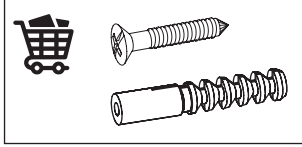
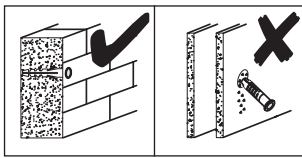
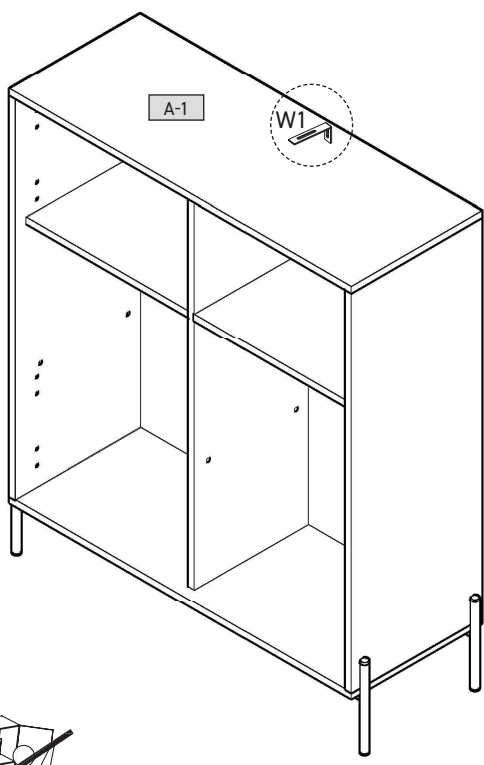

13 R

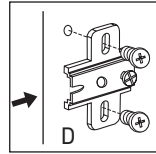
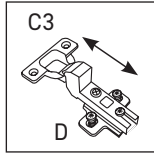
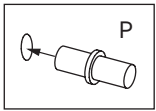
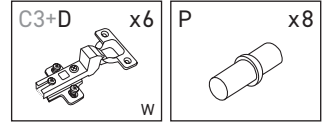
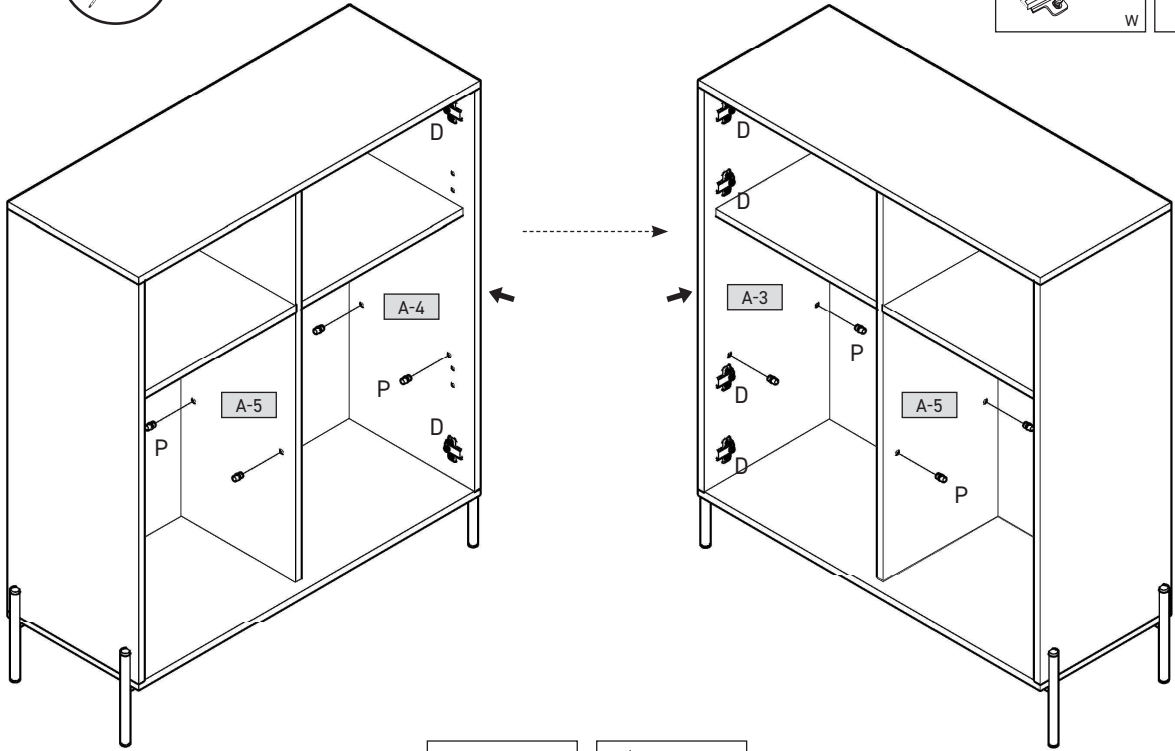

13 L

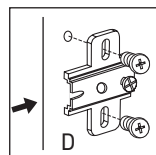
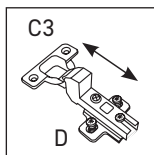
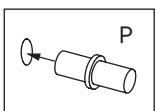
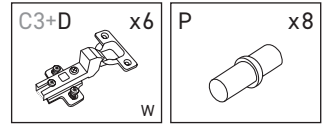
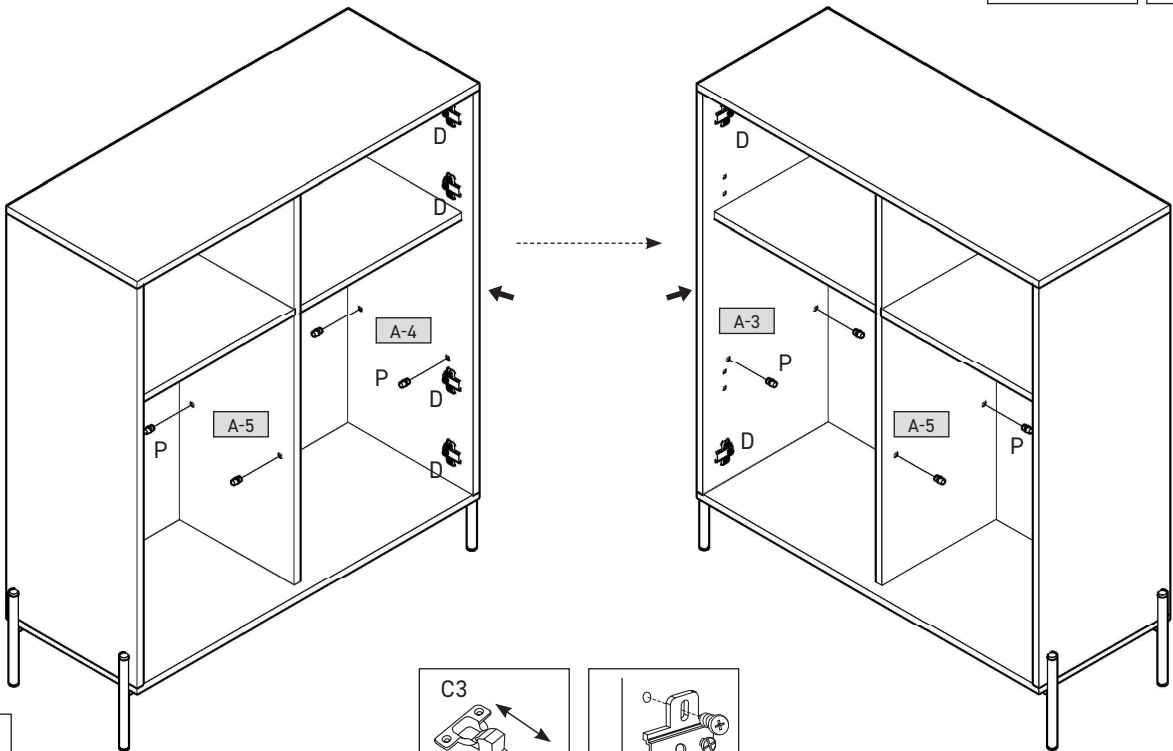

14

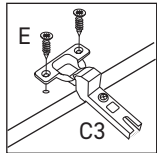
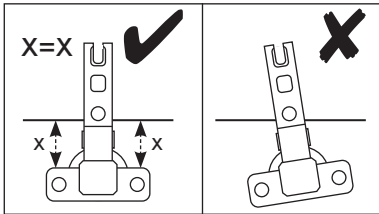
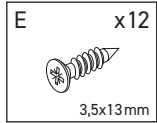
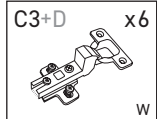
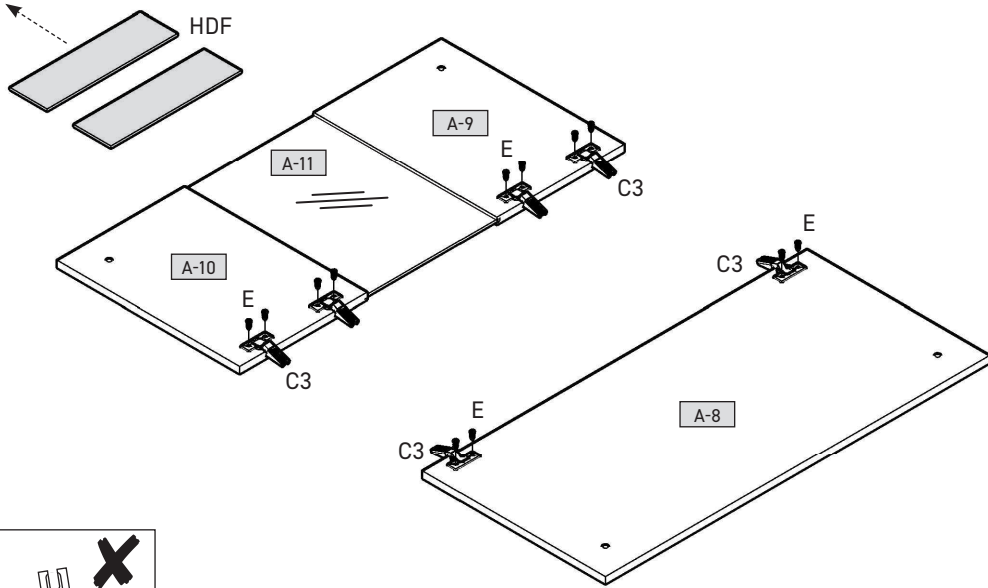

15

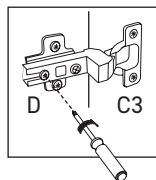
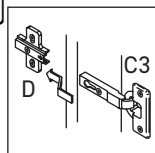
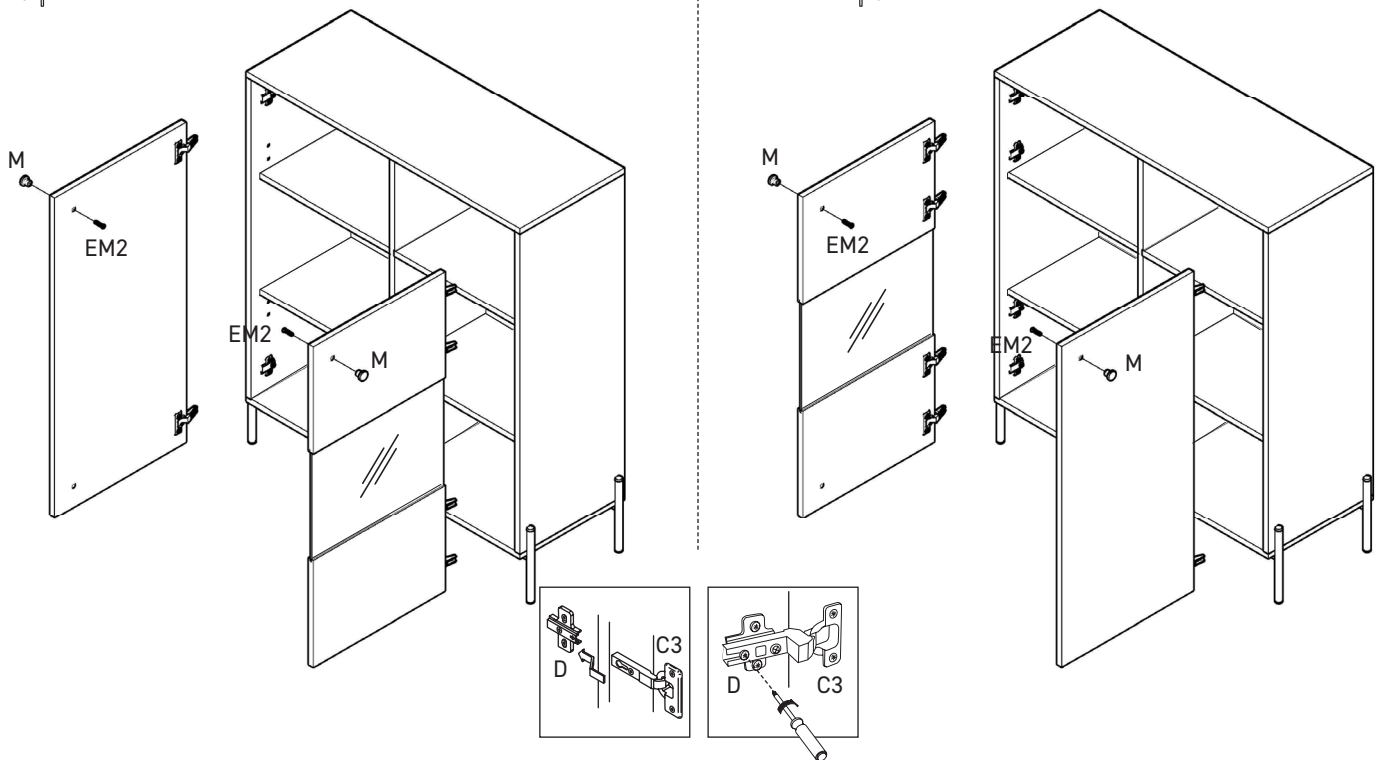
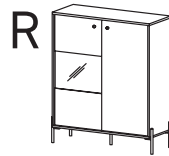
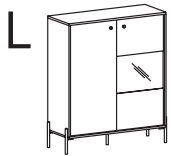
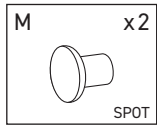
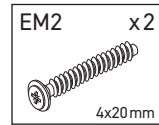



16

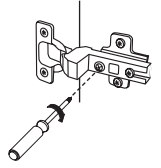
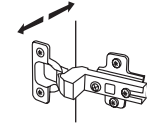
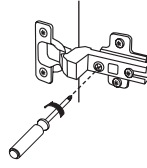
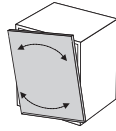
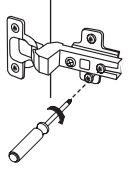
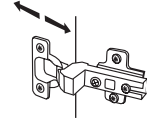
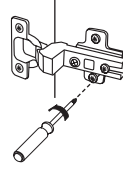
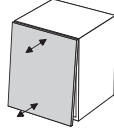
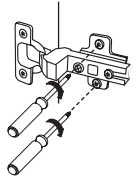
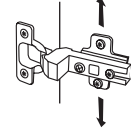
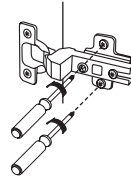
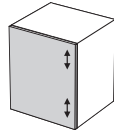
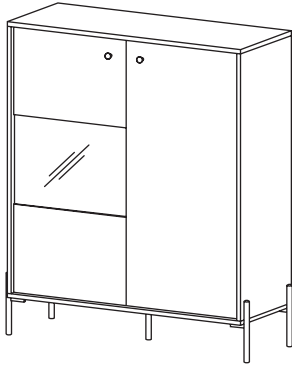

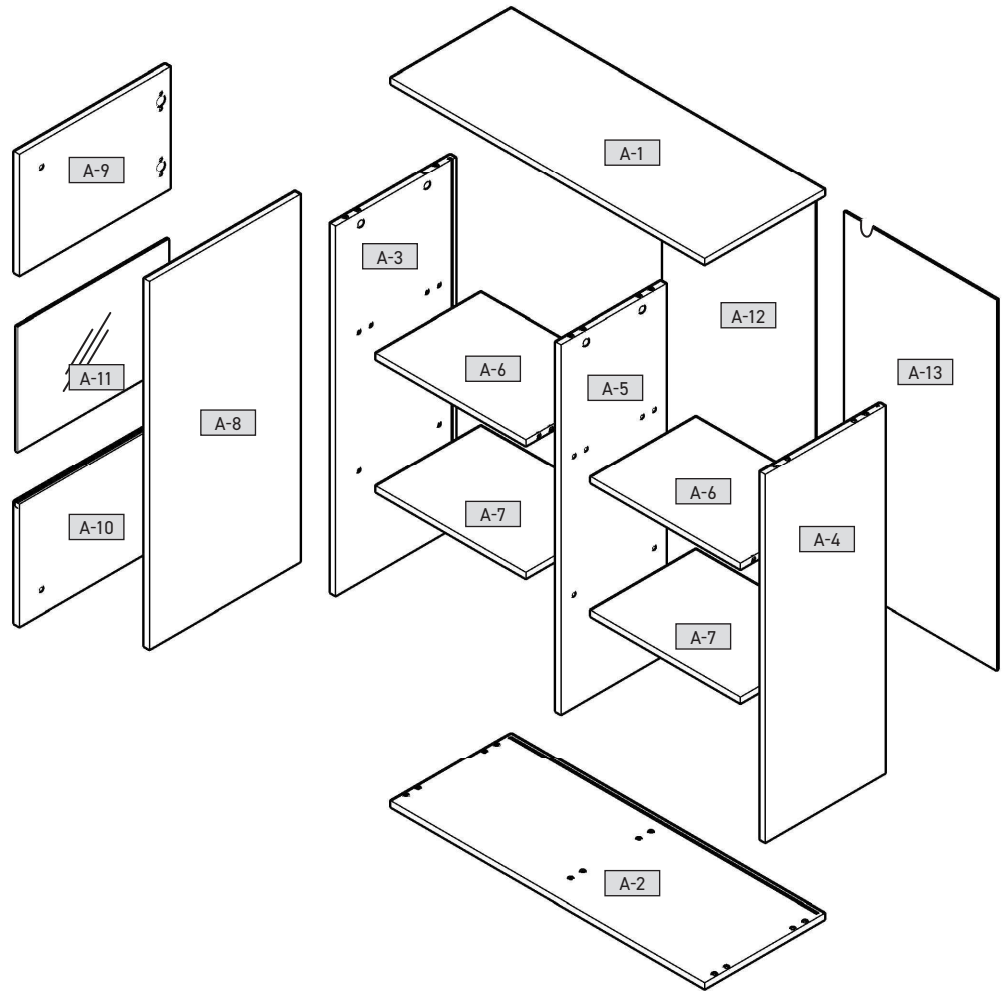
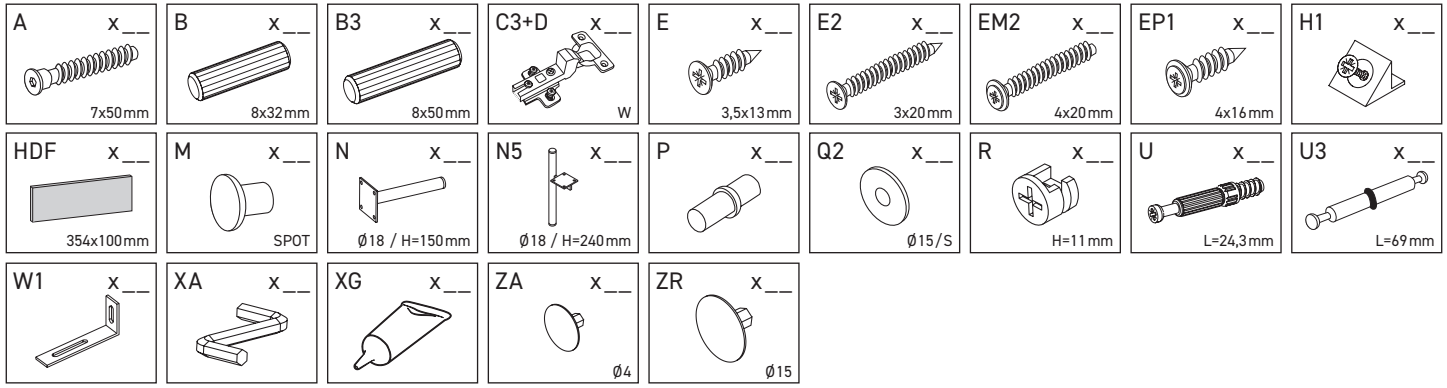

A-1	1033	395	16	x 1	1/2
A-2	1033	395	16	x 1	1/2
A-3	1052	394	16	x 1	1/2
A-4	1052	394	16	x 1	1/2
A-5	1052	345	16	x 1	1/2
A-6	492	345	16	x 2	1/2
A-7	492	345	16	x 2	1/2
A-8	1046	496	16	x 1	1/2
A-9	346	496	16	x 1	1/2
A-10	346	496	16	x 1	1/2
A-11	493	388	4	x 1	1/2
A-12	507	1066	3	x 1	1/2
A-13	507	1066	3	x 1	1/2

2/2

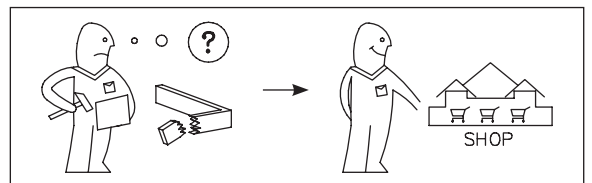
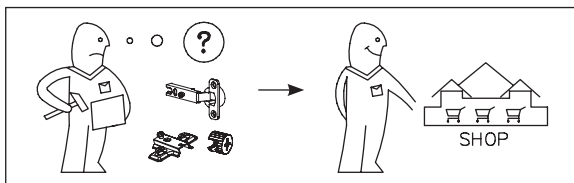
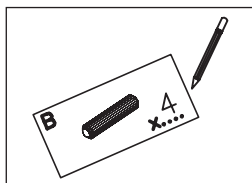
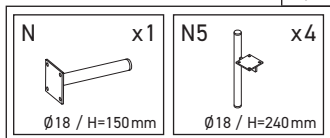

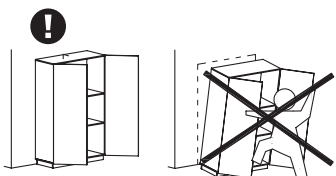
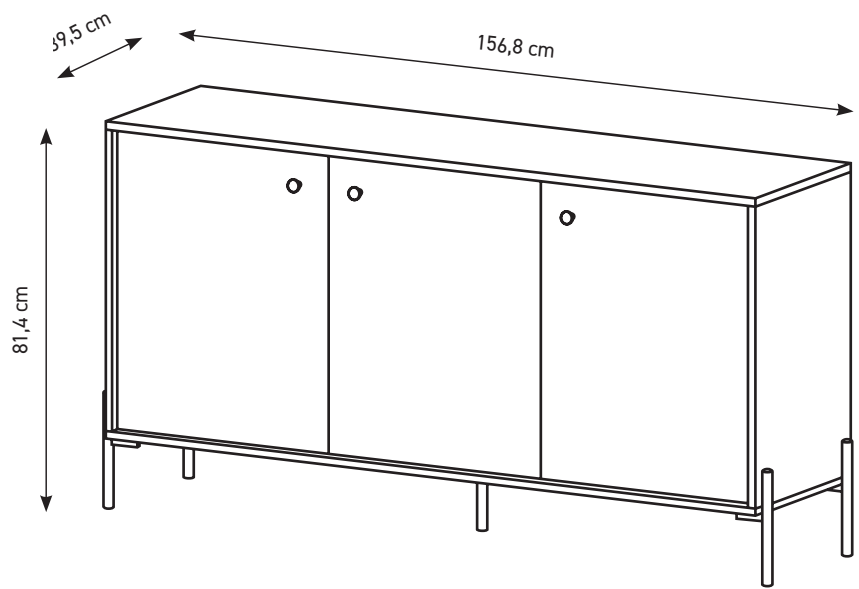

2023-05-08

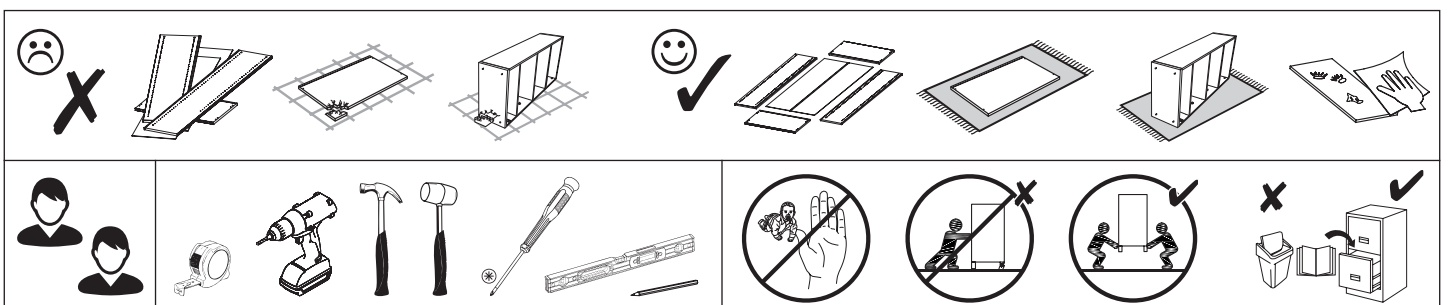

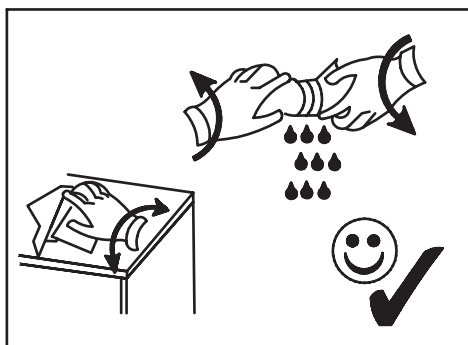
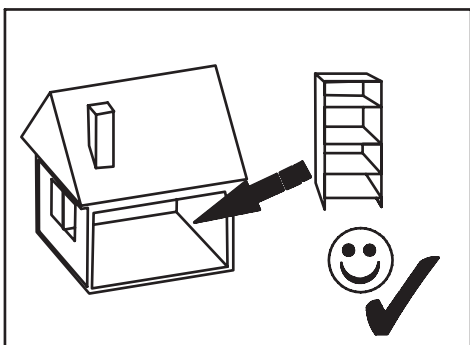
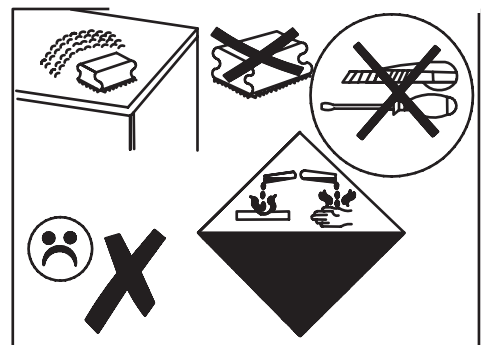
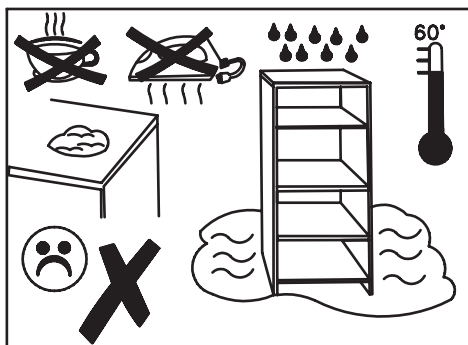
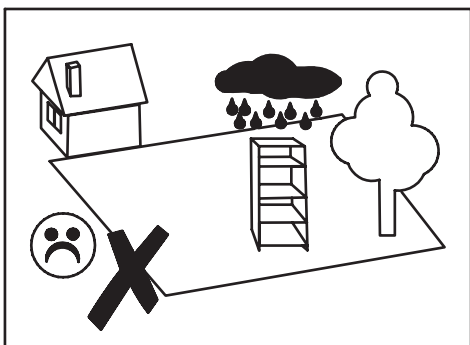
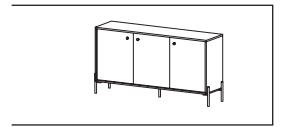

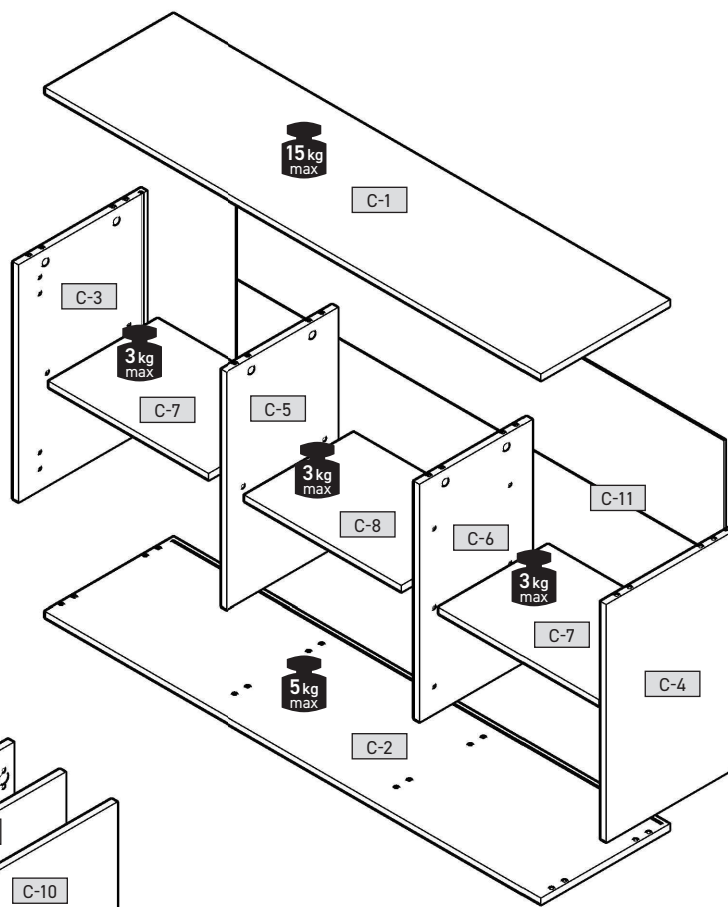
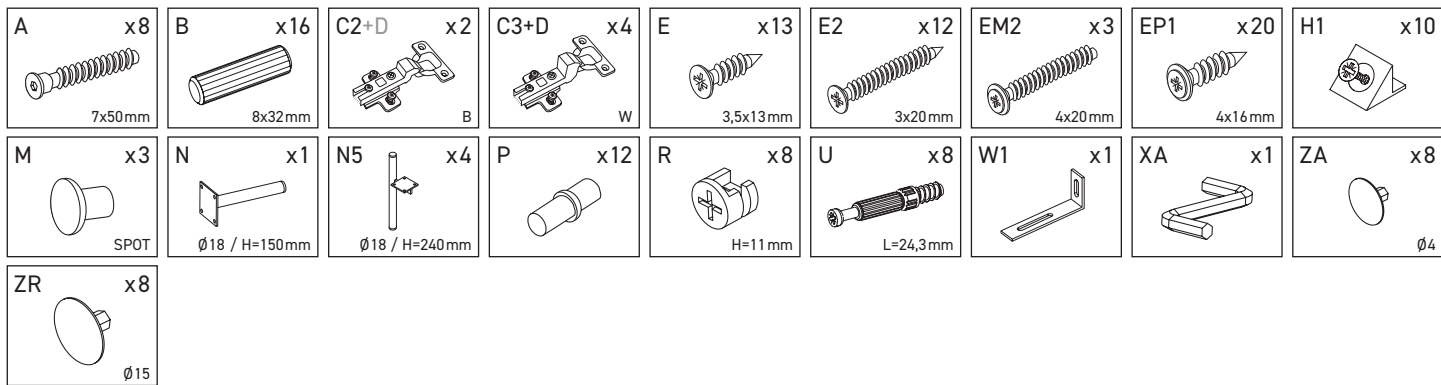
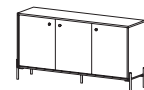

C-1	1531	395	16	x 1	1/3
C-2	1531	395	16	x 1	1/3
C-3	632	394	16	x 1	1/3
C-4	632	394	16	x 1	1/3
C-5	632	345	16	x 1	1/3
C-6	632	345	16	x 1	1/3
C-7	492	335	16	x 2	1/3
C-8	482	335	16	x 1	1/3
C-9	626	496	16	x 1	2/3
C-10	626	496	16	x 2	2/3
C-11	1512	646	3	x 1	1/3

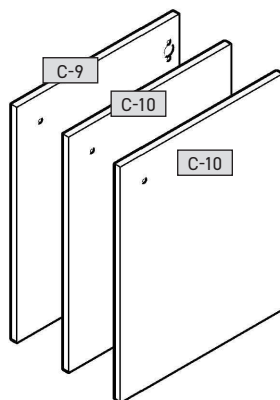

3/3

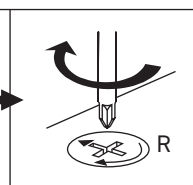
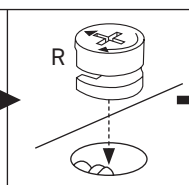
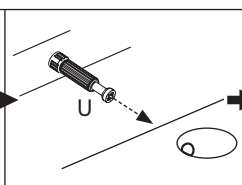
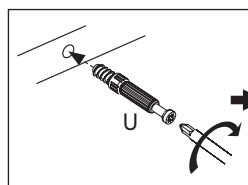
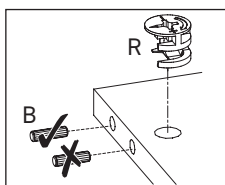
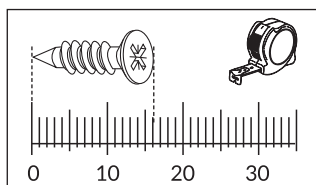
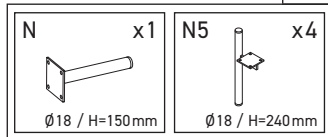

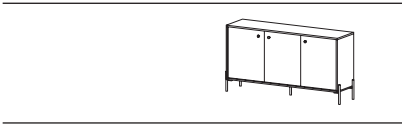

1

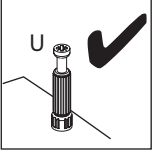
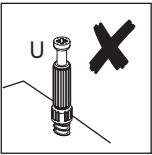
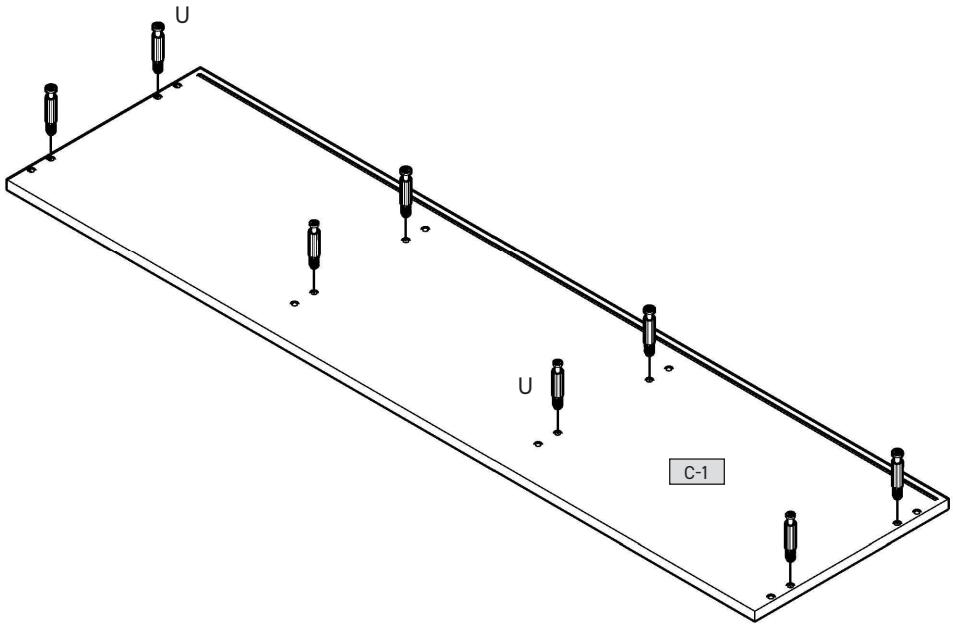
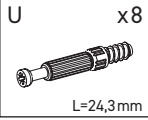

2

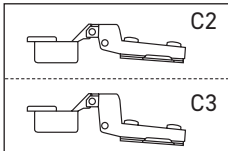
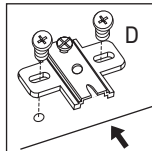
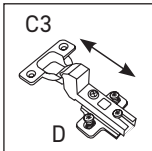
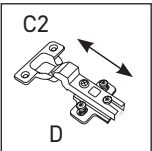
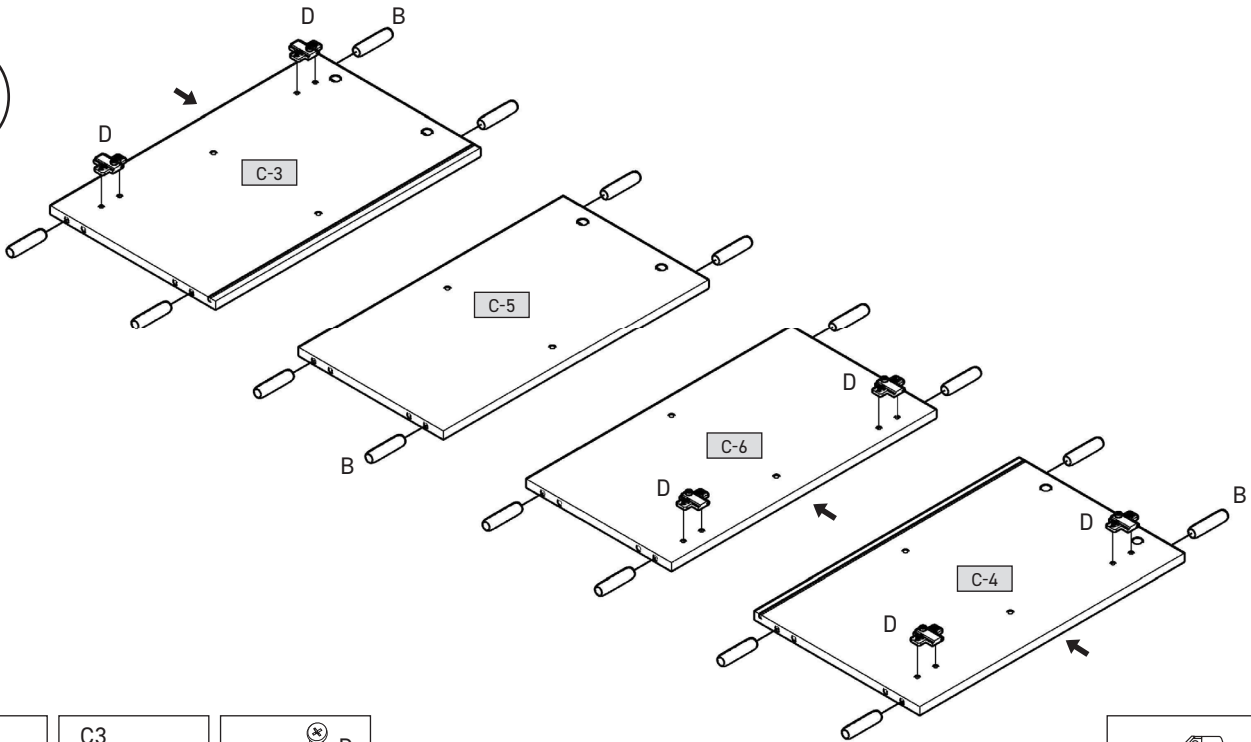
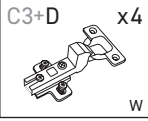
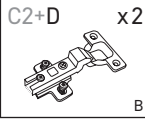
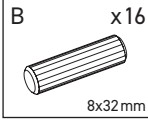

3

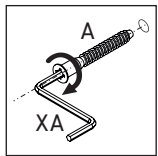
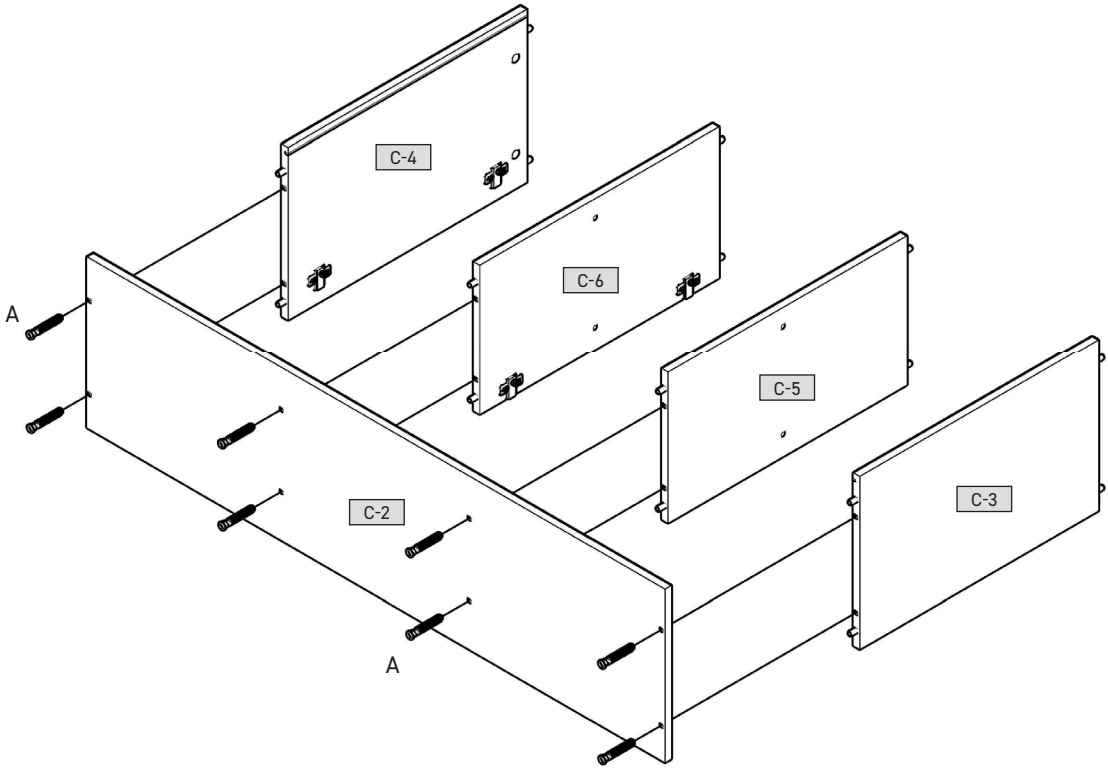
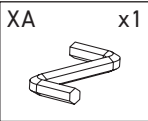
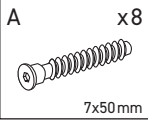
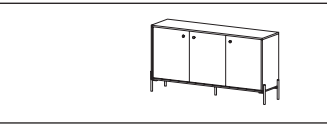

4

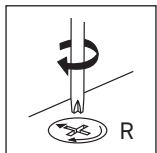
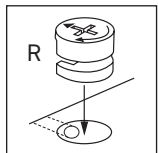
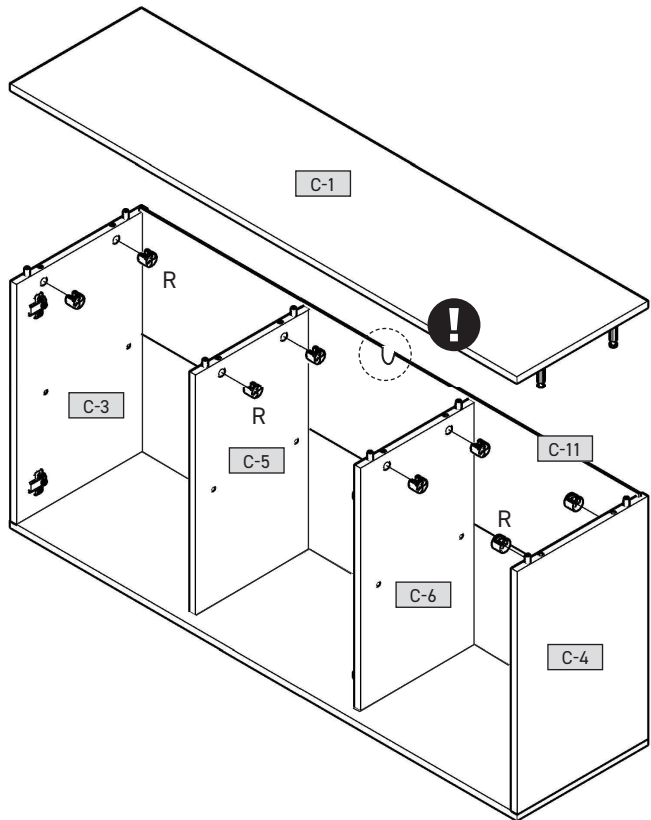
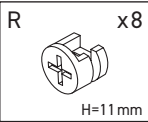

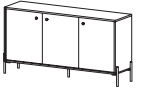

5

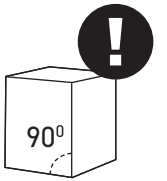
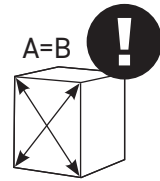
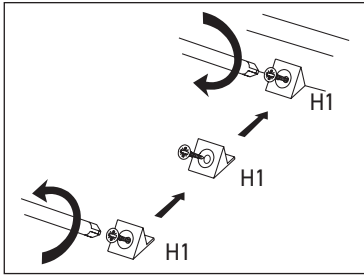
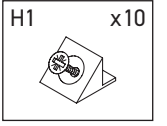
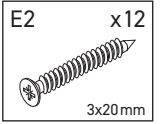
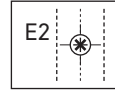
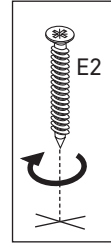
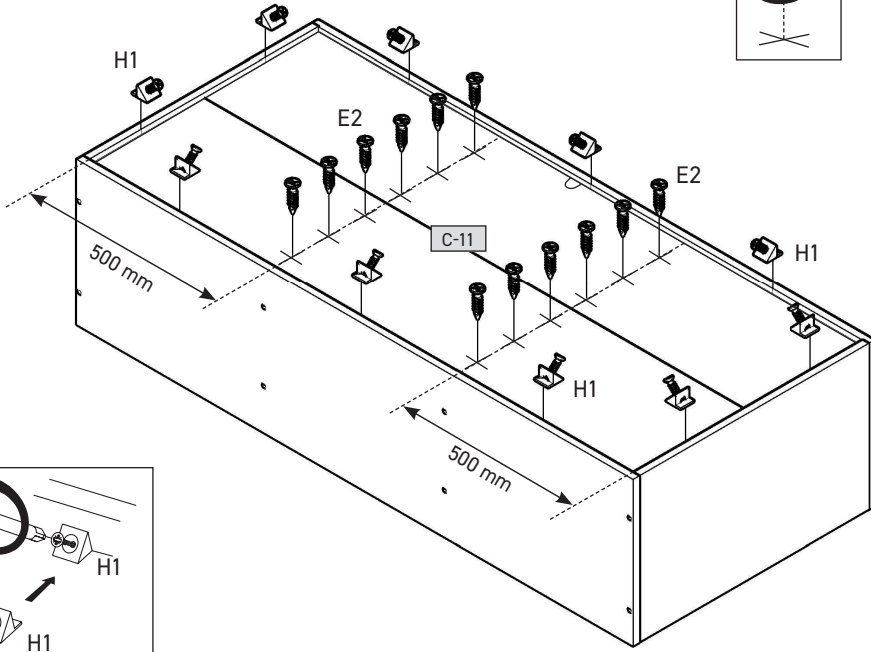
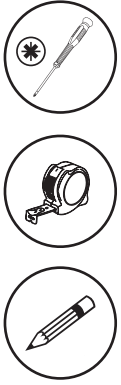

6

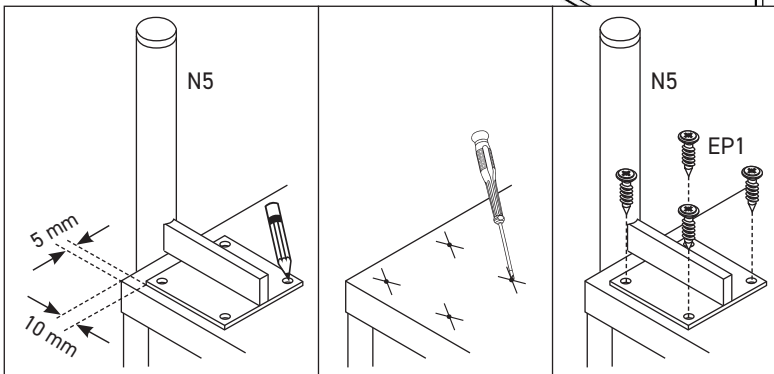
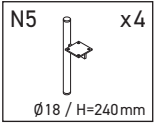
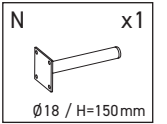
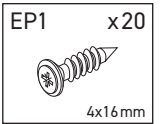
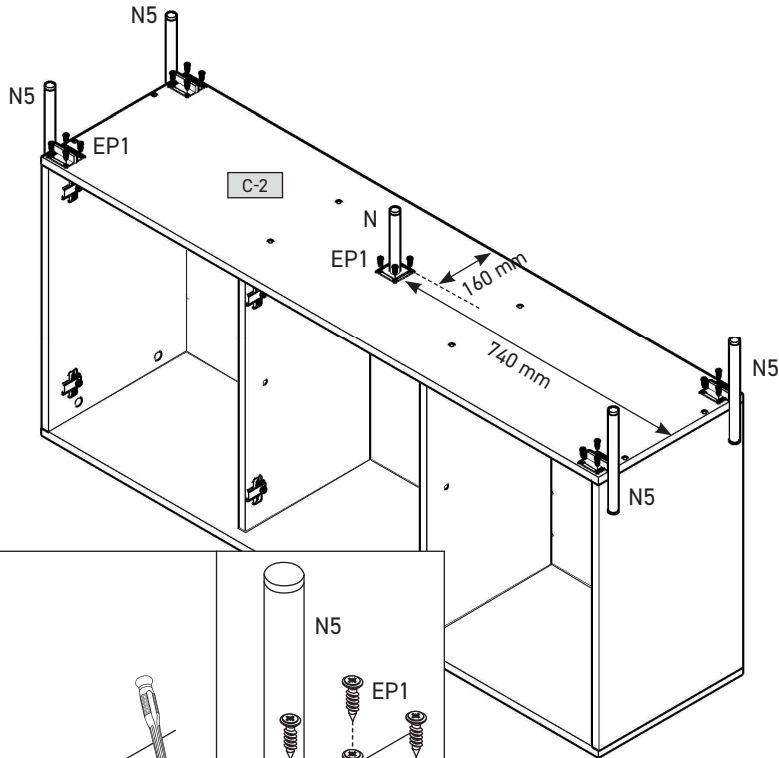

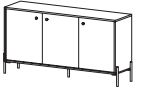

7

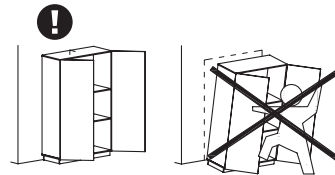
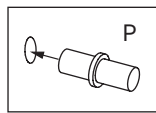
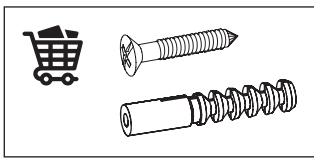
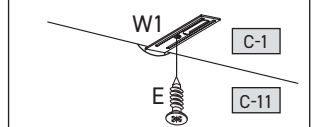
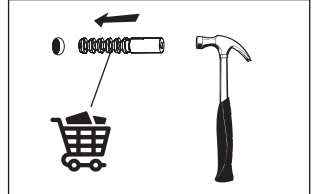
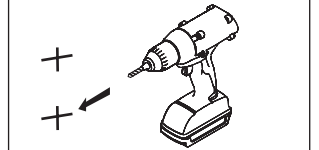
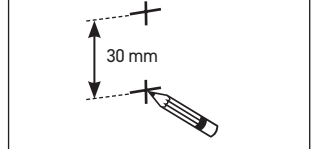
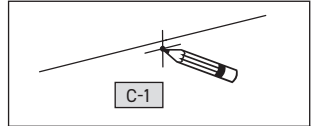
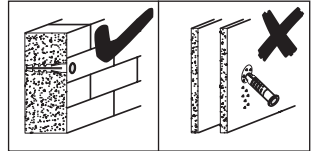
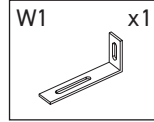
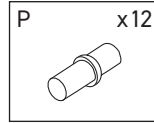
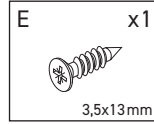
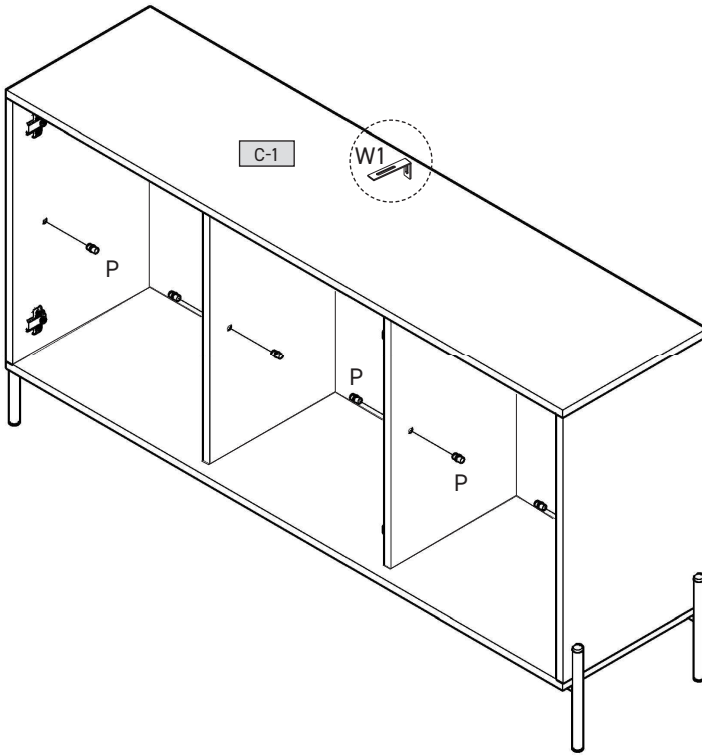

8

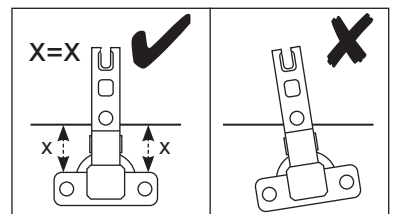
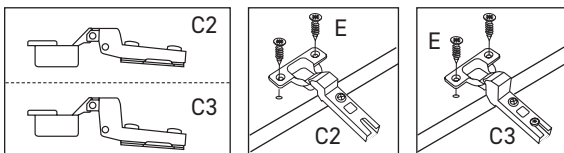
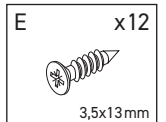
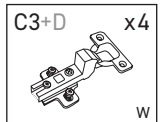
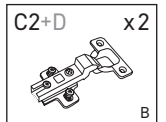
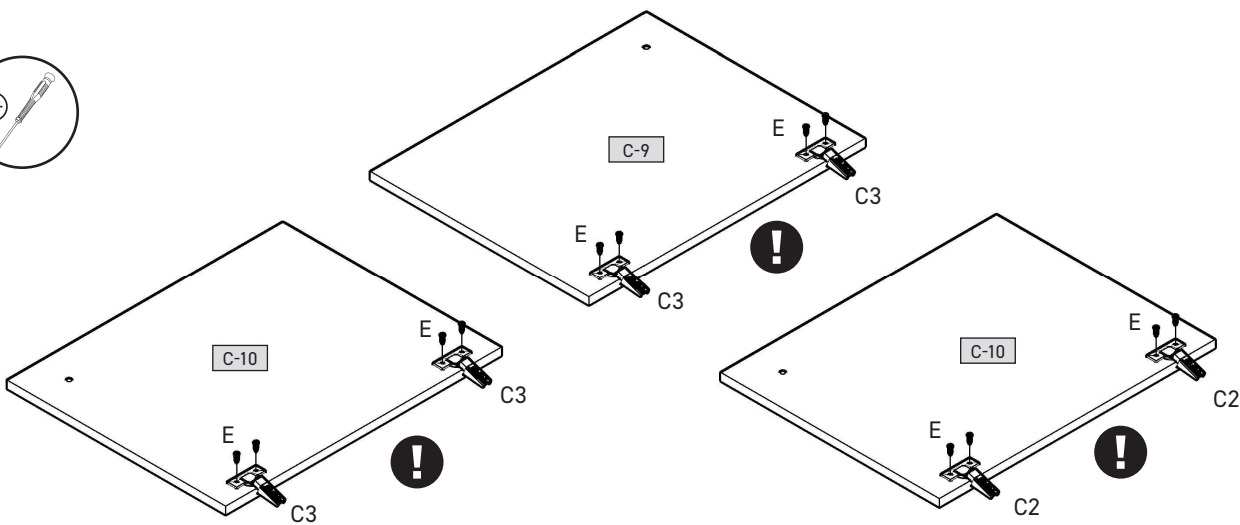

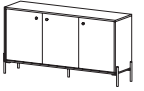

9



EM2 4x20mm x3	M x3	ZA ø4 x8	ZR ø15 x8
---------------------	---------	----------------	-----------------

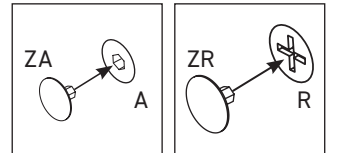
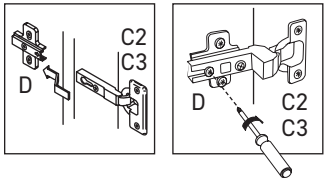
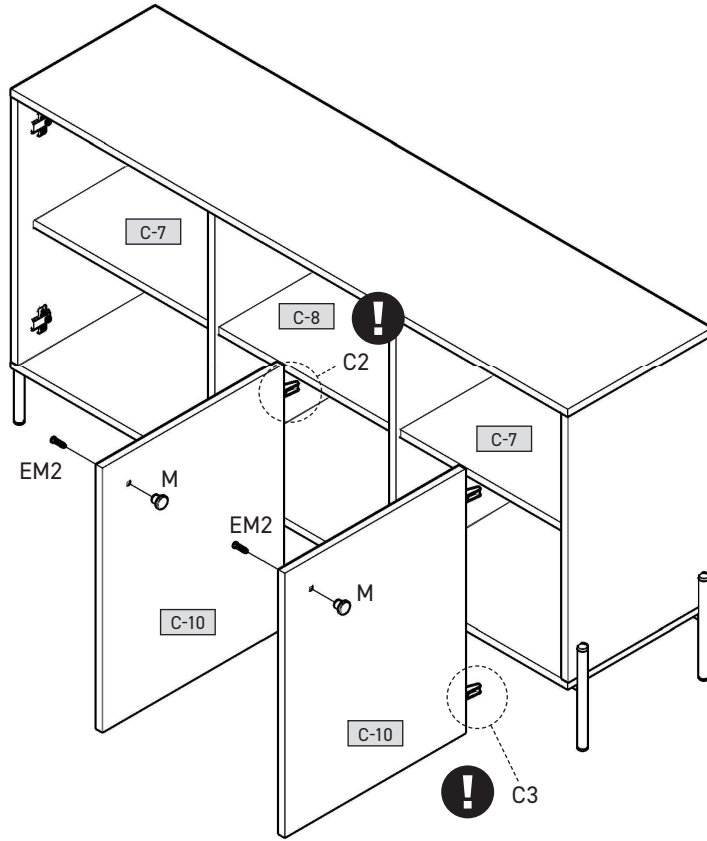
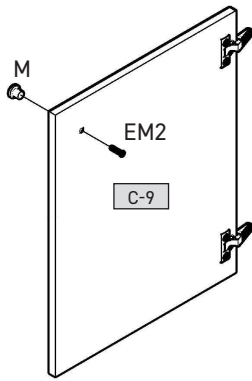

10

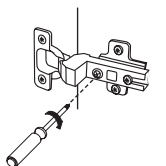
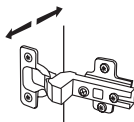
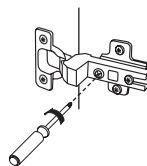
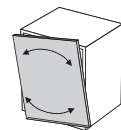
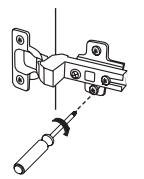
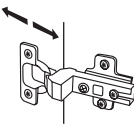
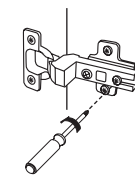
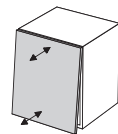
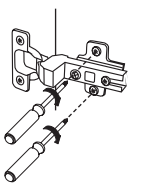
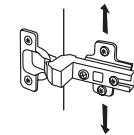
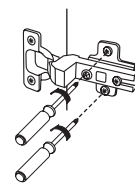
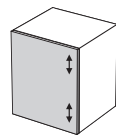
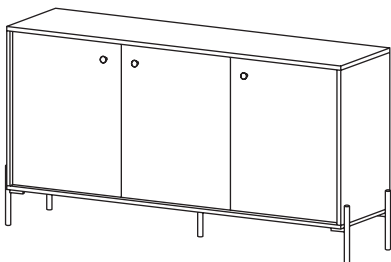

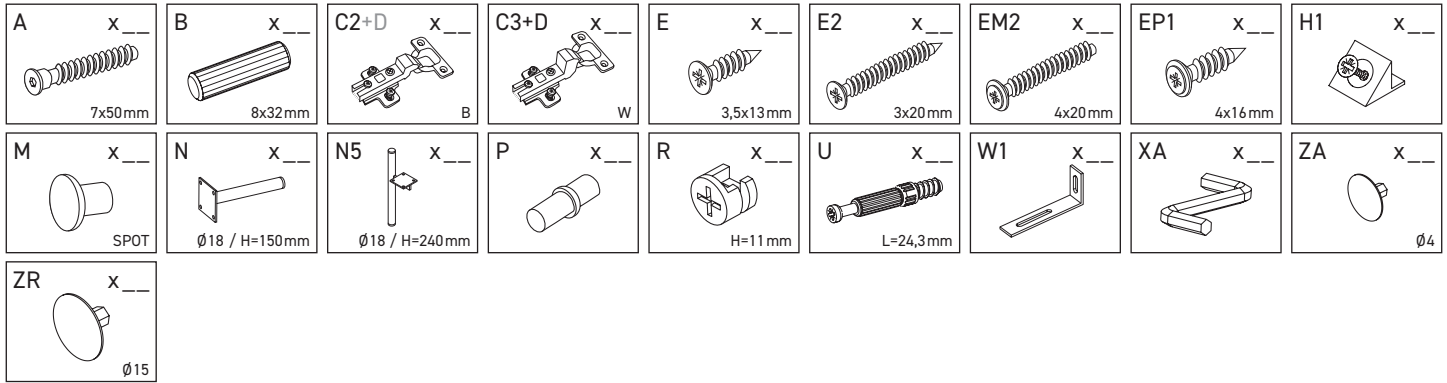

C-1	1531	395	16	x 1	1/3
C-2	1531	395	16	x 1	1/3
C-3	632	394	16	x 1	1/3
C-4	632	394	16	x 1	1/3
C-5	632	345	16	x 1	1/3
C-6	632	345	16	x 1	1/3
C-7	492	335	16	x 2	1/3
C-8	482	335	16	x 1	1/3
C-9	626	496	16	x 1	2/3
C-10	626	496	16	x 2	2/3
C-11	1512	646	3	x 1	1/3

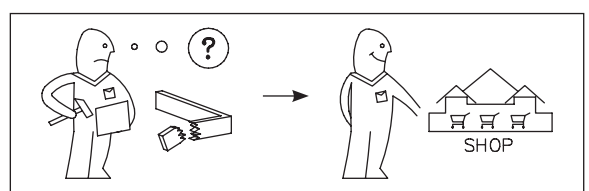
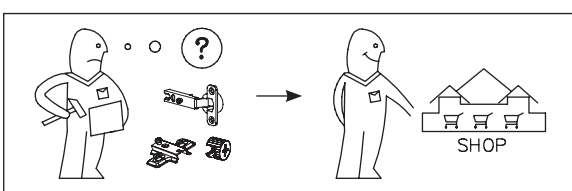
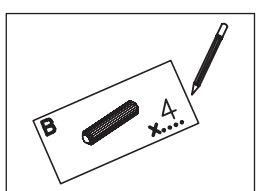
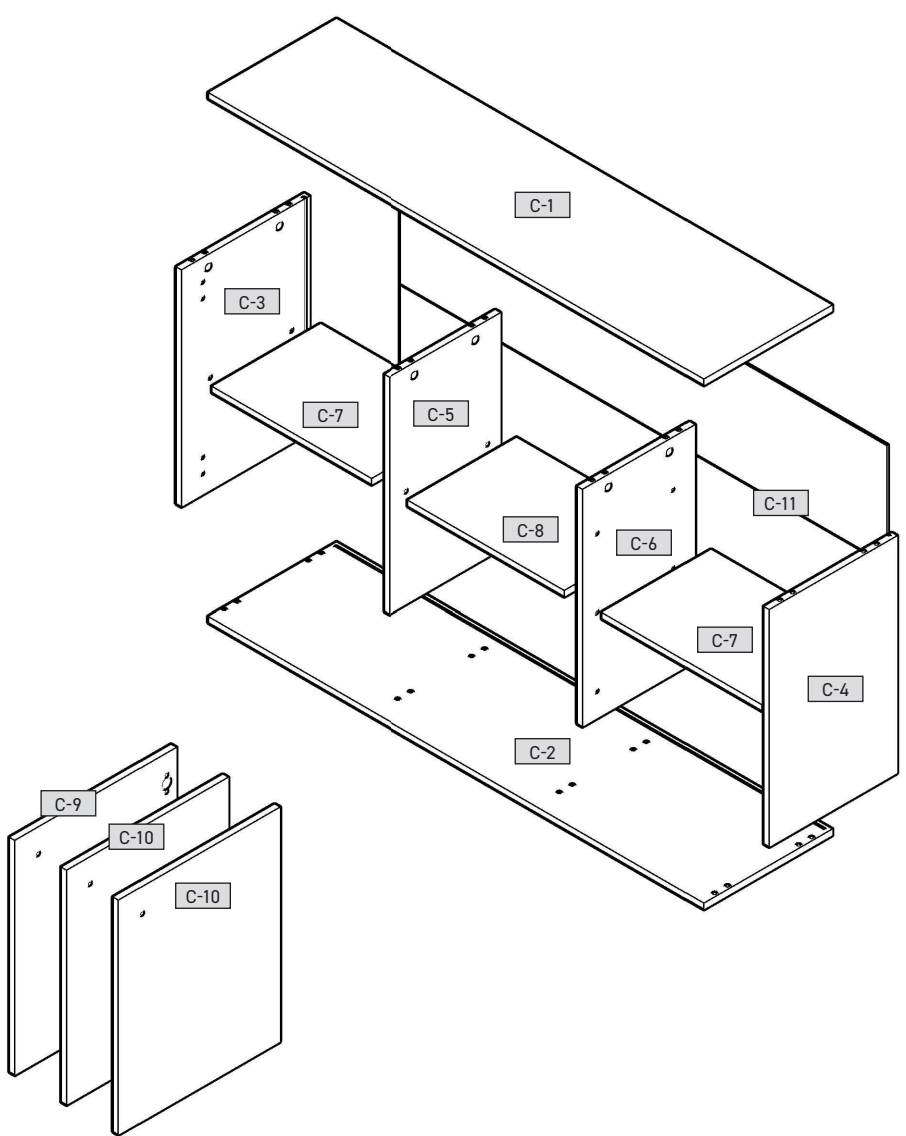
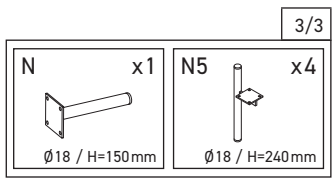

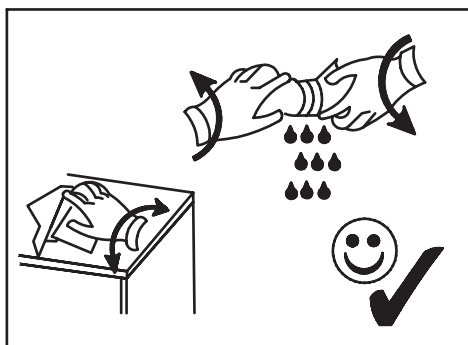
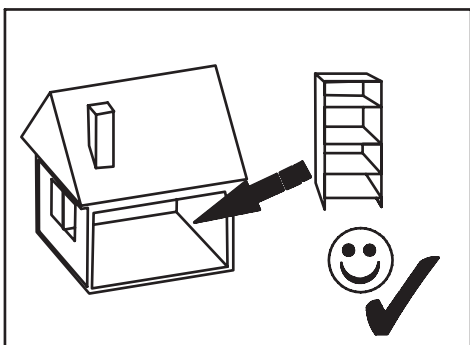
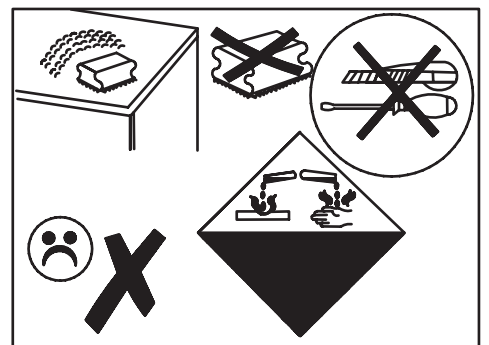
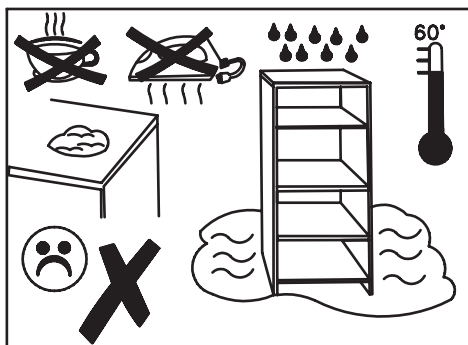
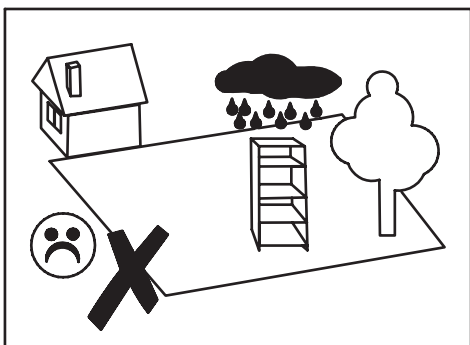
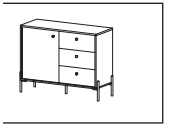

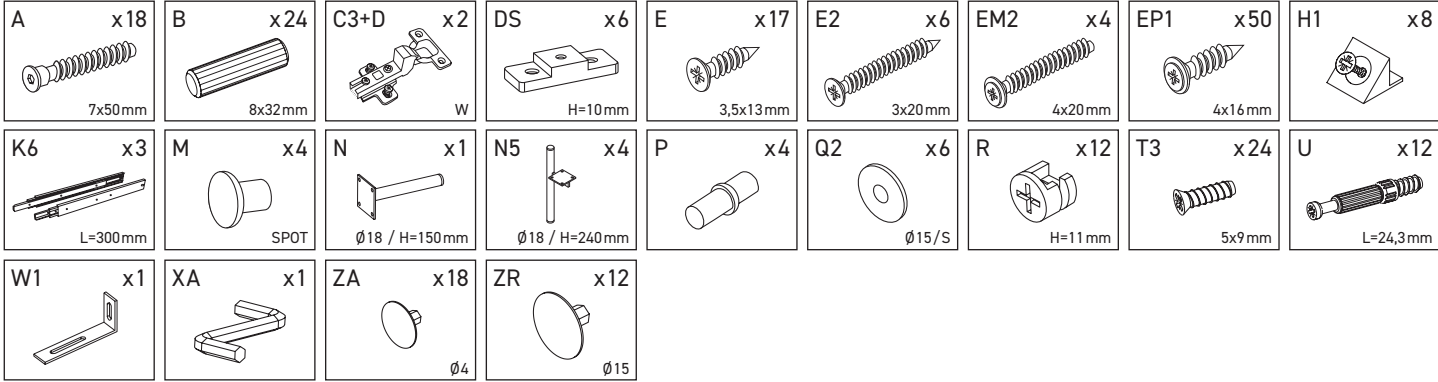
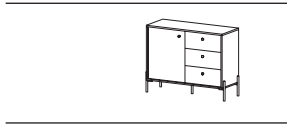

D-1	1033	395	16	x 1	1/2
D-2	1033	395	16	x 1	1/2
D-3	632	394	16	x 1	1/2
D-4	632	394	16	x 1	1/2
D-5	632	345	16	x 1	1/2
D-6	492	335	16	x 1	1/2
D-7	626	496	16	x 1	1/2
D-8	206	496	16	x 3	1/2
D-9	300	120	16	x 3	1/2
D-10	300	120	16	x 3	1/2
D-11	426	120	16	x 3	1/2
D-12	456	306	3	x 3	1/2
D-13	507	646	3	x 1	1/2
D-14	507	646	3	x 1	1/2

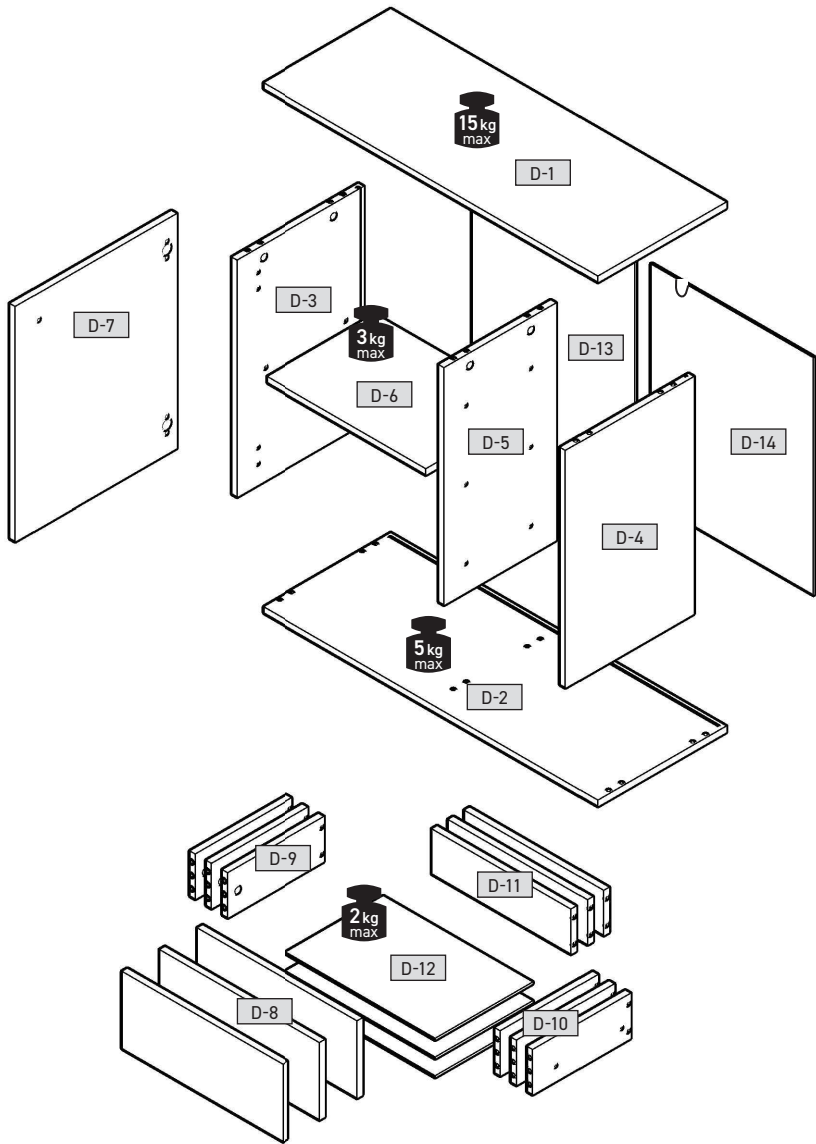

2/2

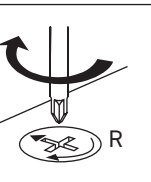
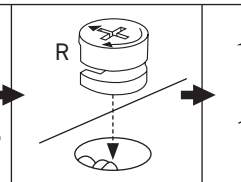
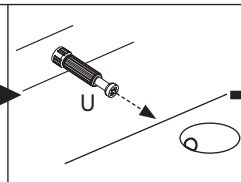
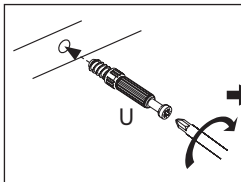
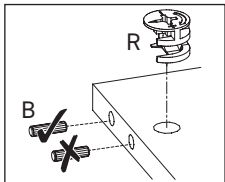
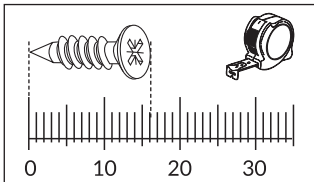
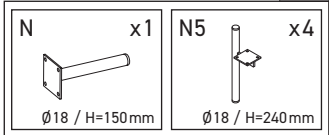



1



B x12 8x32mm	C3+D x2 W	DS x6 H=10mm	E x12 3,5x13mm	U x6 L=24,3mm
------------------------	---------------------	------------------------	--------------------------	-------------------------

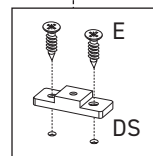
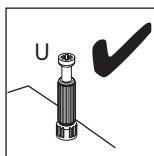
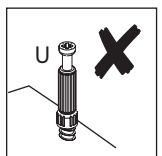
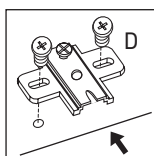
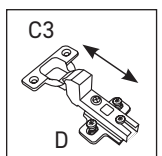
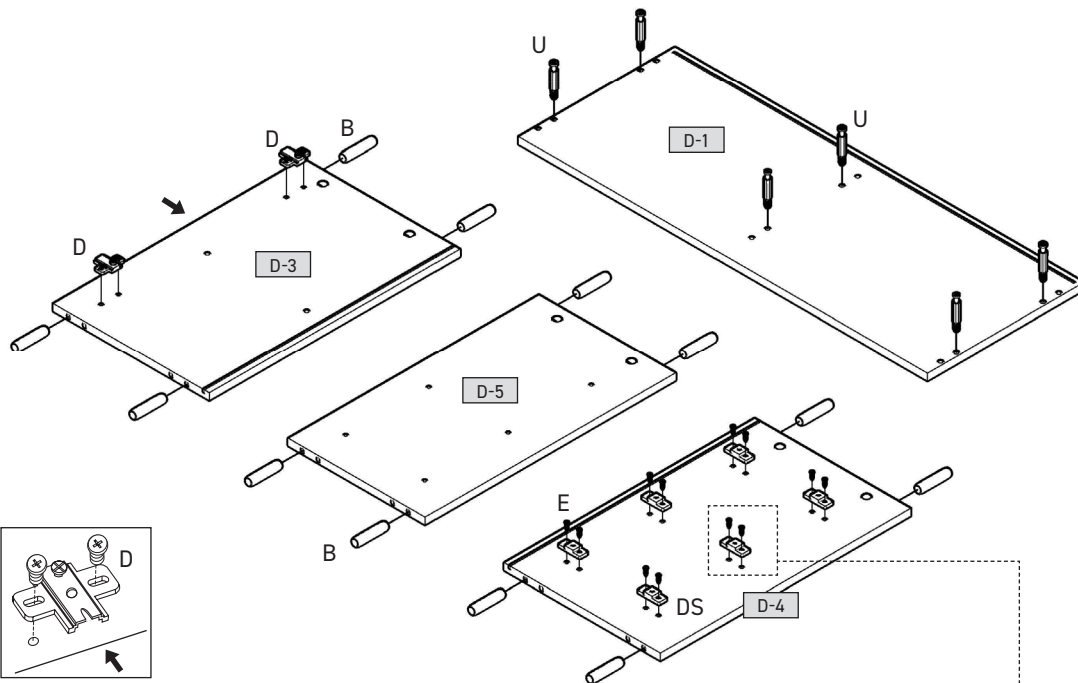

2



K6 x3 L=300mm	T3 x12 5x9mm
-------------------------	------------------------

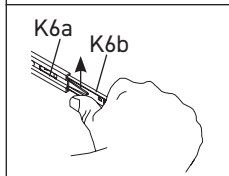
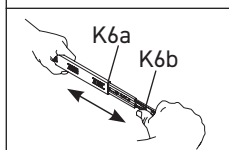
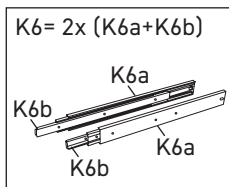
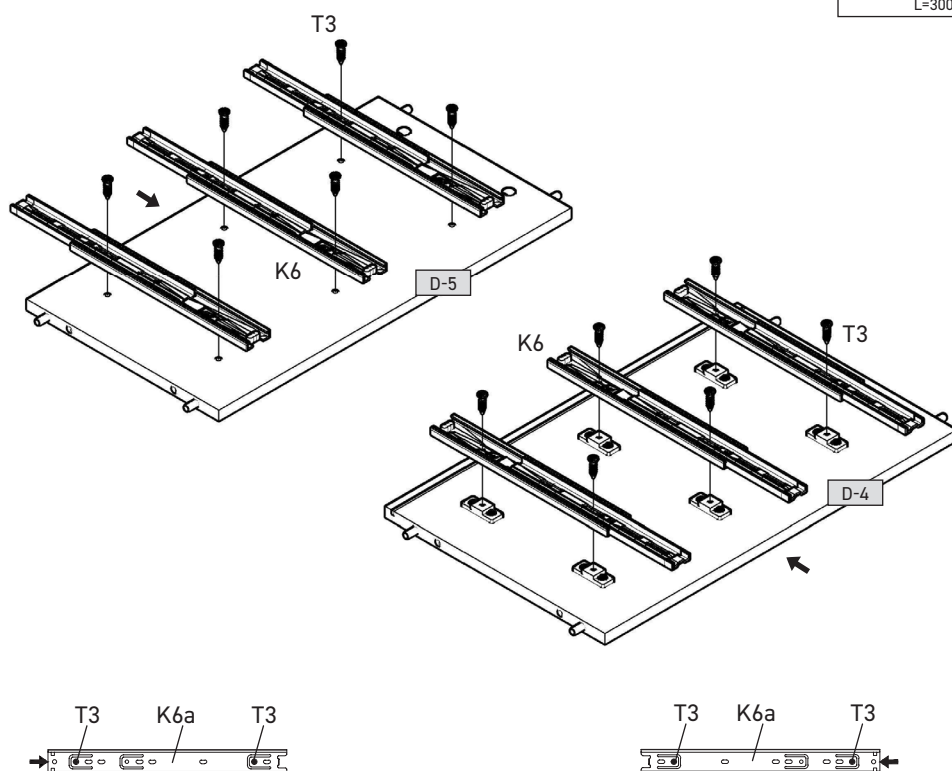

3

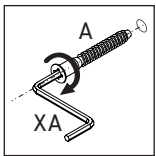
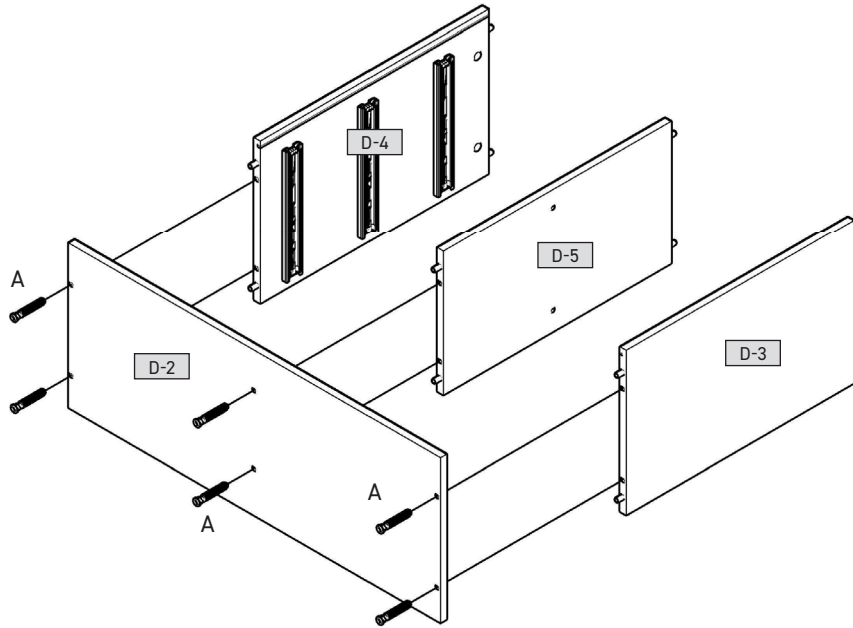
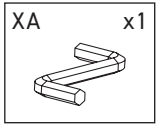
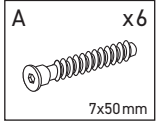
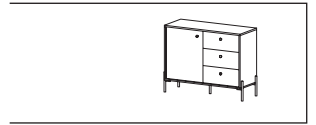

4

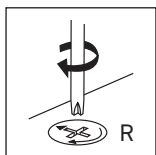
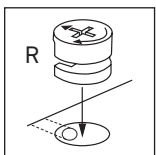
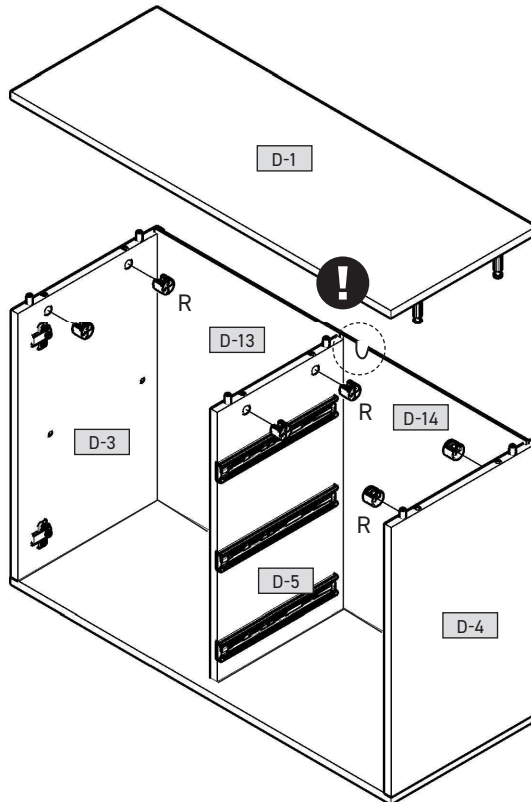
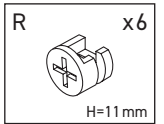



5

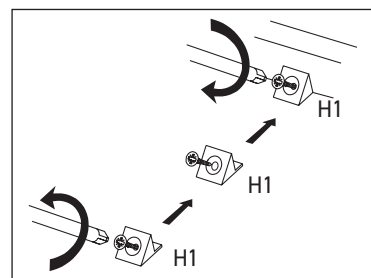
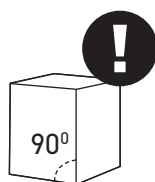
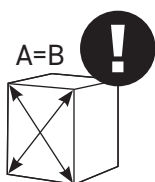
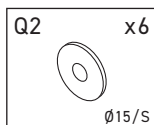
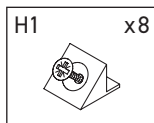
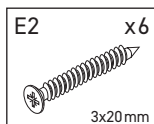
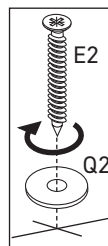
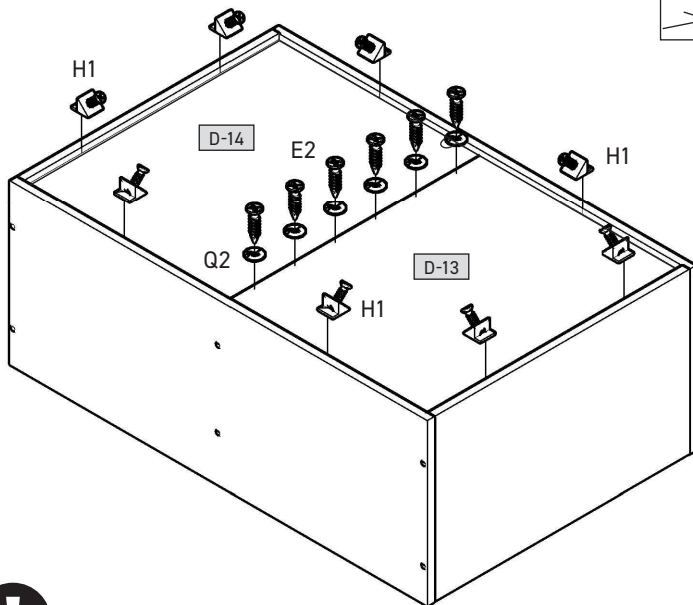
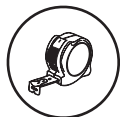

6

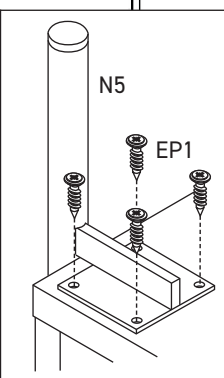
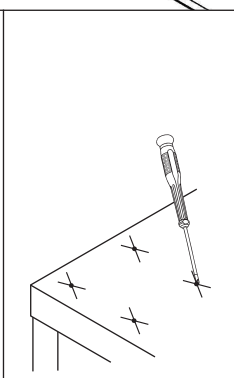
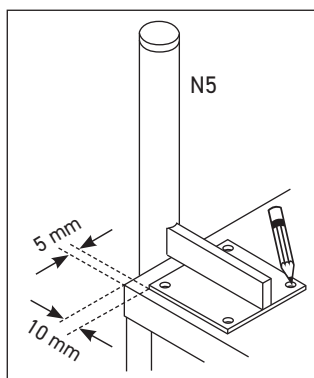
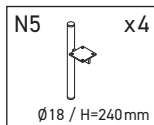
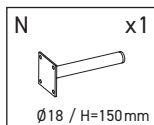
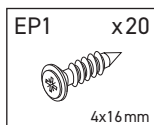
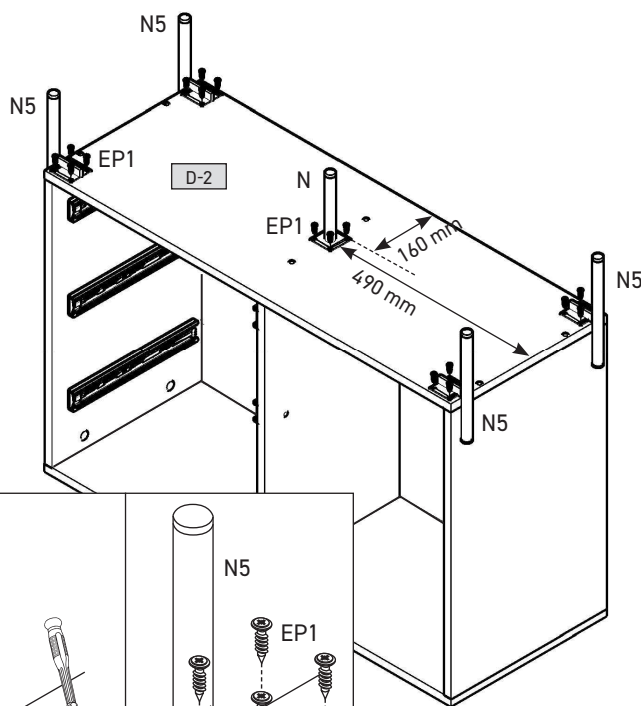



7

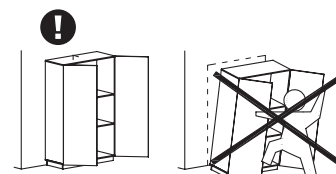
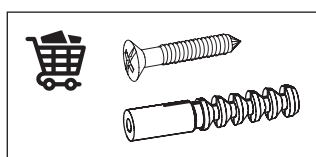
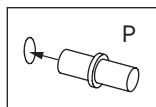
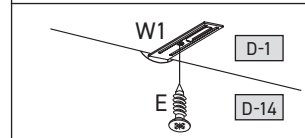
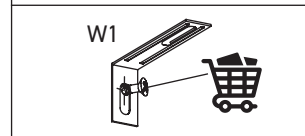
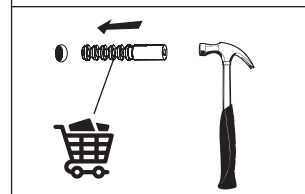
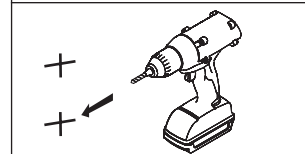
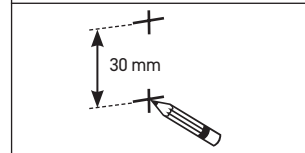
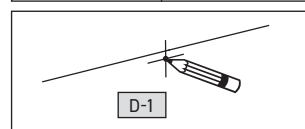
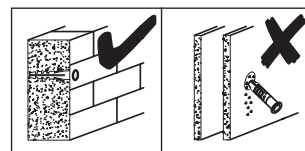
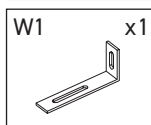
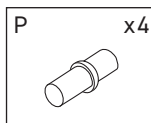
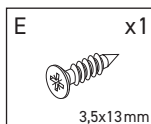
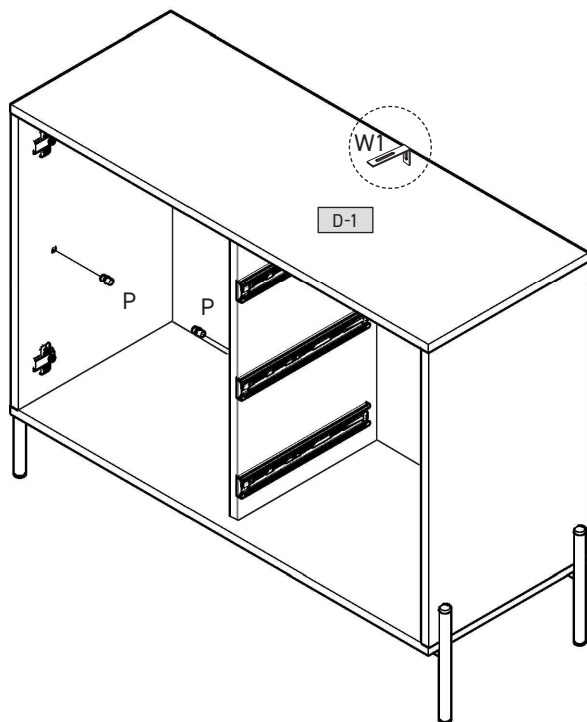
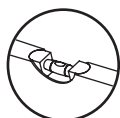
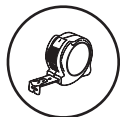

8

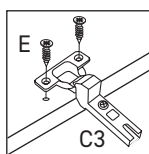
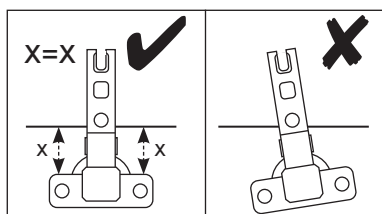
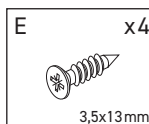
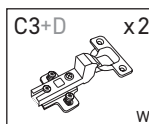
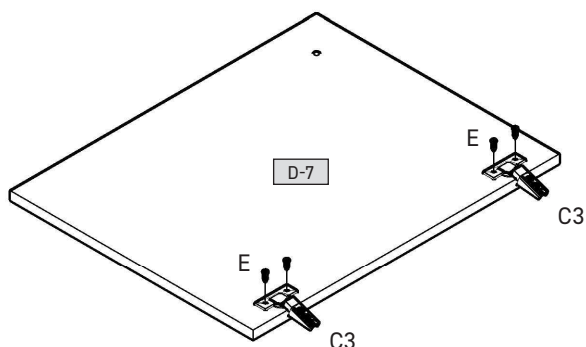



9

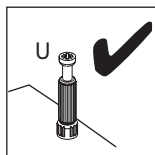
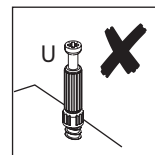
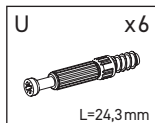
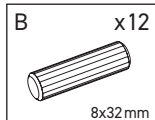
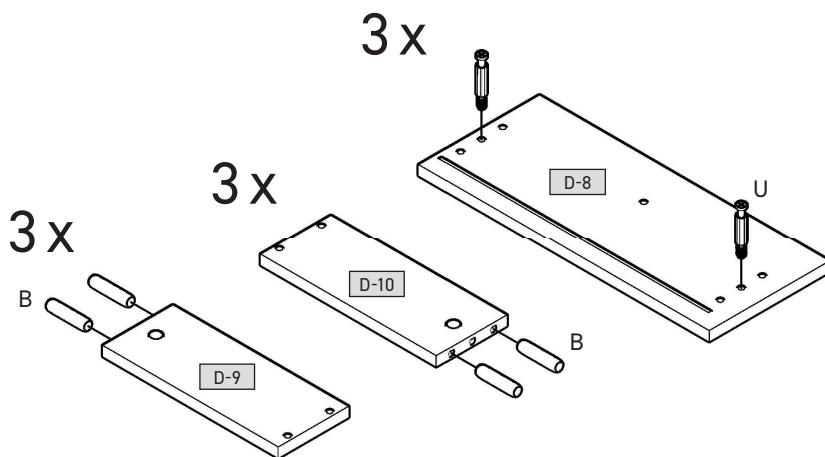

10

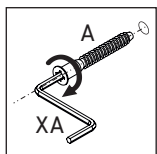
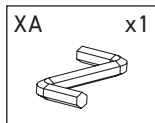
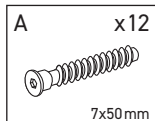
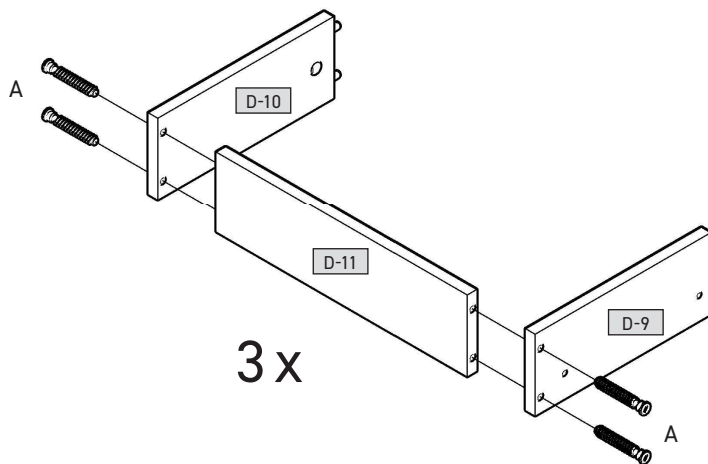

11

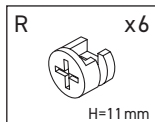
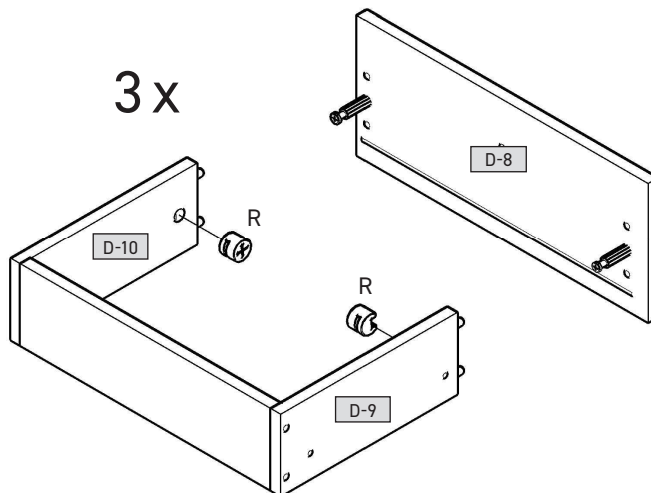
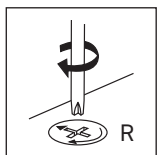
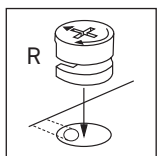



12

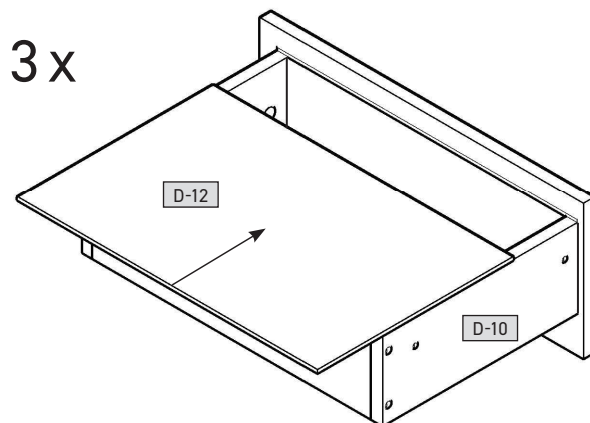

13

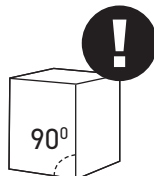
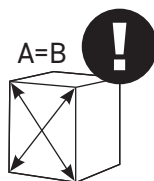
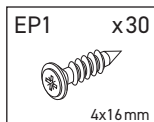
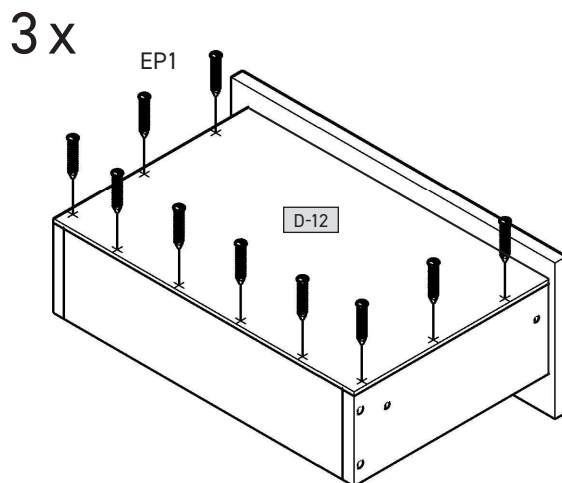
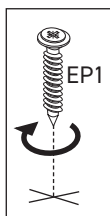

14

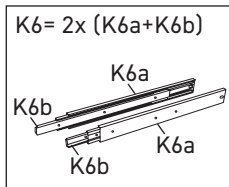
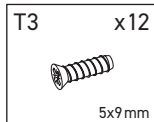
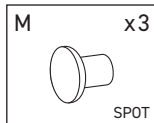
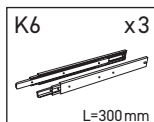
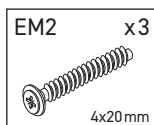
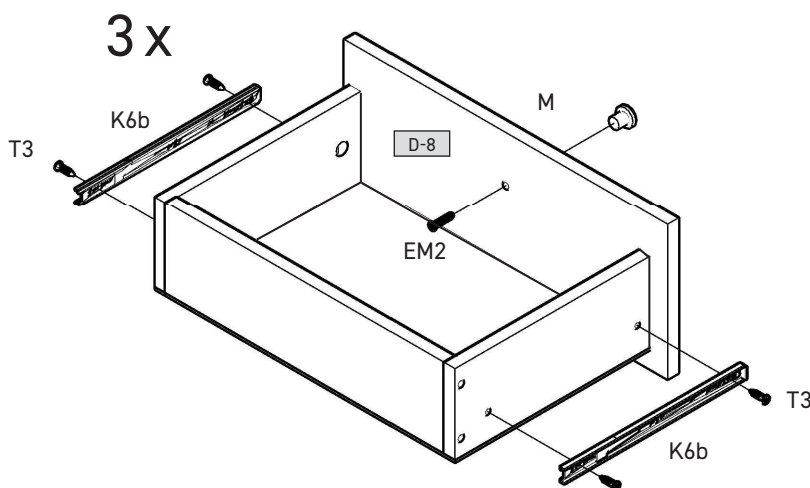



15

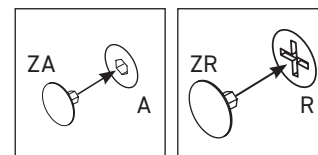
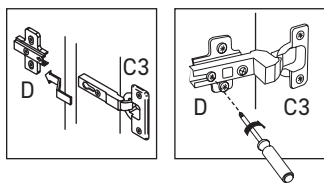
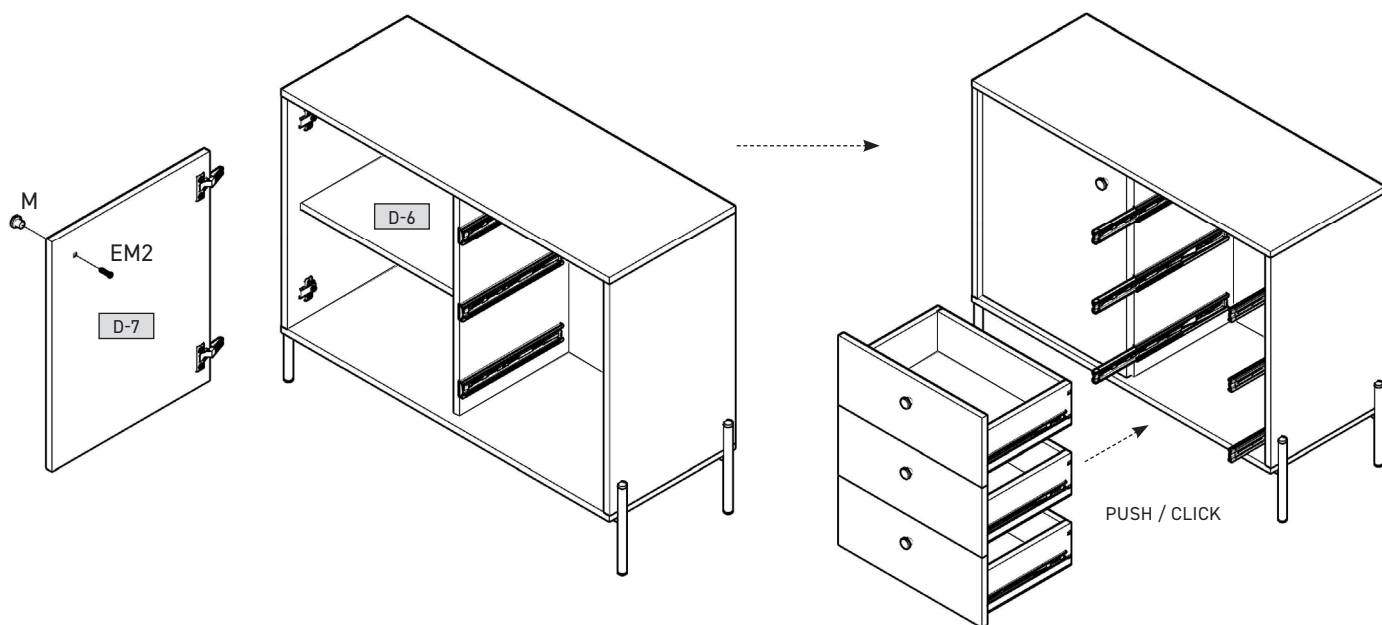
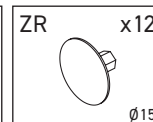
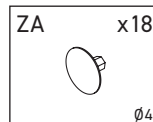
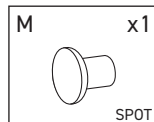
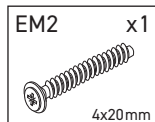

16

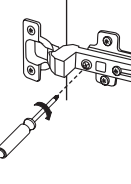
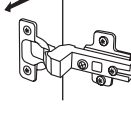
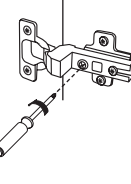
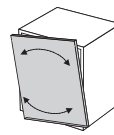
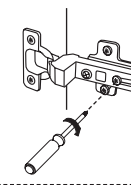
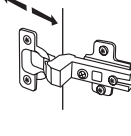
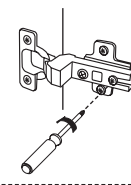
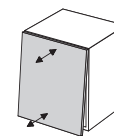
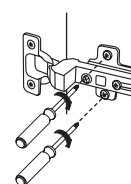
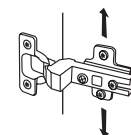
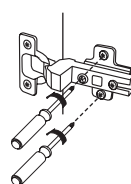
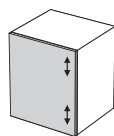
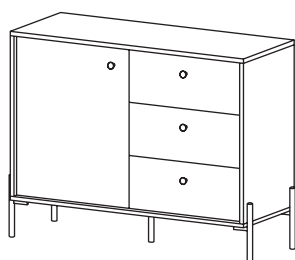

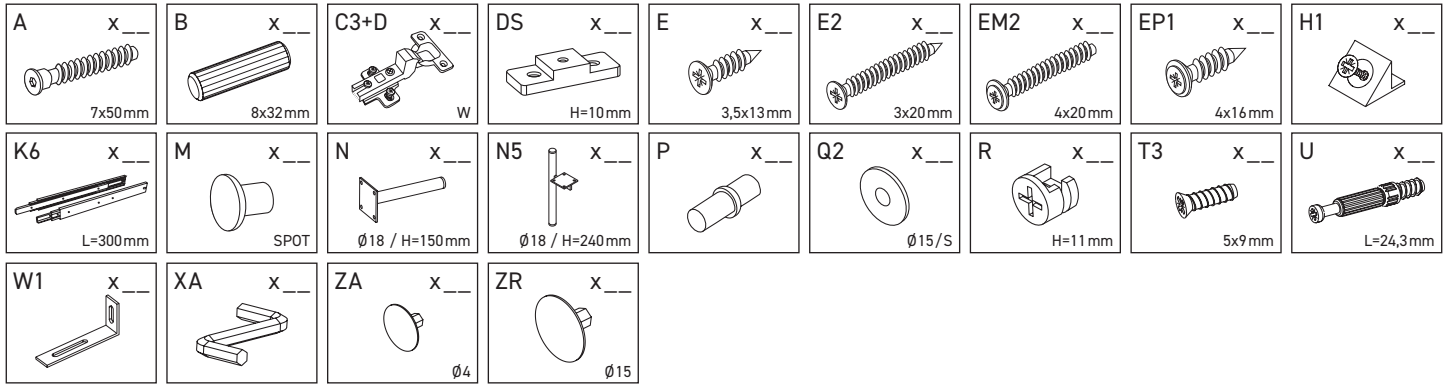

D-1	1033	395	16	x 1	1/2
D-2	1033	395	16	x 1	1/2
D-3	632	394	16	x 1	1/2
D-4	632	394	16	x 1	1/2
D-5	632	345	16	x 1	1/2
D-6	492	335	16	x 1	1/2
D-7	626	496	16	x 1	1/2
D-8	206	496	16	x 3	1/2
D-9	300	120	16	x 3	1/2
D-10	300	120	16	x 3	1/2
D-11	426	120	16	x 3	1/2
D-12	456	306	3	x 3	1/2
D-13	507	646	3	x 1	1/2
D-14	507	646	3	x 1	1/2

