

C-1	1531	395	16	x 1	1/3
C-2	1531	395	16	x 1	1/3
C-3	632	394	16	x 1	1/3
C-4	632	394	16	x 1	1/3
C-5	632	345	16	x 1	1/3
C-6	632	345	16	x 1	1/3
C-7	492	335	16	x 2	1/3
C-8	482	335	16	x 1	1/3
C-9	626	496	16	x 1	2/3
C-10	626	496	16	x 2	2/3
C-11	1512	646	3	x 1	1/3

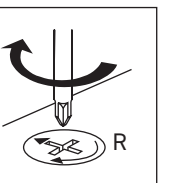

1

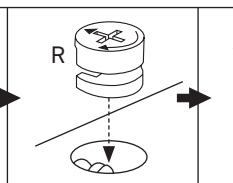
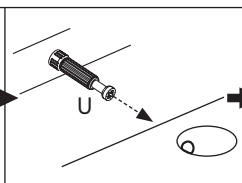
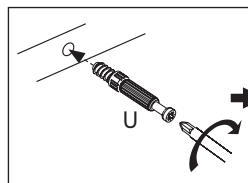
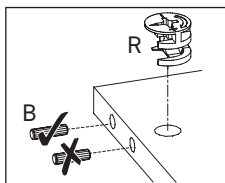
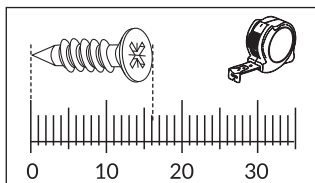
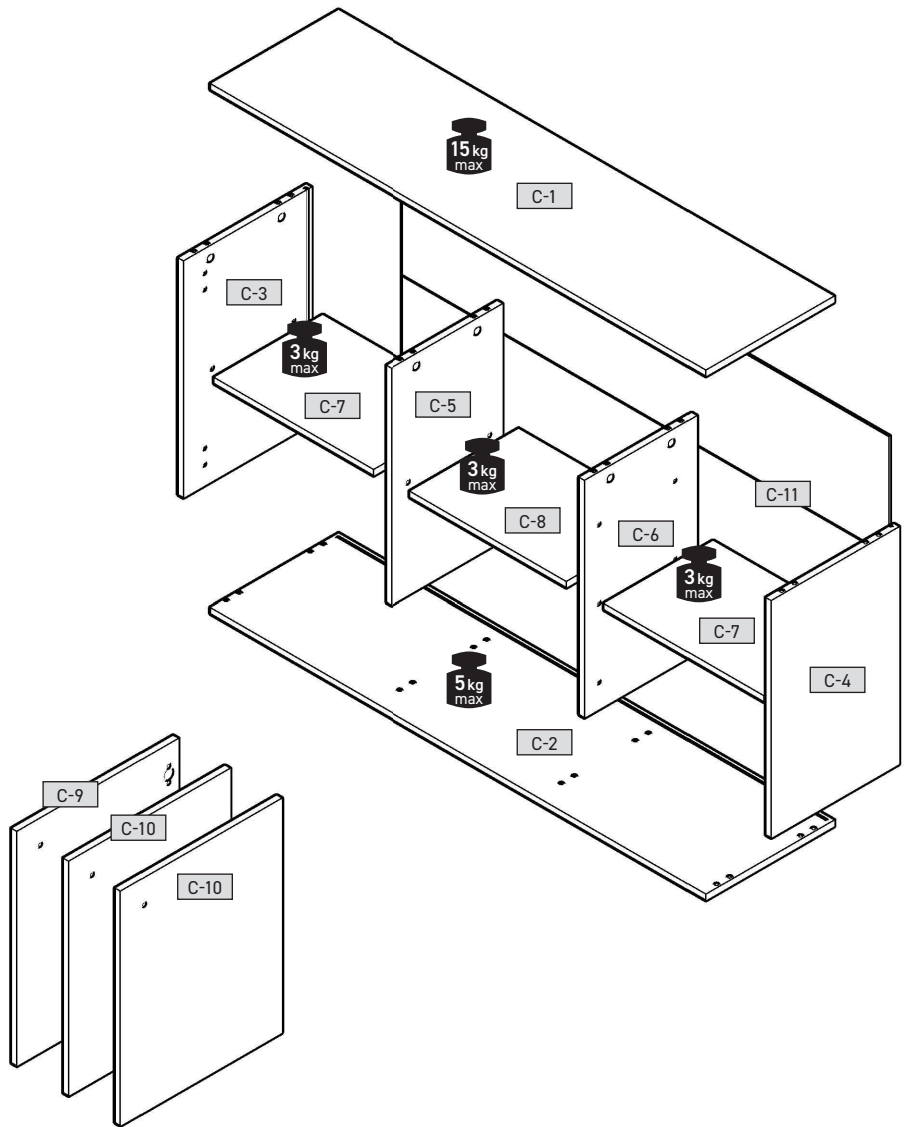
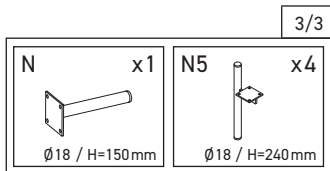
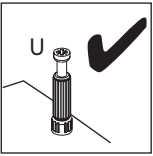
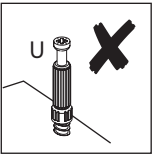
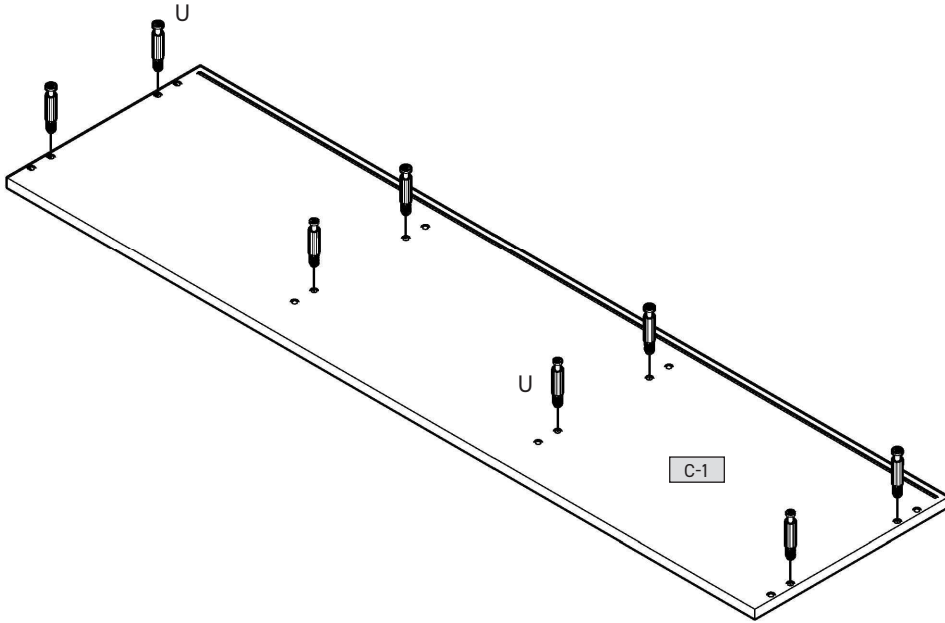
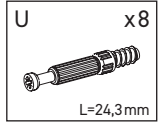

2

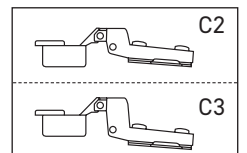
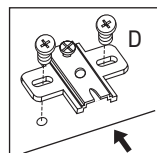
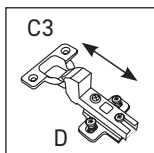
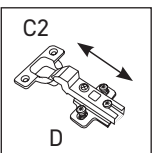
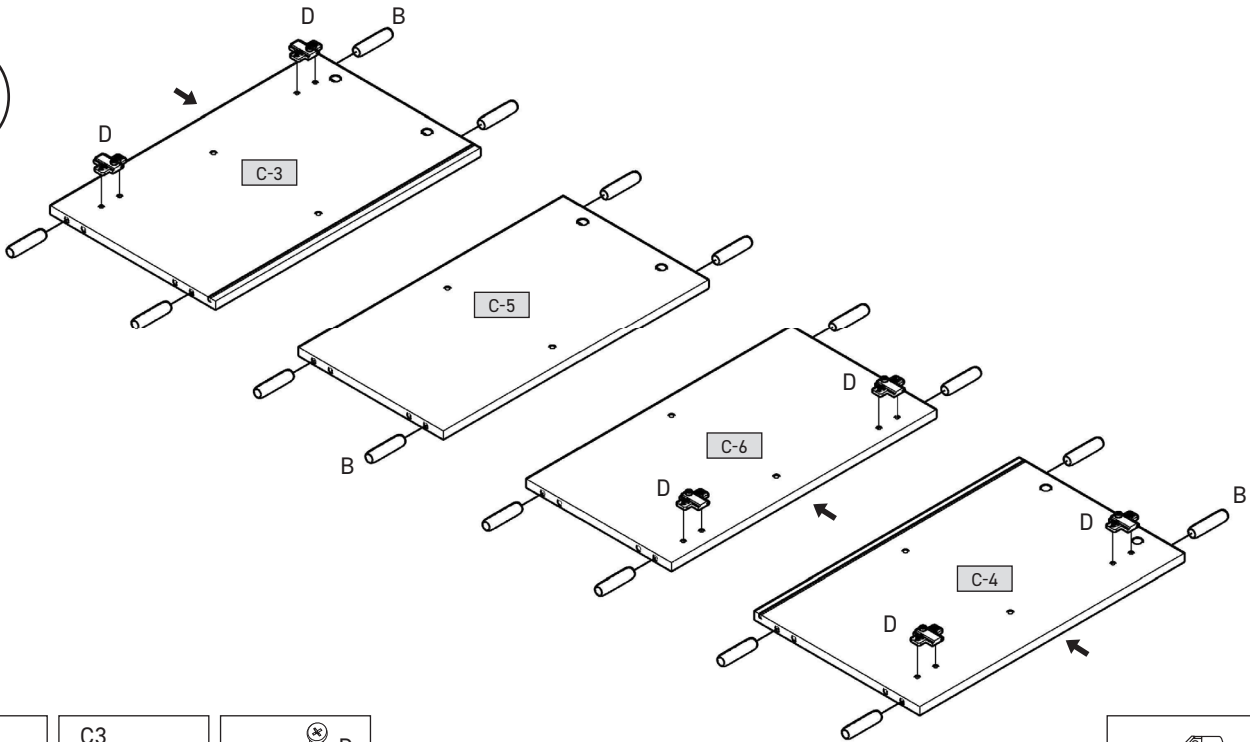
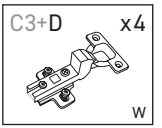
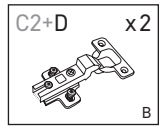
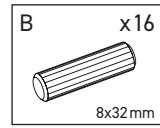

3

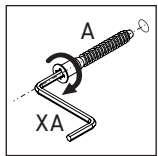
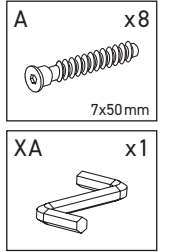
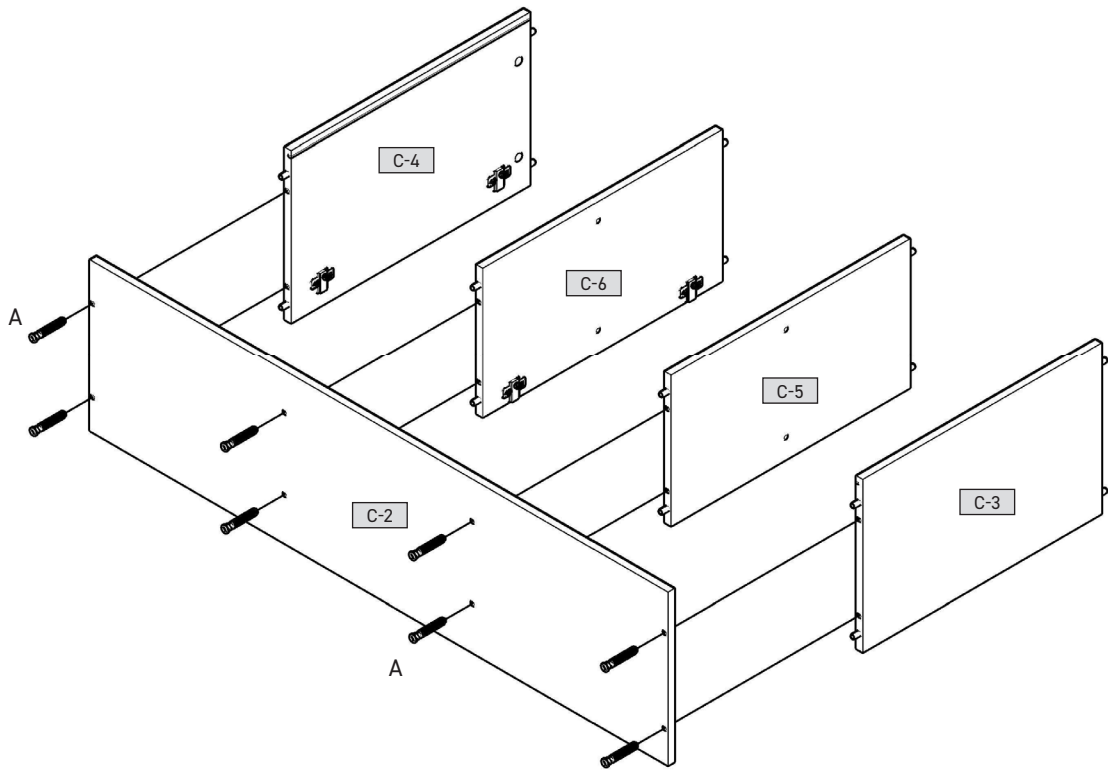

4

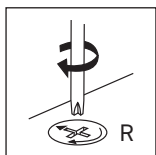
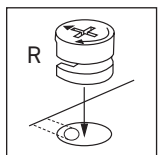
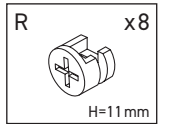
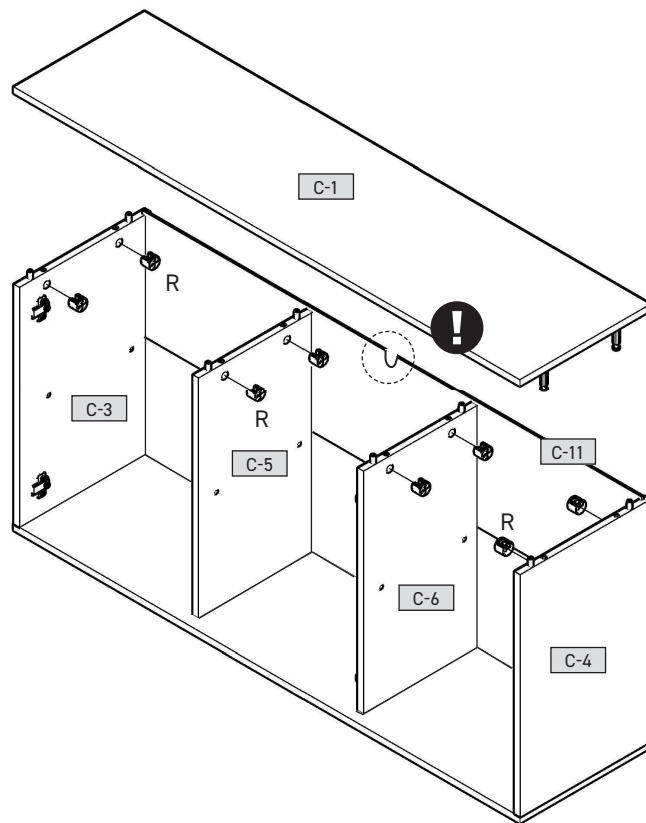

5

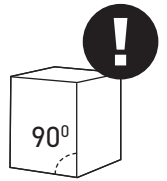
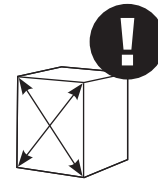
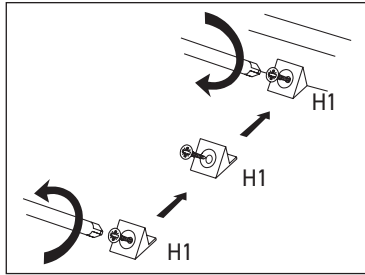
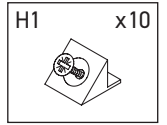
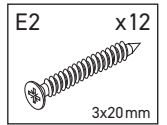
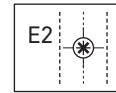
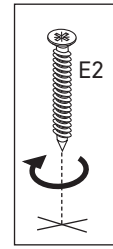
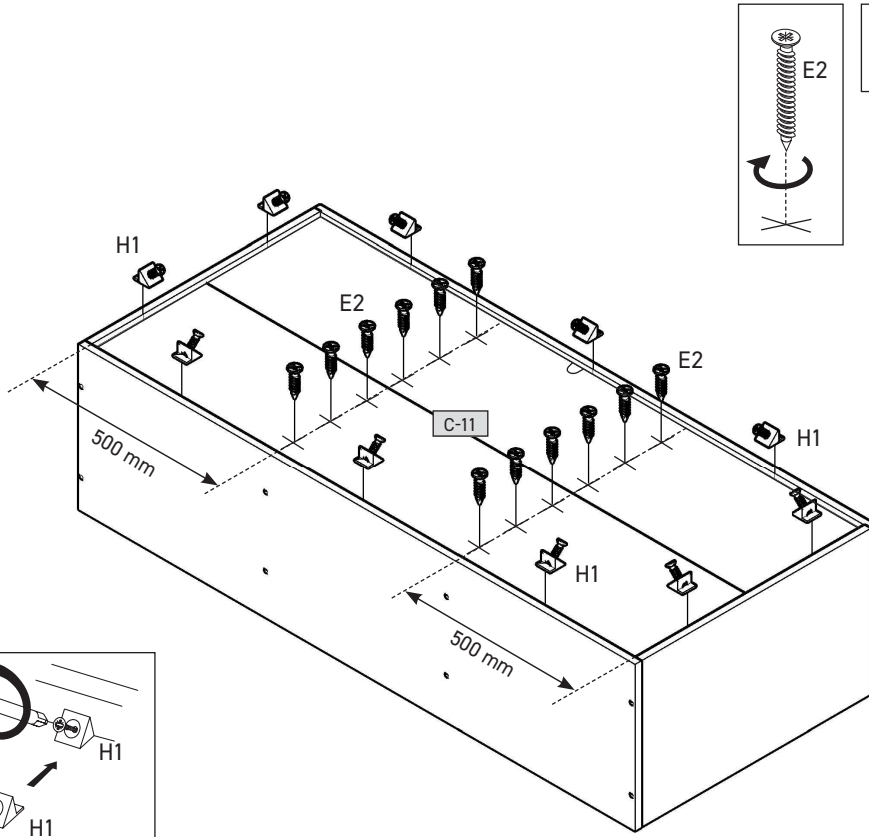

6

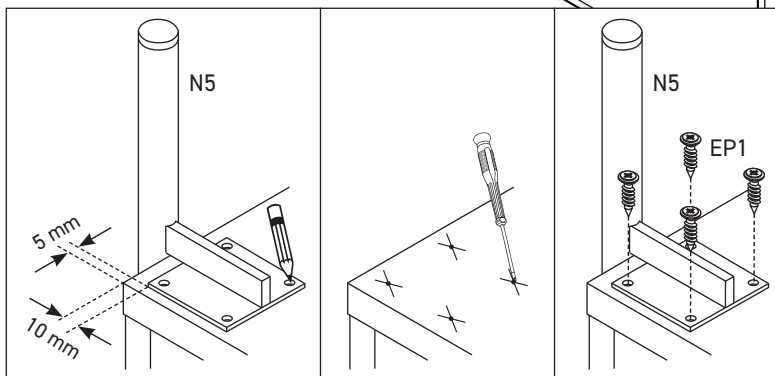
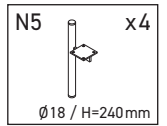
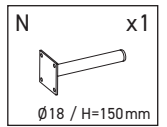
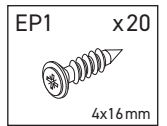
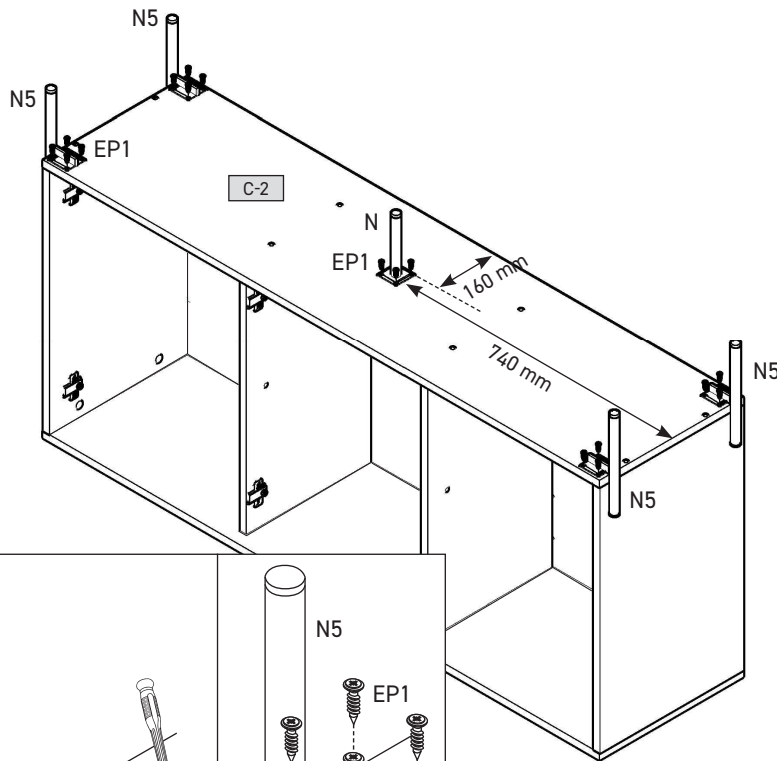

7

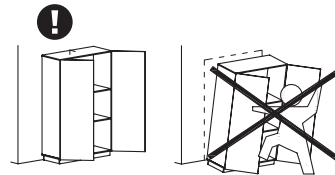
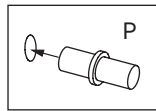
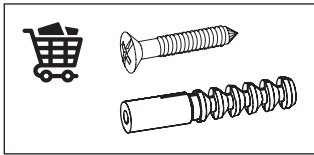
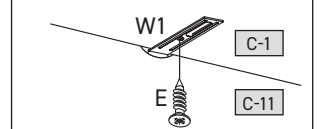
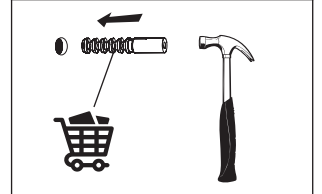
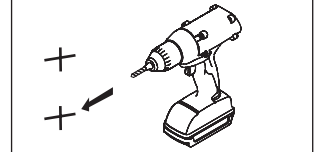
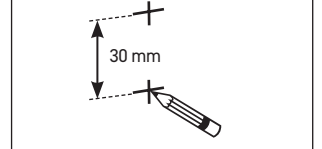
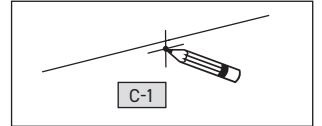
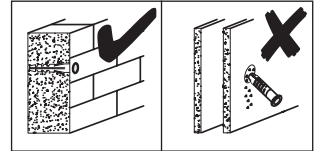
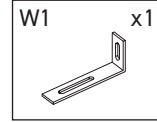
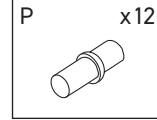
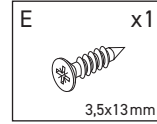
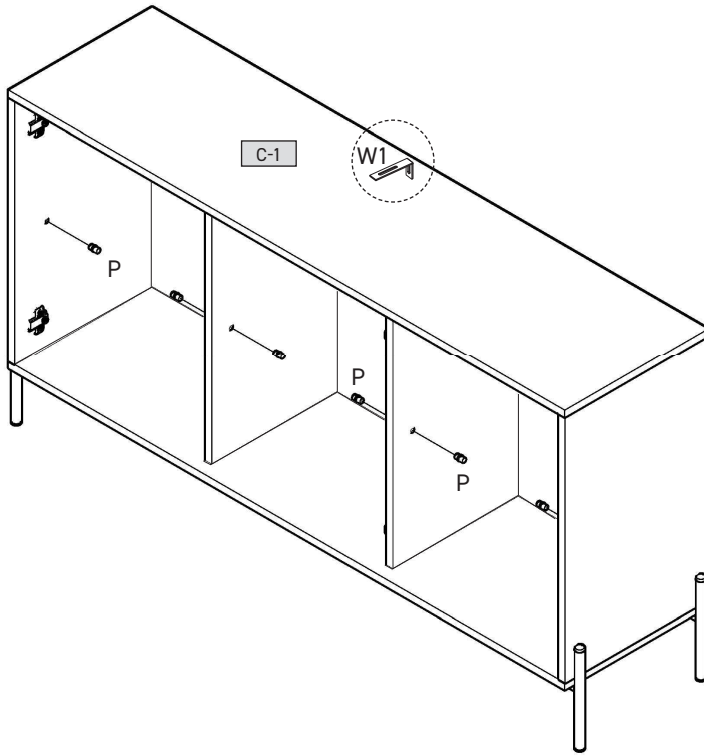

8

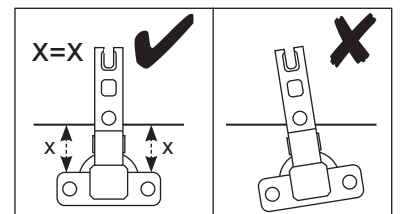
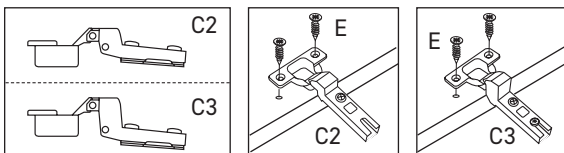
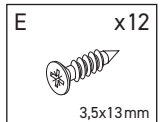
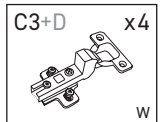
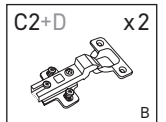
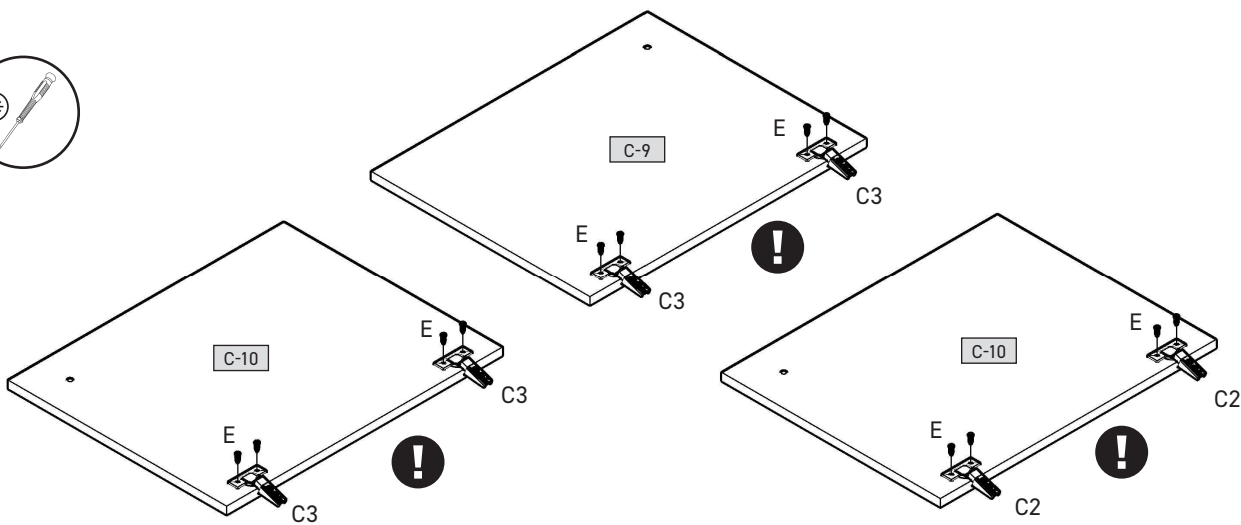

9

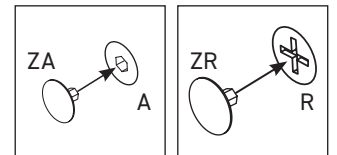
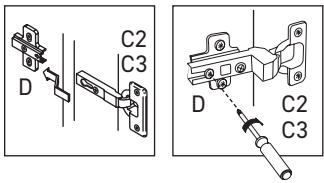
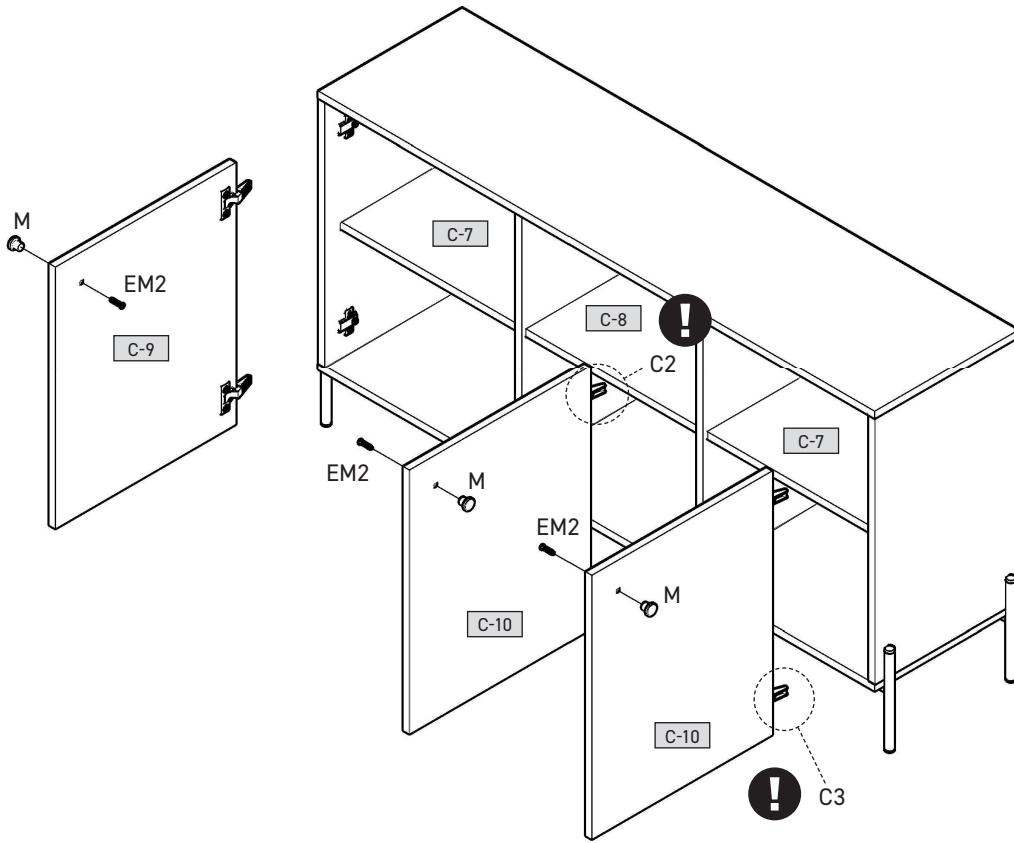
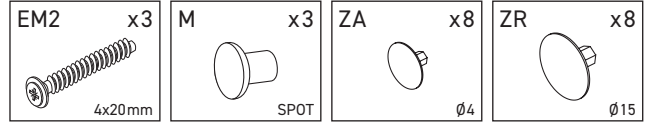

10

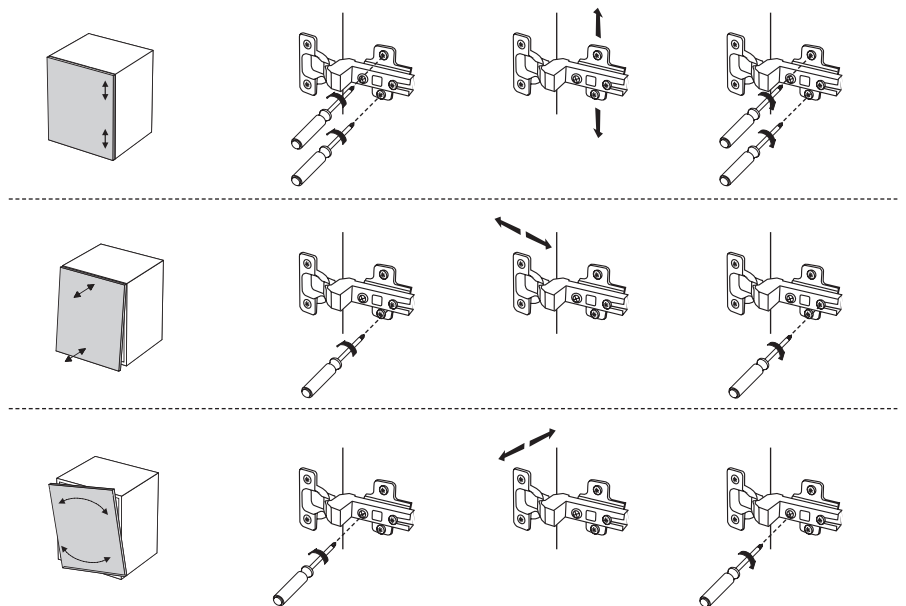
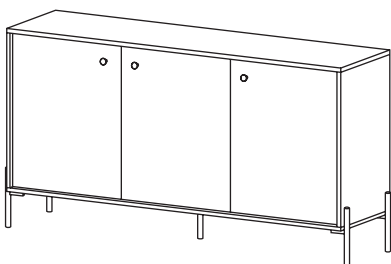



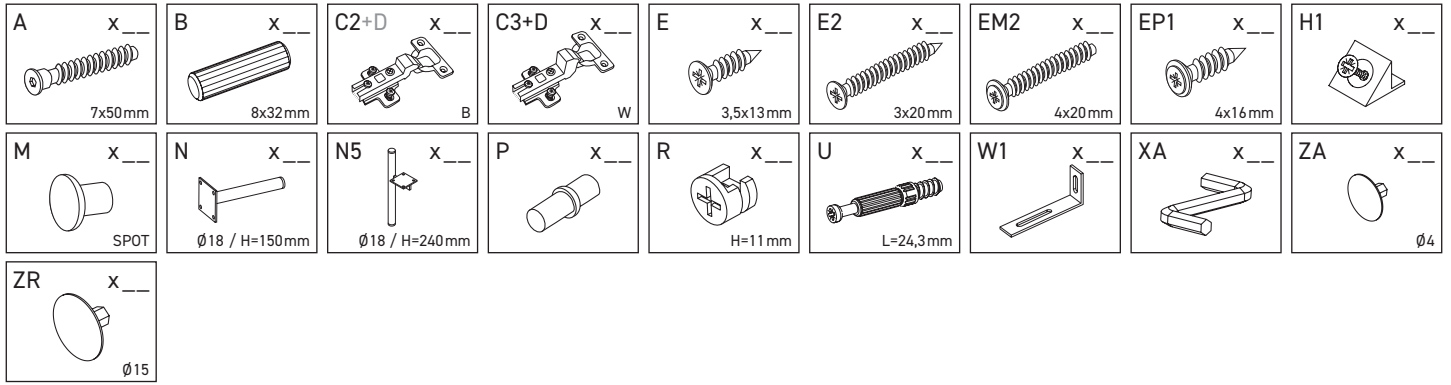

C-1	1531	395	16	x 1	1/3
C-2	1531	395	16	x 1	1/3
C-3	632	394	16	x 1	1/3
C-4	632	394	16	x 1	1/3
C-5	632	345	16	x 1	1/3
C-6	632	345	16	x 1	1/3
C-7	492	335	16	x 2	1/3
C-8	482	335	16	x 1	1/3
C-9	626	496	16	x 1	2/3
C-10	626	496	16	x 2	2/3
C-11	1512	646	3	x 1	1/3

