

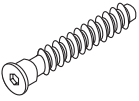

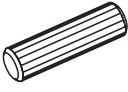

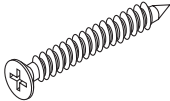

A  7 x 50 mm x 6	B  8 x 32 mm x 48	E2  3 x 20 mm x 50	E5  4 x 16 mm x 32	EE2  x 10	EM3  6 x 35 mm x 6
G2  x 11	O1  x 10	QB  x 10	R  H=11 mm x 26	R1  H=15 mm x 4	RRa  H=16 mm x 4
RRb  6 x 55 x 8	RRc  H=13 mm x 4	U  L=24,3 mm x 30	W9  x 4	Xa  4 mm x 1	Xb  6 mm x 1

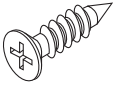

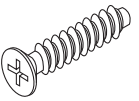

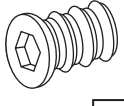
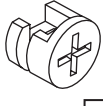
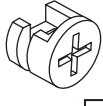
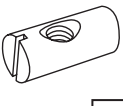
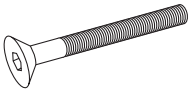
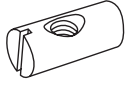
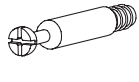
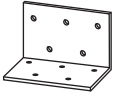
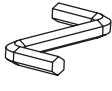
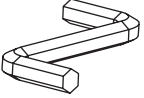
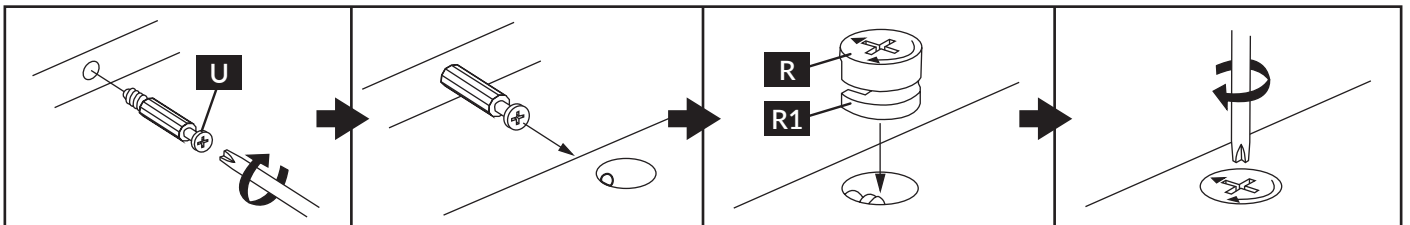
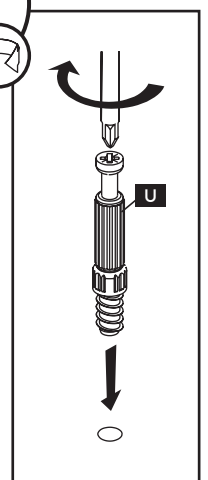
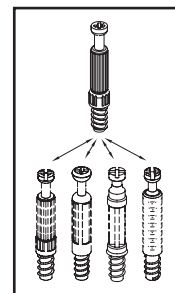
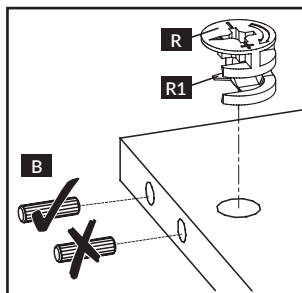
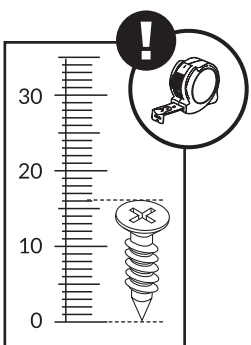
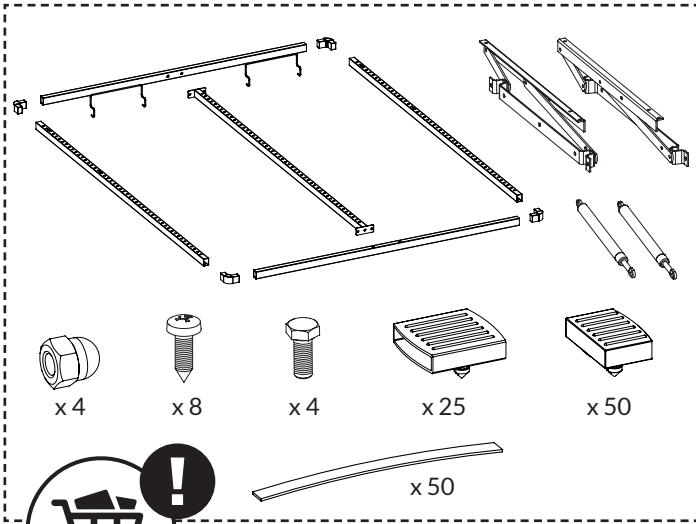
nr	↔ [mm]	↓ [mm]	∇ [mm]	Menge	Colli
N-1	1645	1000	16	x 1	2/2
N-2	1360	320	25	x 1	1/2
N-3	1645	60	16	x 1	1/2
N-4	1000	44	16	x 4	2/2
N-5	1645	272	22	x 1	2/2
N-6	2022	270	22	x 1	1/2
N-7	2022	270	22	x 1	1/2
N-8	1600	250	16	x 1	1/2
N-9	1600	250	16	x 1	1/2
N-10	1600	80	16	x 1	1/2
N-11	1301	250	16	x 1	2/2
N-12	1268	250	16	x 1	2/2
N-13	1850	250	16	x 1	1/2
N-14	1850	250	16	x 1	1/2
N-15	1296	1002	3	x 1	2/2

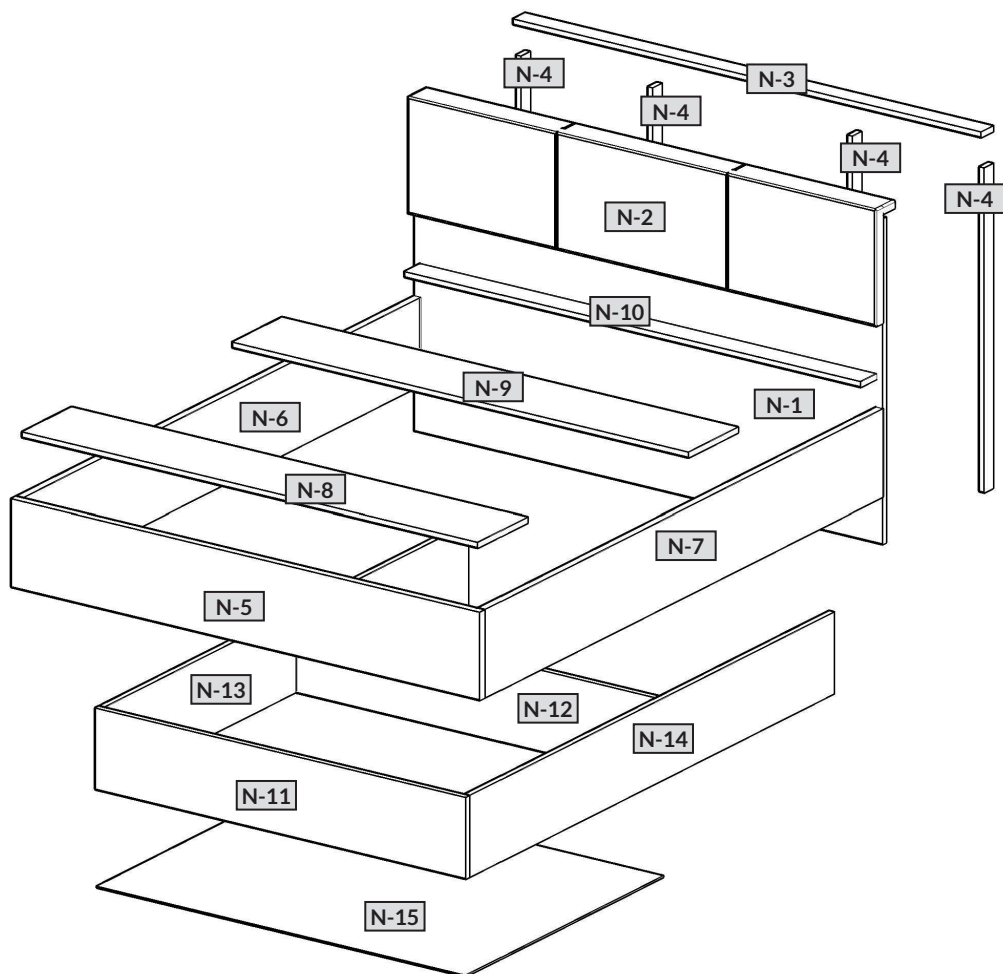



1

B 8 x 32 mm x 12

R H=11 mm x 6

U L=24.3 mm x 6

N-5, **N-9**, **N-8**

B, **R**, **U**

2

B 8 x 32 mm x 8

E5 4 x 16 mm x 16

R1 H=15 mm x 4

RRA H=16 mm x 4

U L=24.3 mm x 4

W9 x 4

N-6, **N-7**

B, **E5**, **R1**, **RRA**, **U**, **W9**



3

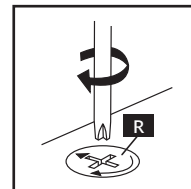
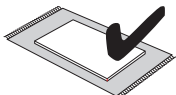
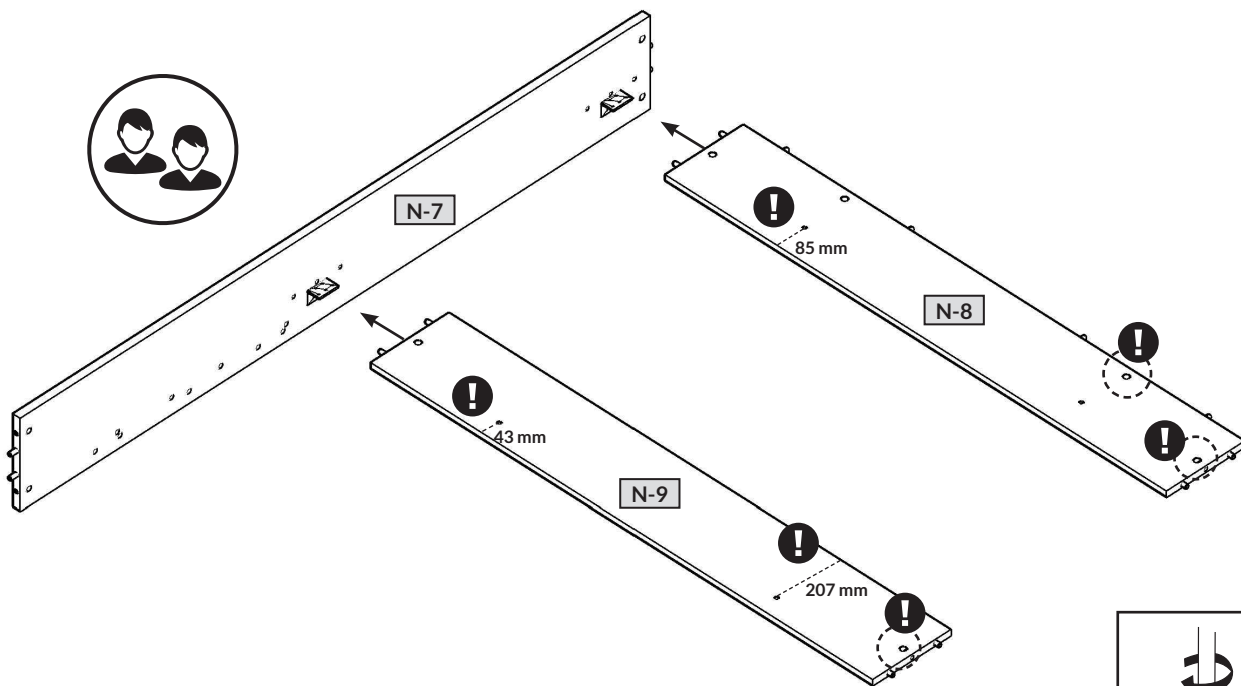

4

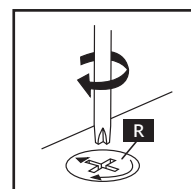
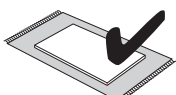
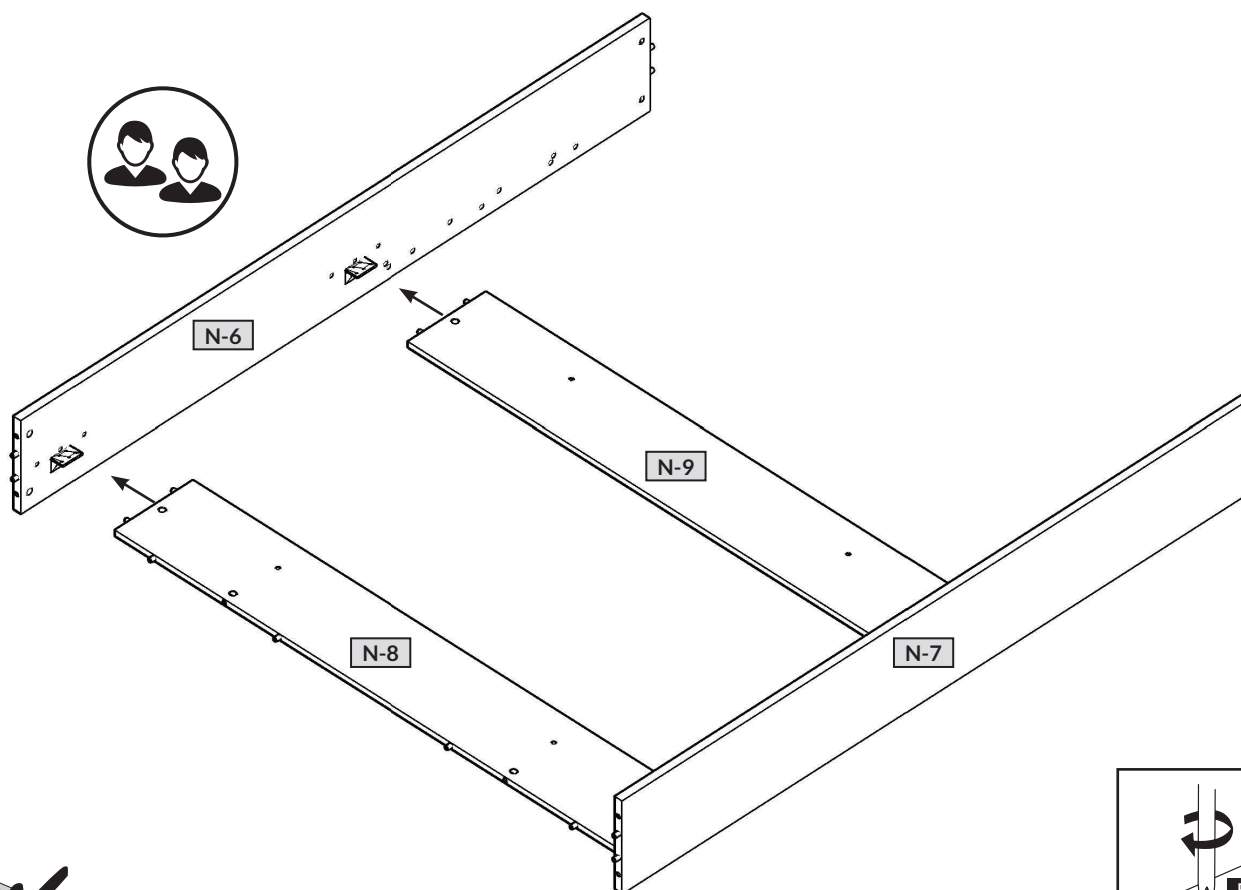



5

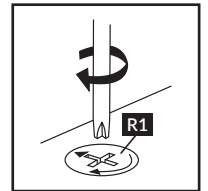
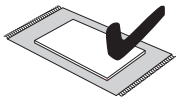
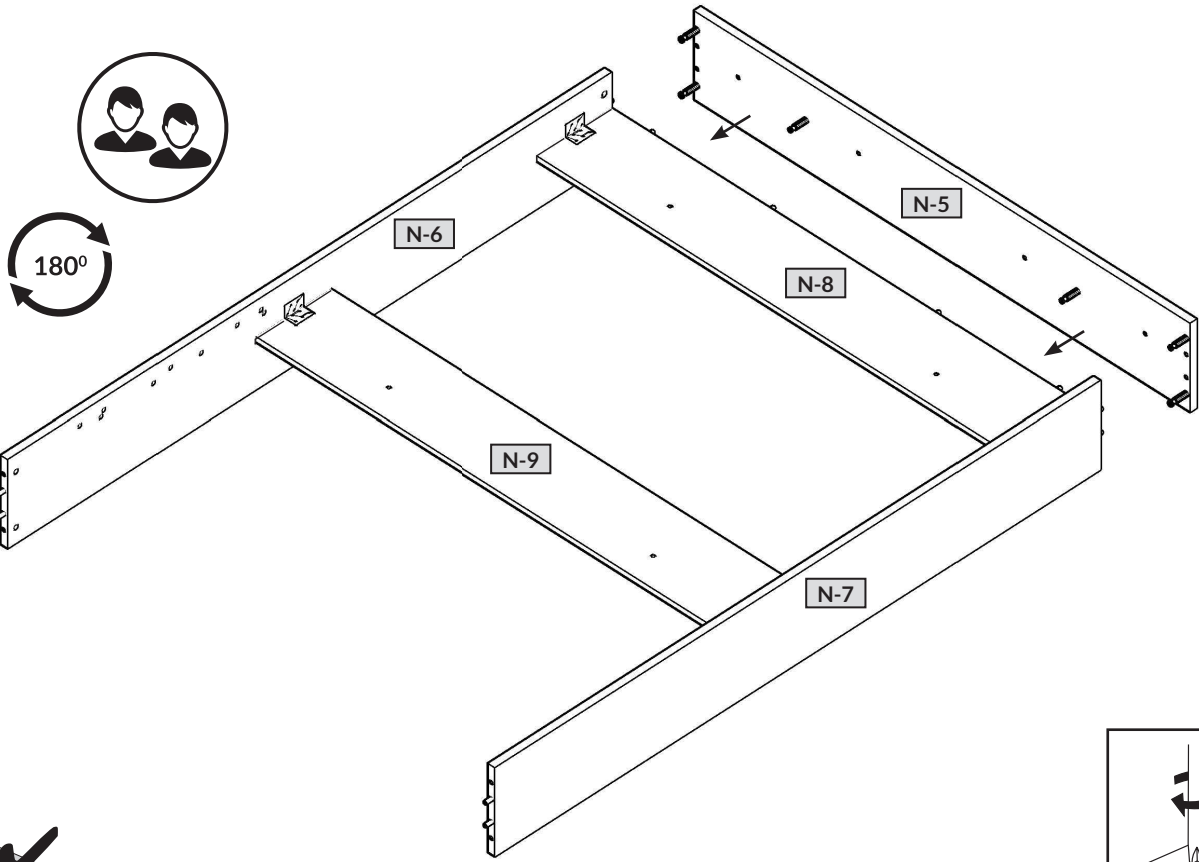

6

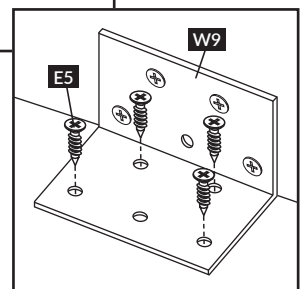
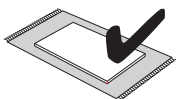
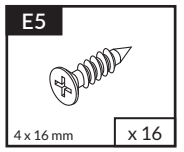
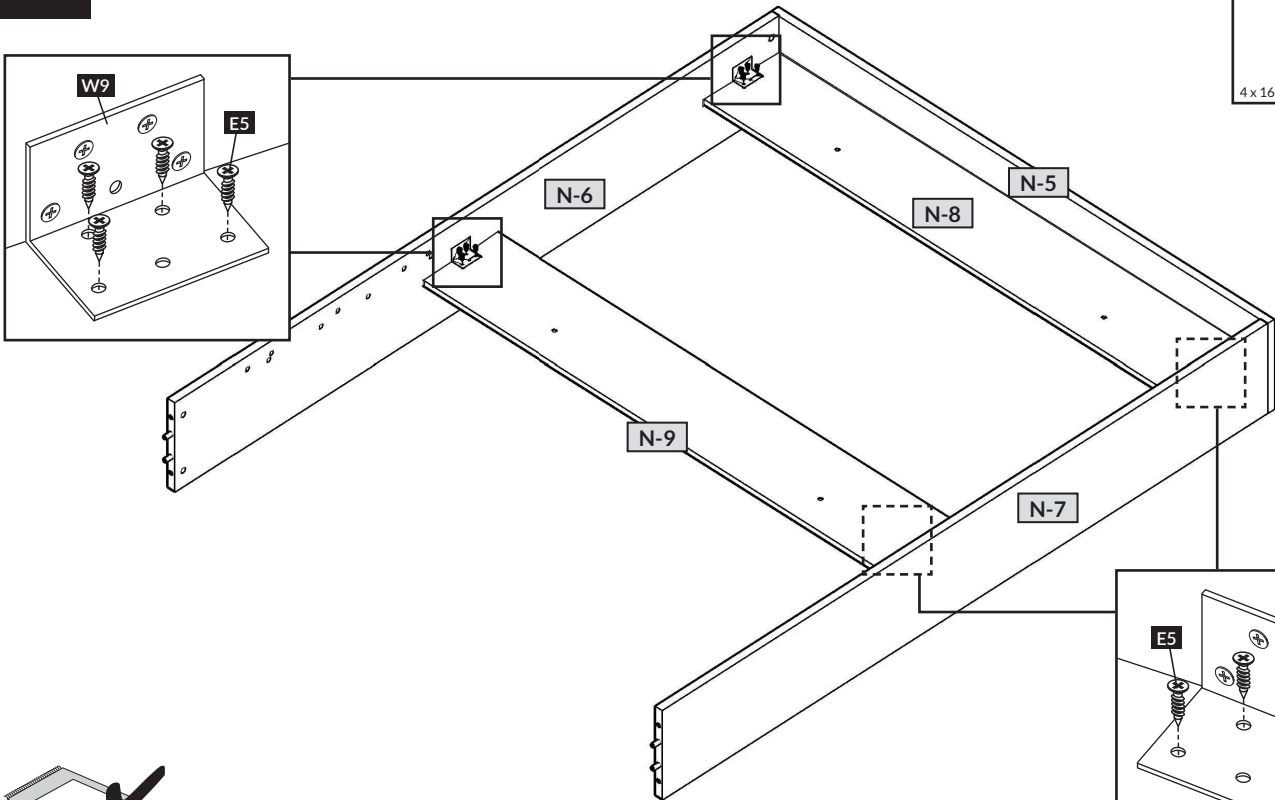



7

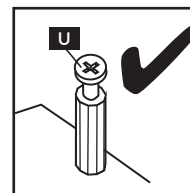
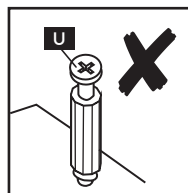
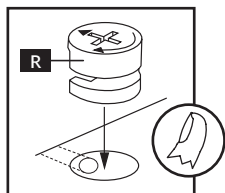
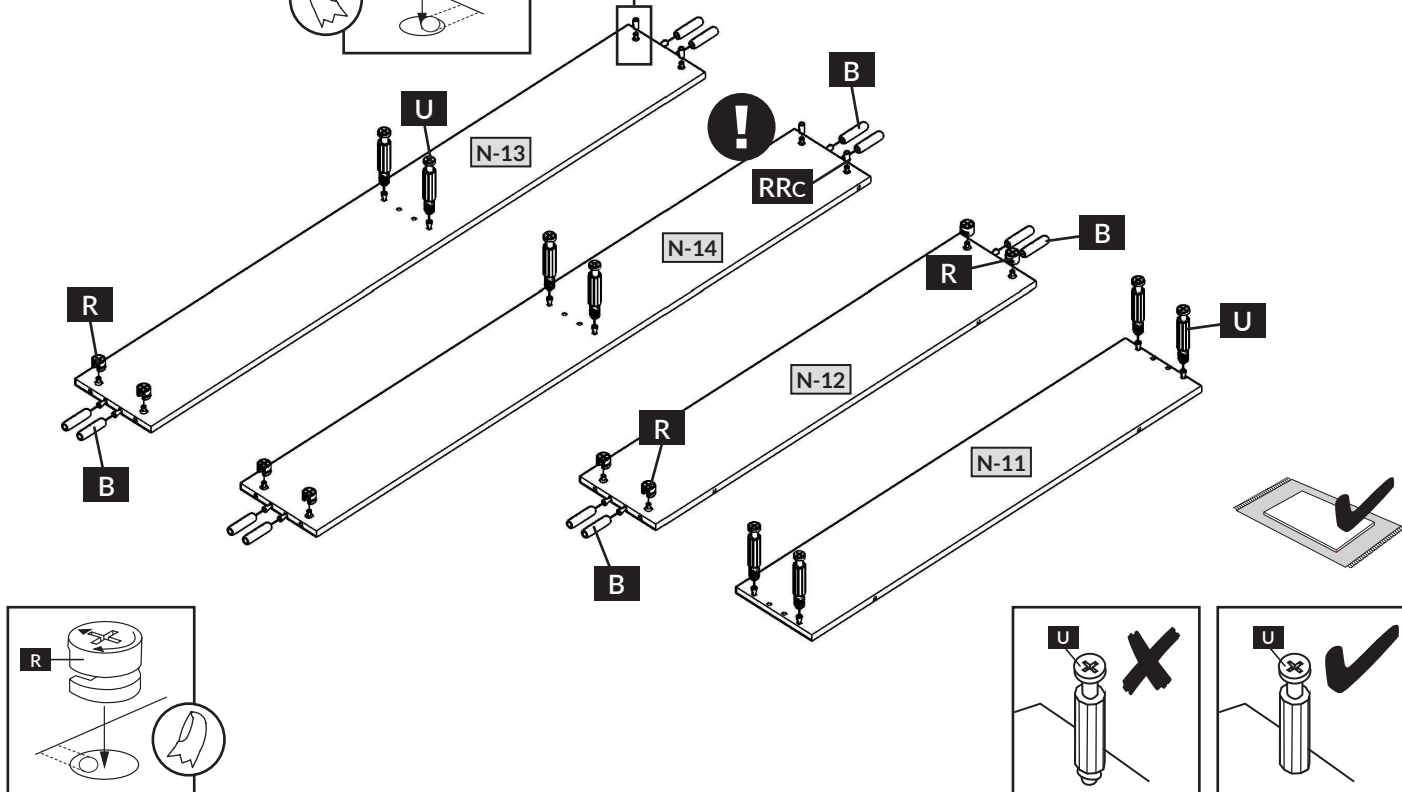
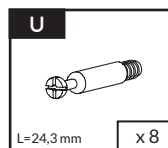
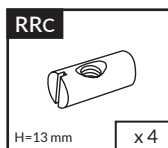
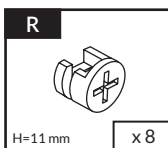
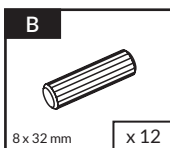
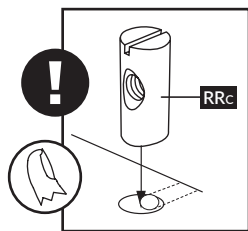

8

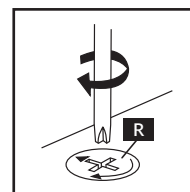
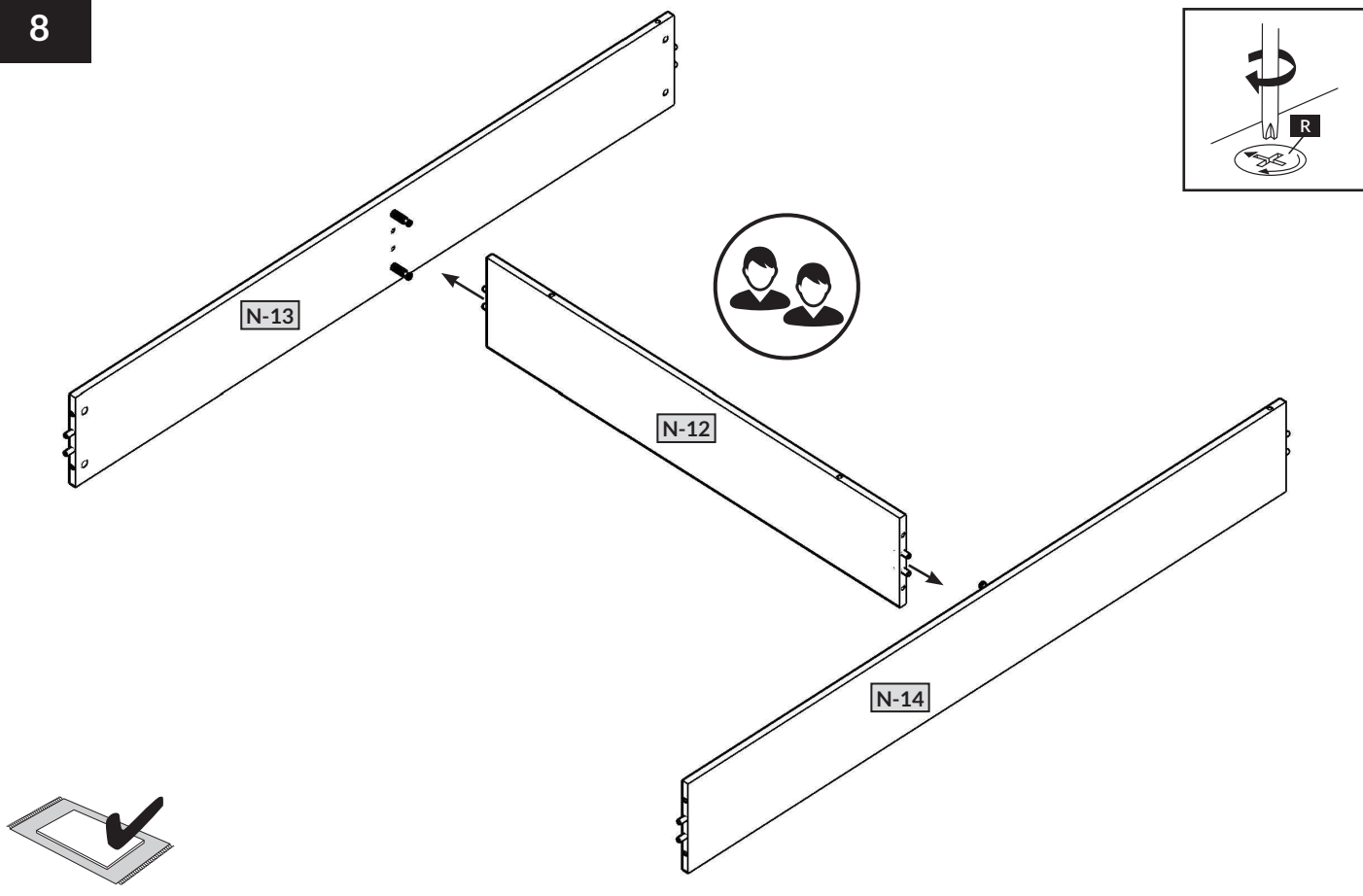



9

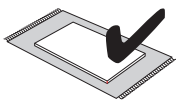
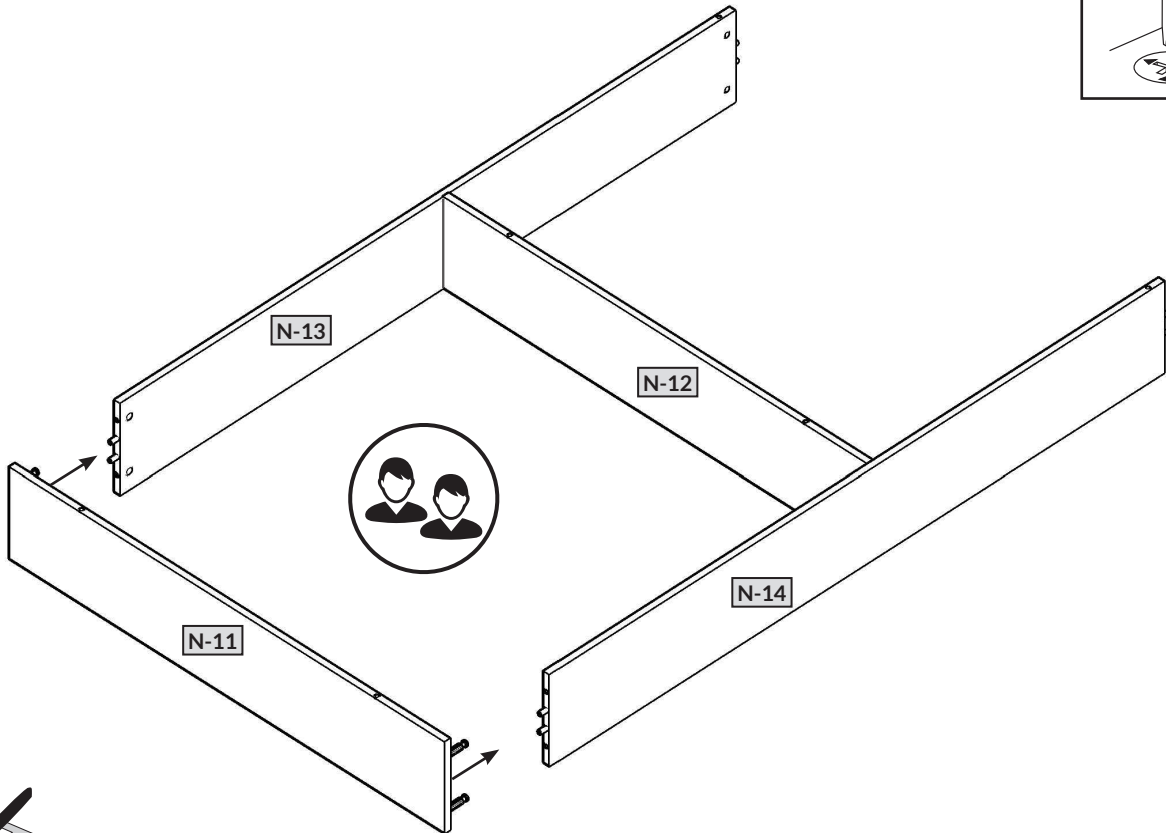
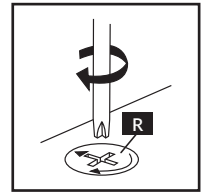

10

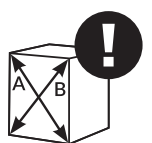
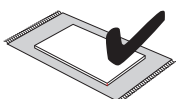
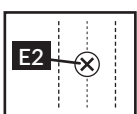
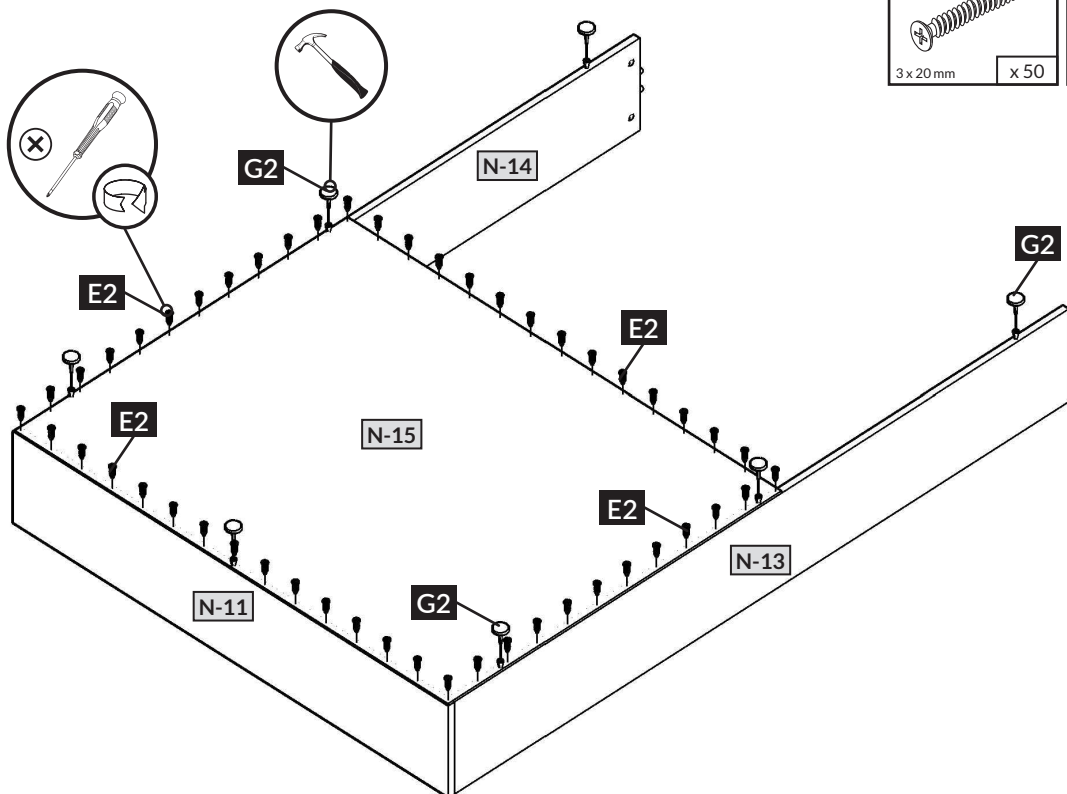
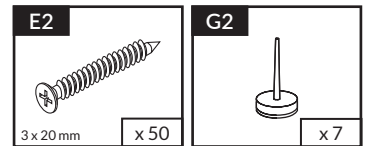



11

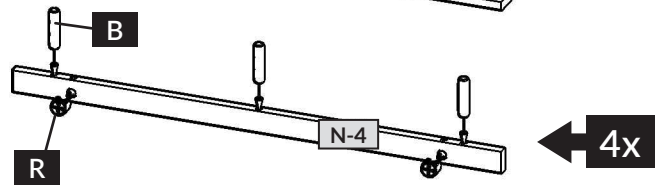
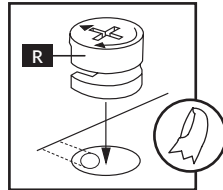
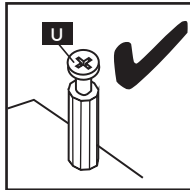
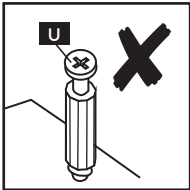
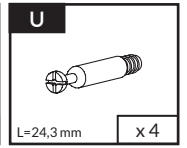
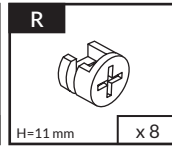
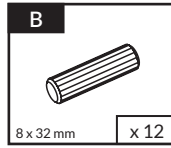
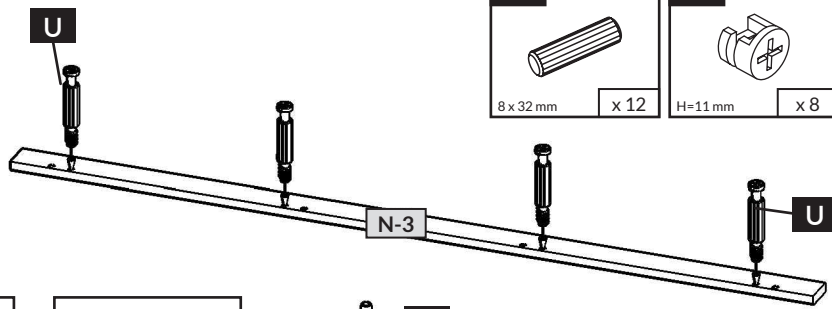
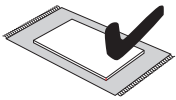

12

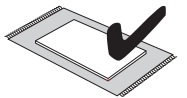
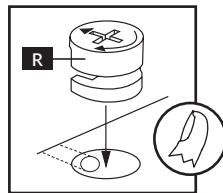
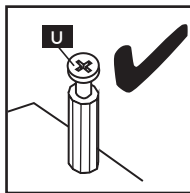
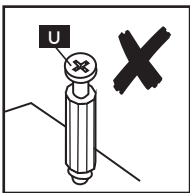
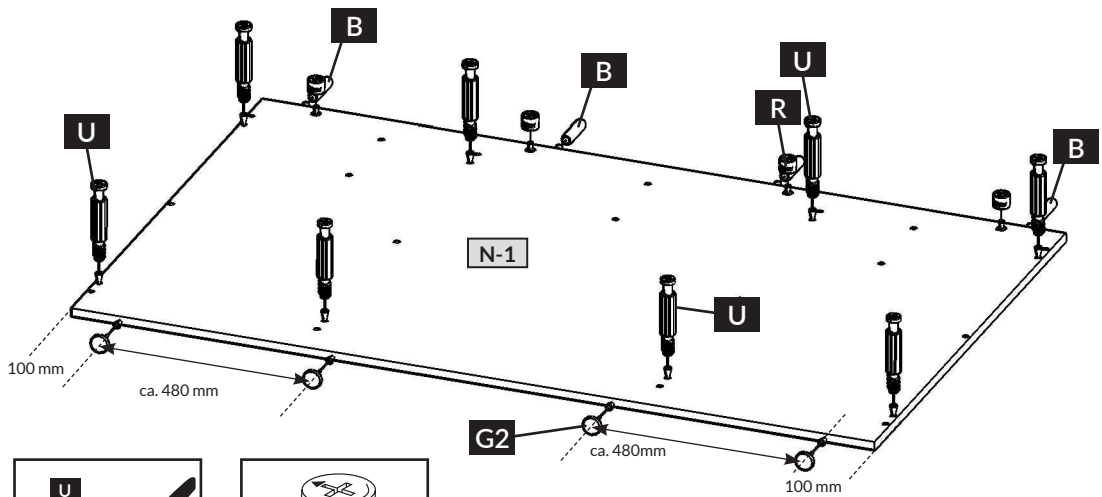
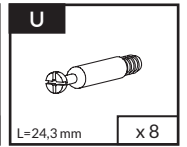
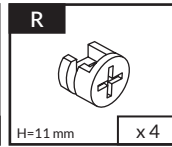
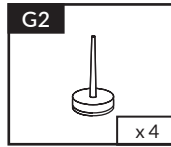
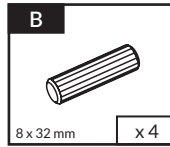

13

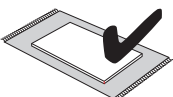
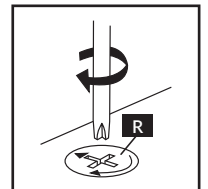
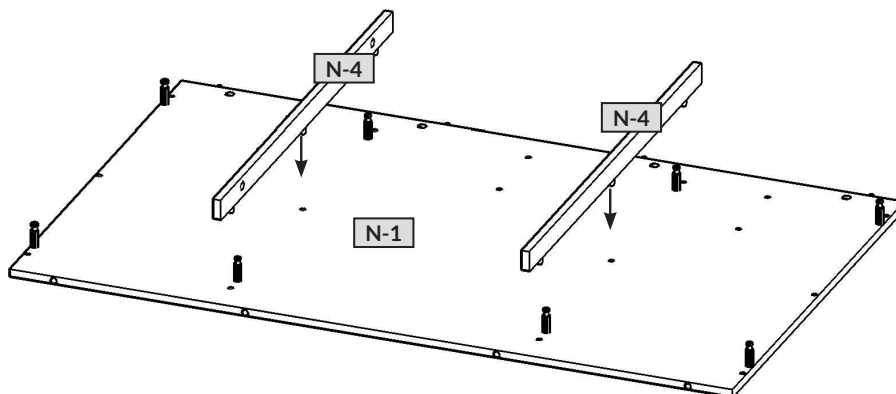



14

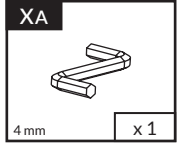
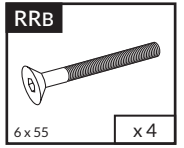
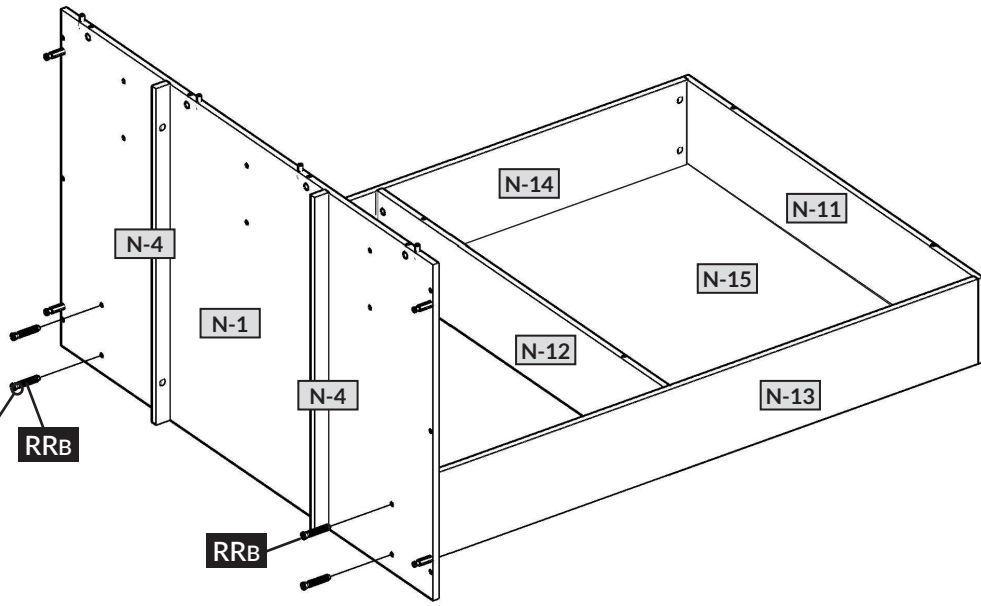
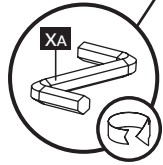

15

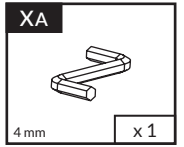
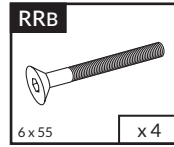
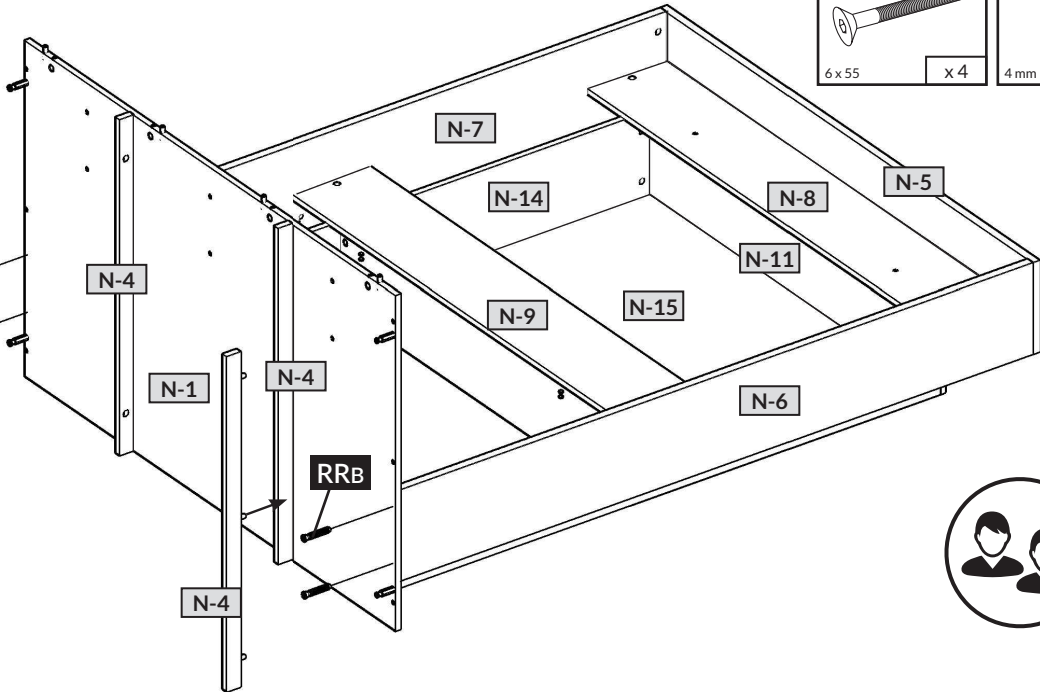
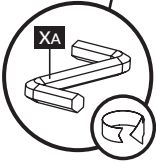
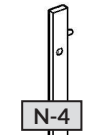

16

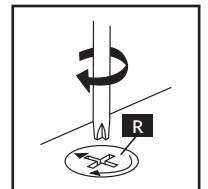
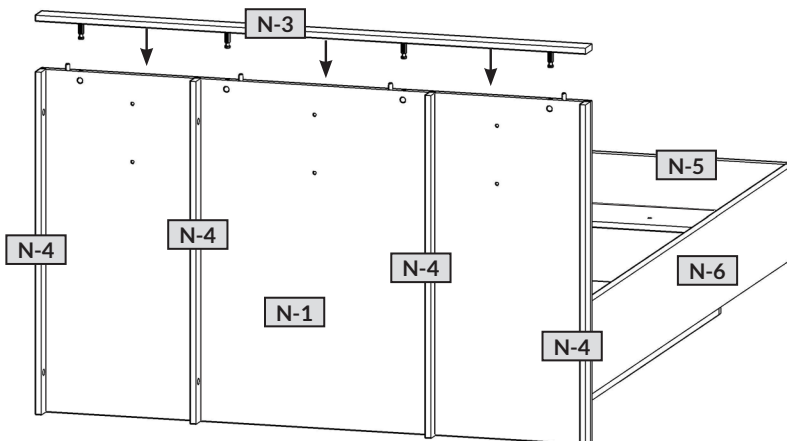



17

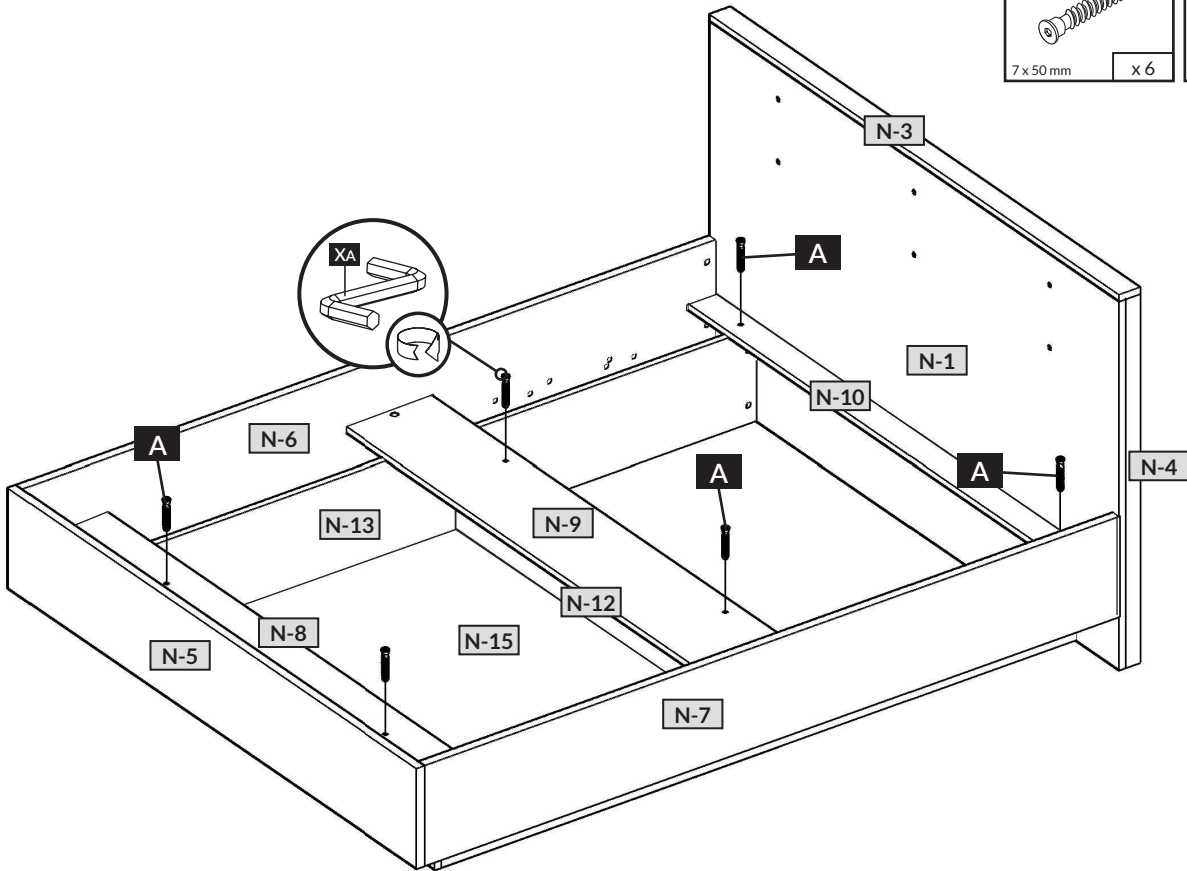
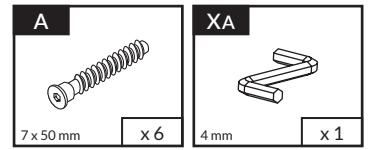

18

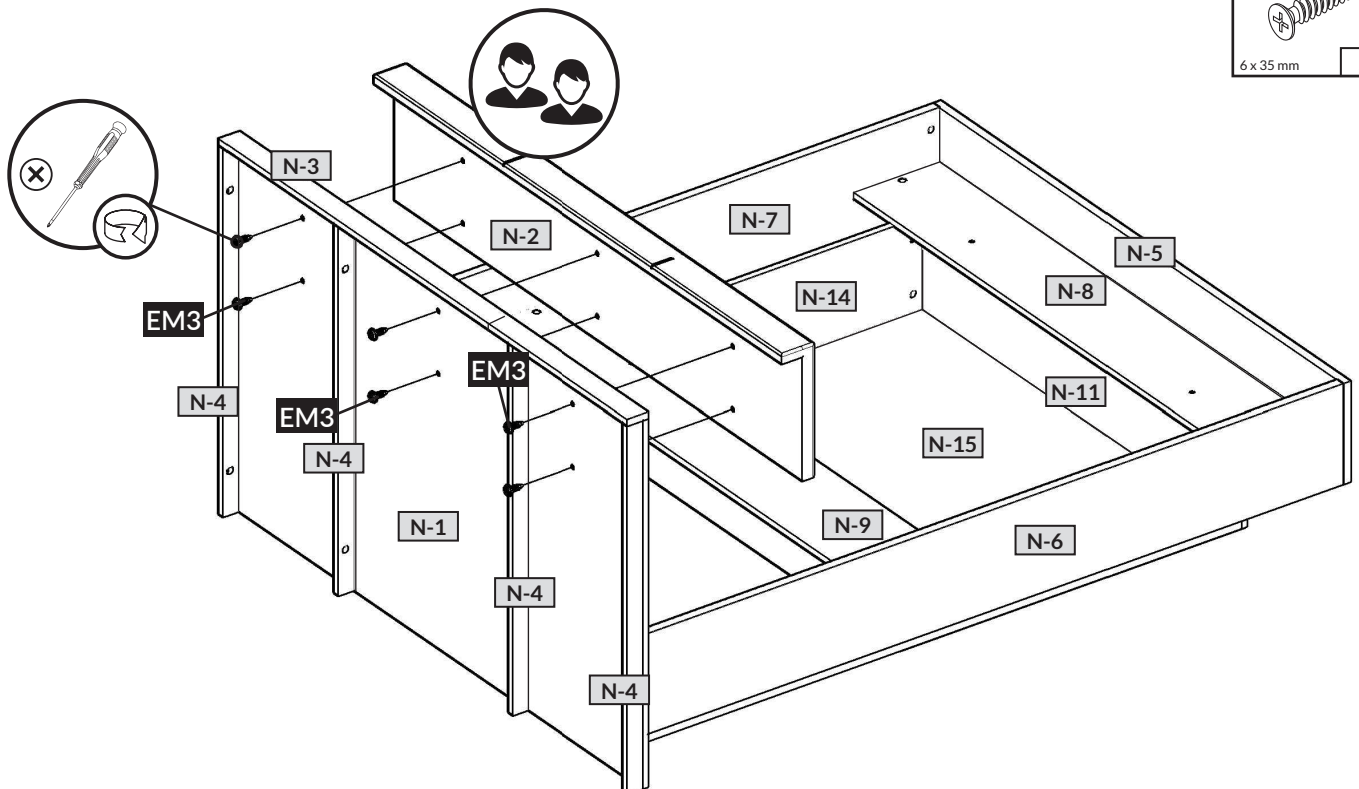
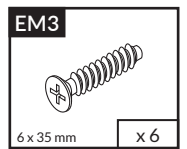



A

B

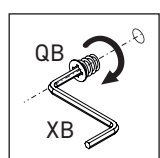
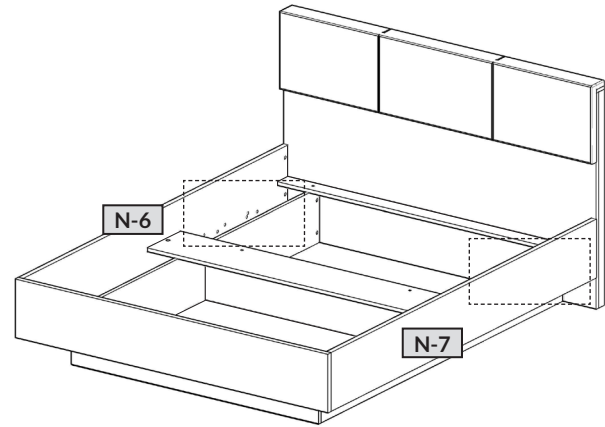
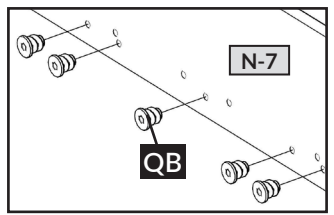
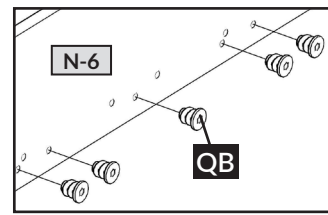
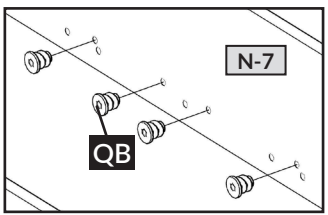
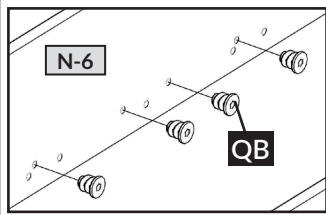
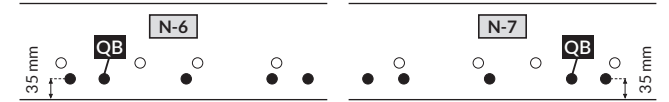
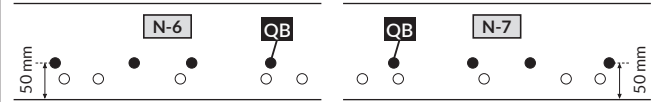
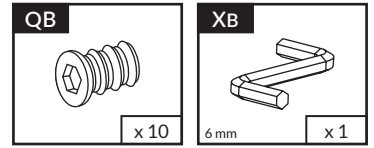
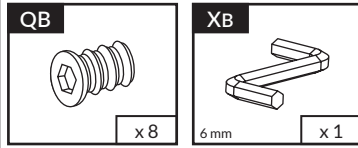
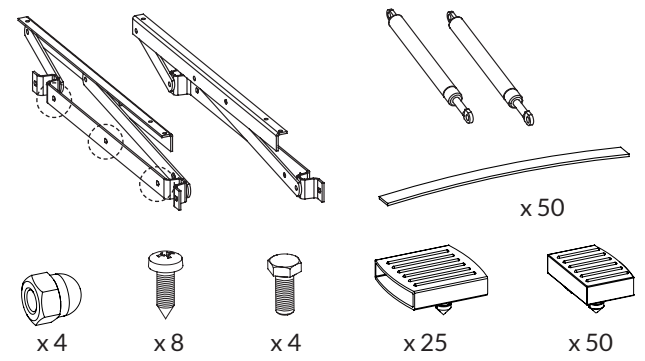
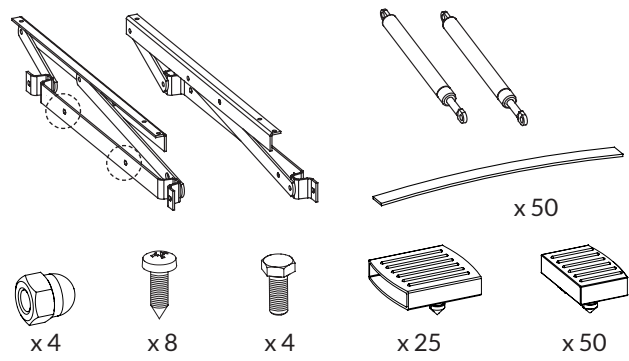
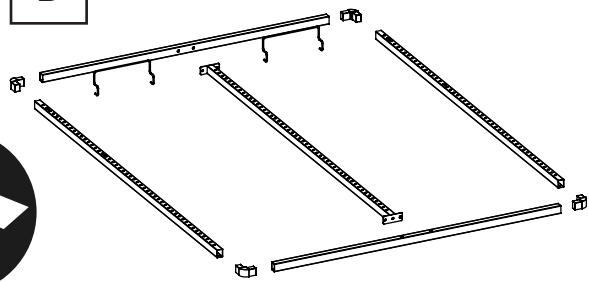
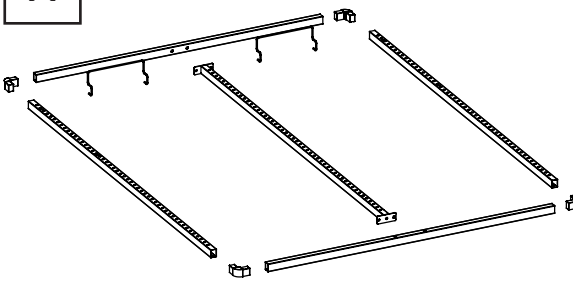



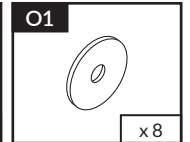
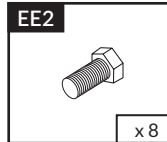
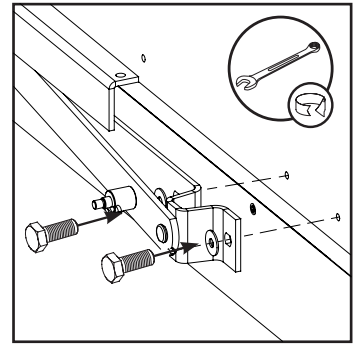
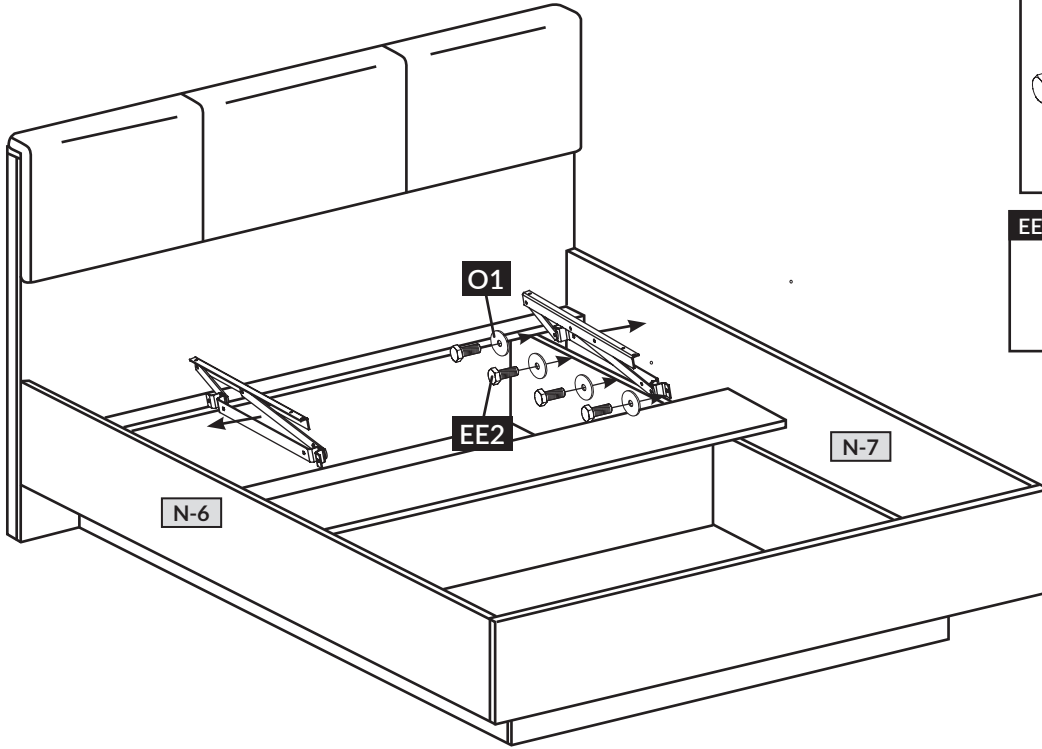

A

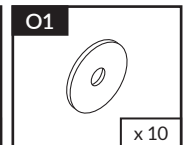
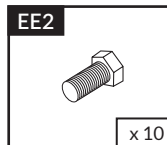
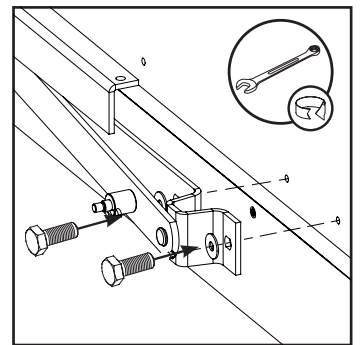
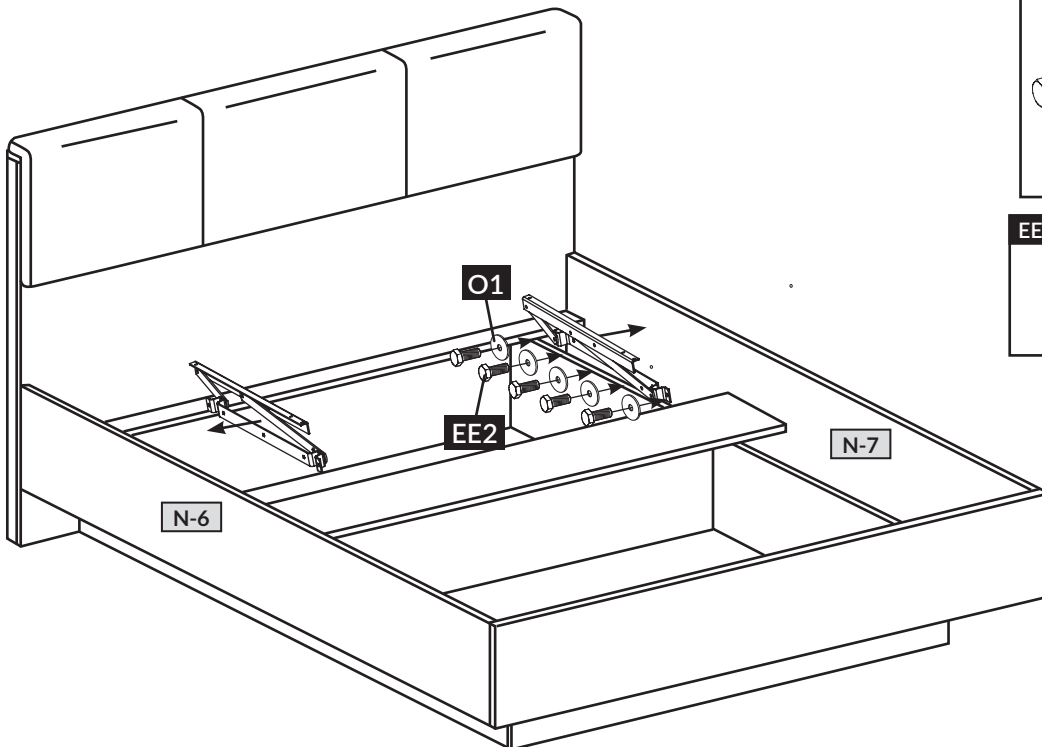

B

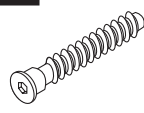
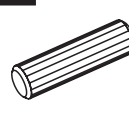
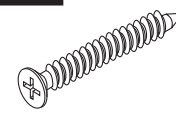
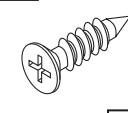
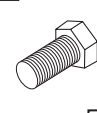
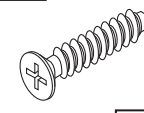

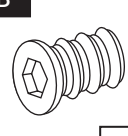
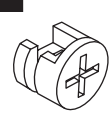
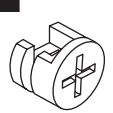
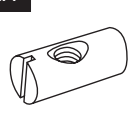
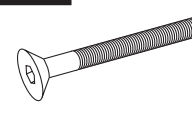
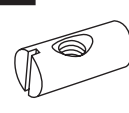
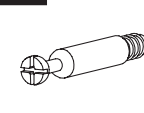
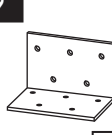
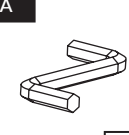
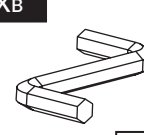
<p>A</p>  <p>7 x 50 mm X ...</p>	<p>B</p>  <p>8 x 32 mm X ...</p>	<p>E2</p>  <p>3 x 20 mm X ...</p>
<p>E5</p>  <p>4 x 16 mm X ...</p>	<p>EE2</p>  <p> X ...</p>	<p>EM3</p>  <p>6 x 35 mm X ...</p>
<p>G2</p>  <p> X ...</p>	<p>O1</p>  <p> X ...</p>	<p>QB</p>  <p> X ...</p>
<p>R</p>  <p>H=11 mm X ...</p>	<p>R1</p>  <p>H=15 mm X ...</p>	<p>RRa</p>  <p>H=16 mm X ...</p>
<p>RRb</p>  <p>6 x 55 X ...</p>	<p>RRc</p>  <p>H=13 mm X ...</p>	<p>U</p>  <p>L=24,3 mm X ...</p>
<p>W9</p>  <p> X ...</p>	<p>Xa</p>  <p>4 mm X ...</p>	<p>Xb</p>  <p>6 mm X ...</p>

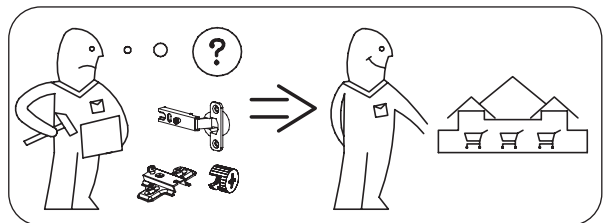
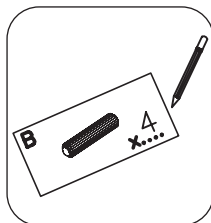

nr	↔ [mm]	↓ [mm]	∅ [mm]	Menge	Colli
N-1	1645	1000	16	x1	2/2
N-2	1360	320	25	x1	1/2
N-3	1645	60	16	x1	1/2
N-4	1000	44	16	x4	2/2
N-5	1645	272	22	x1	2/2
N-6	2022	270	22	x1	1/2
N-7	2022	270	22	x1	1/2
N-8	1600	250	16	x1	1/2
N-9	1600	250	16	x1	1/2
N-10	1600	80	16	x1	1/2
N-11	1301	250	16	x1	2/2
N-12	1268	250	16	x1	2/2
N-13	1850	250	16	x1	1/2
N-14	1850	250	16	x1	1/2
N-15	1296	1002	3	x1	2/2

