

C-1	1531	395	16	x 1	1/2
C-2	1531	395	16	x 1	1/2
C-3	632	394	16	x 1	1/2
C-4	632	394	16	x 1	1/2
C-5	632	372	16	x 1	1/2
C-6	632	345	16	x 1	1/2
C-7	492	335	16	x 2	1/2
C-8	482	300	16	x 1	1/2
C-9	632	90	16	x 1	1/2
C-10	628	24	16	x 1	1/2
C-11	426	626	16	x 1	2/2
C-12	496	626	16	x 2	2/2
C-13	1512	646	3	x 1	1/2

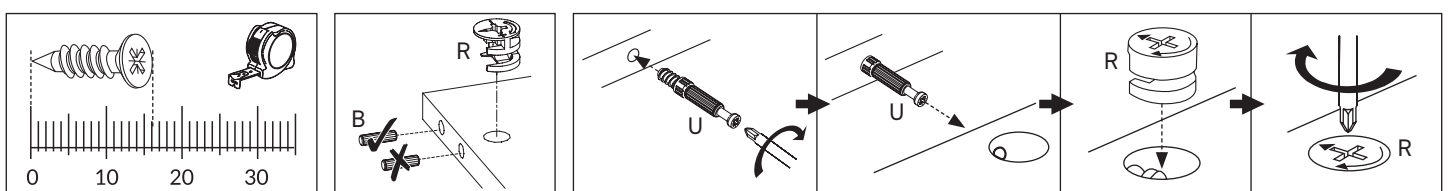

1

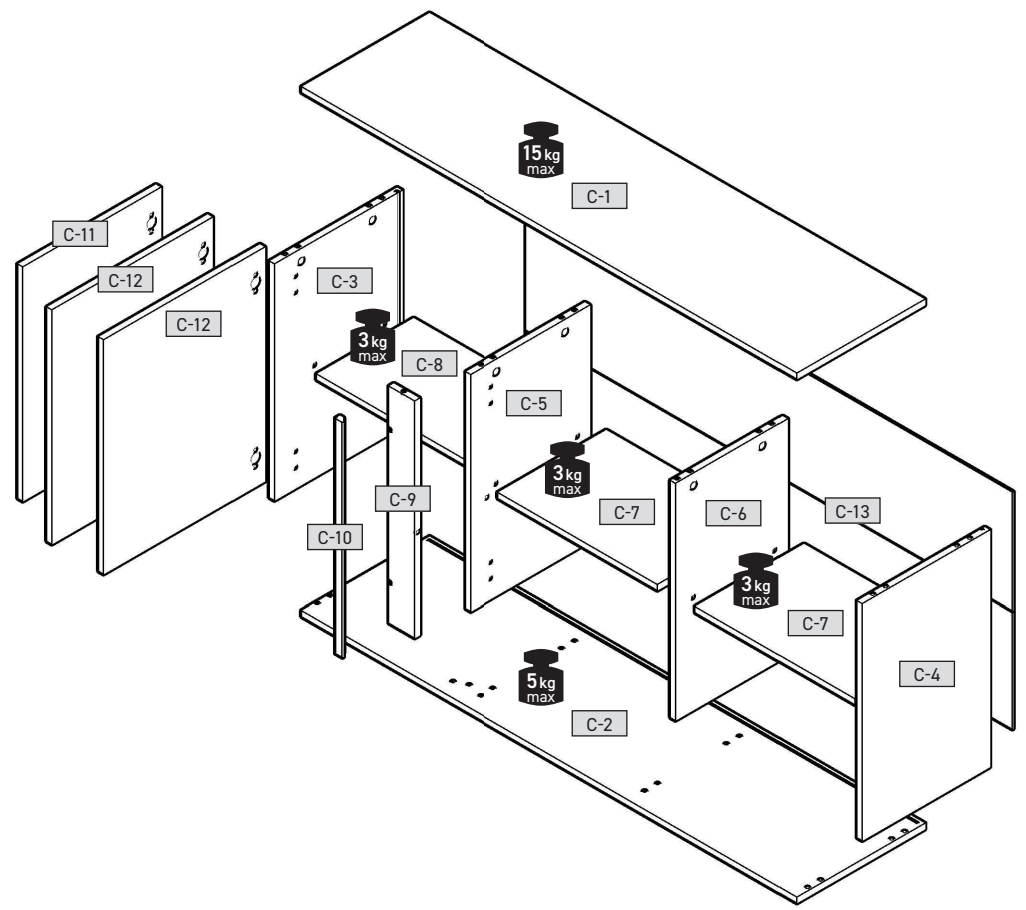
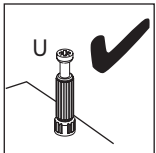
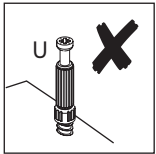
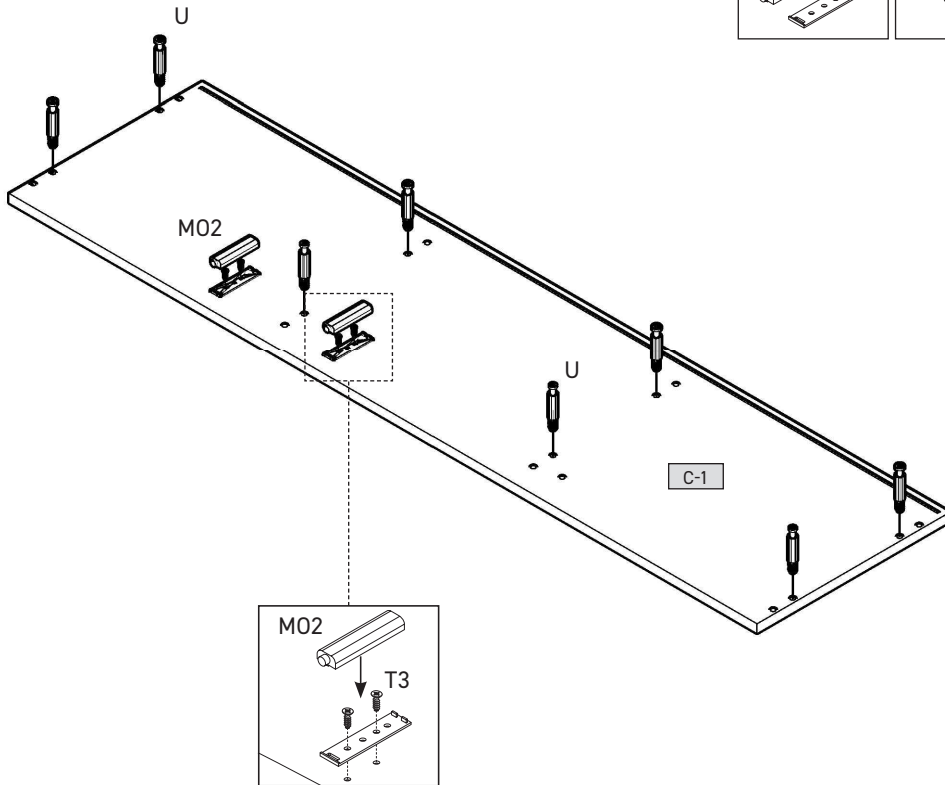
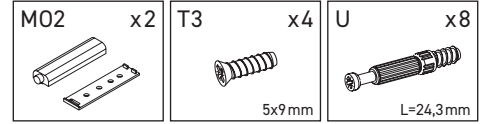

2

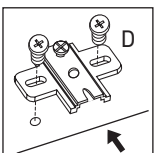
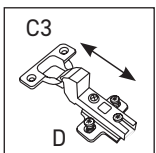
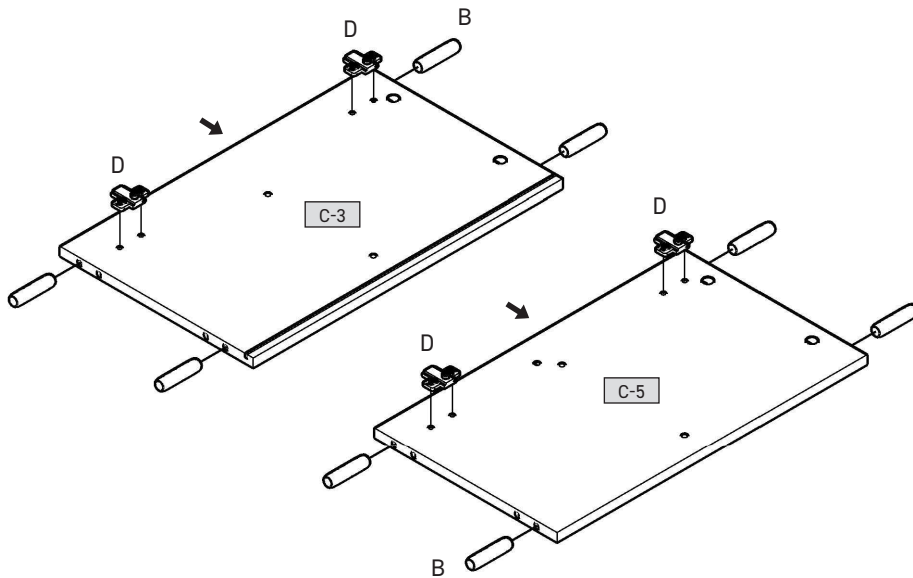
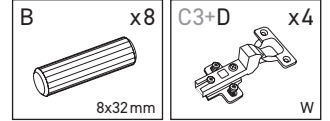

3

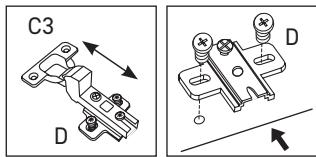
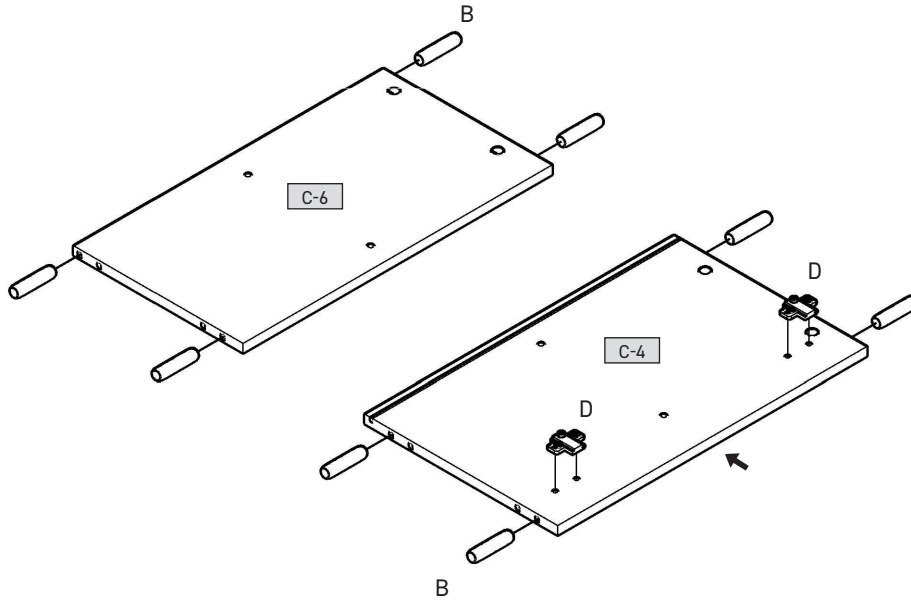
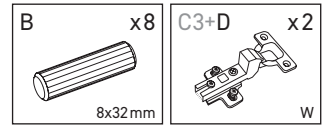

4

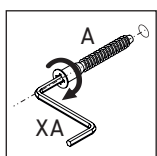
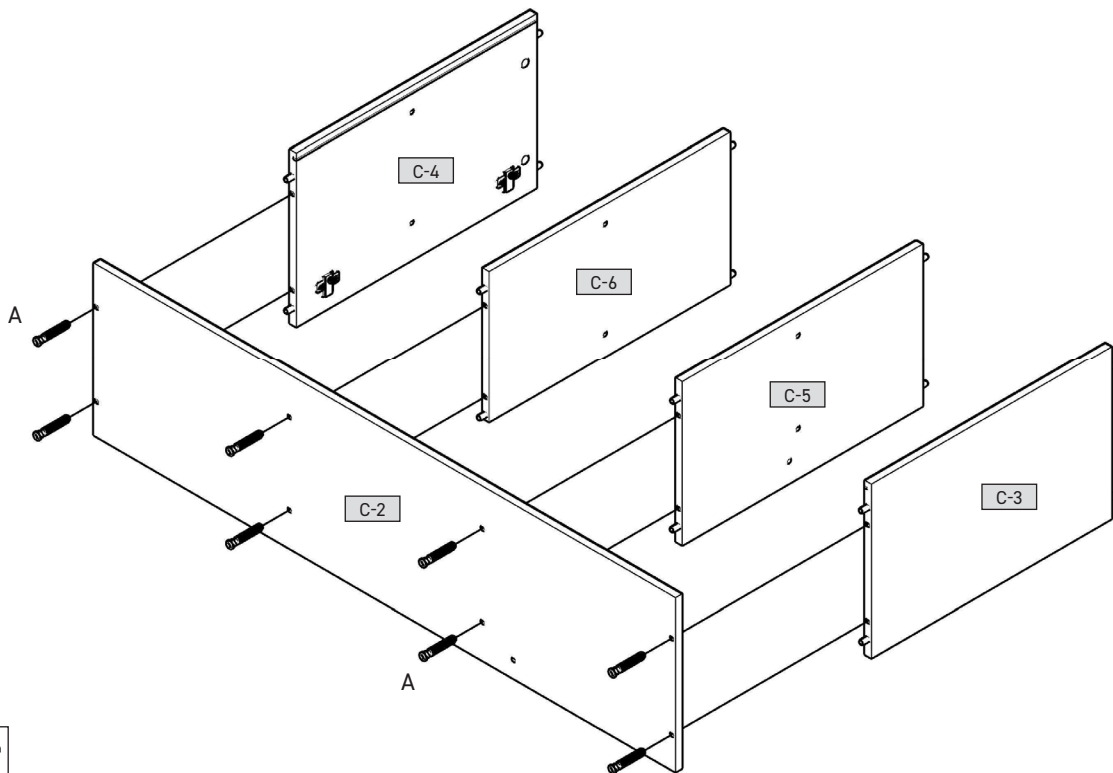
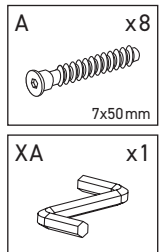

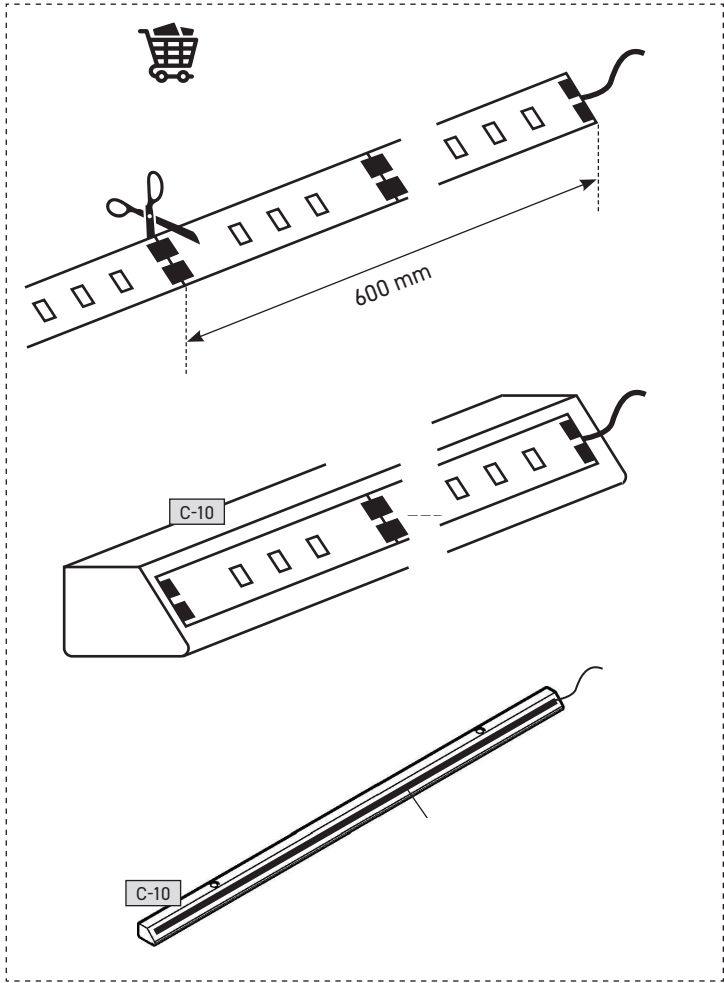

5

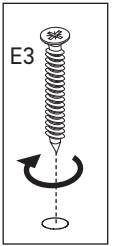
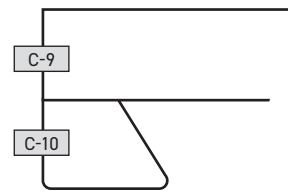
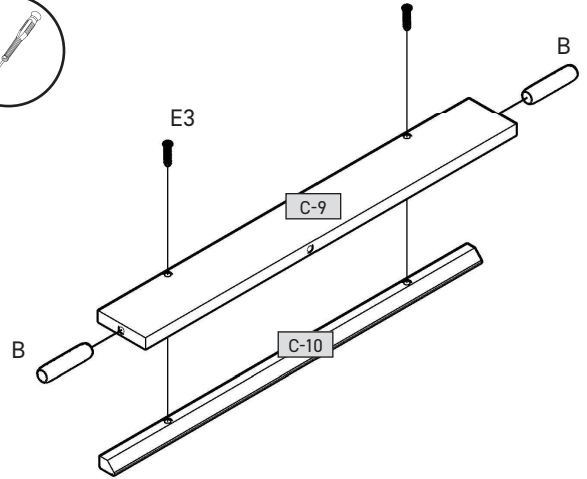
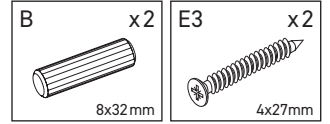

6

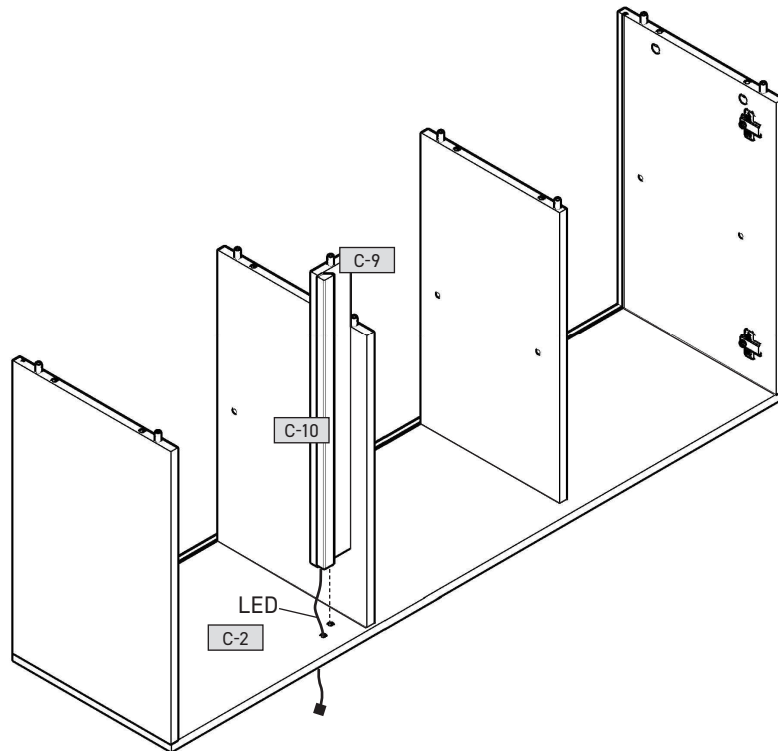
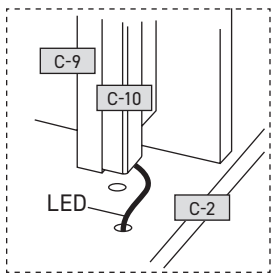

7

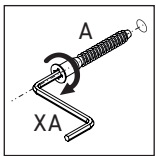
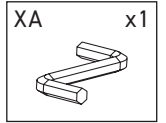
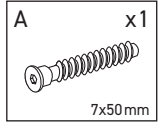
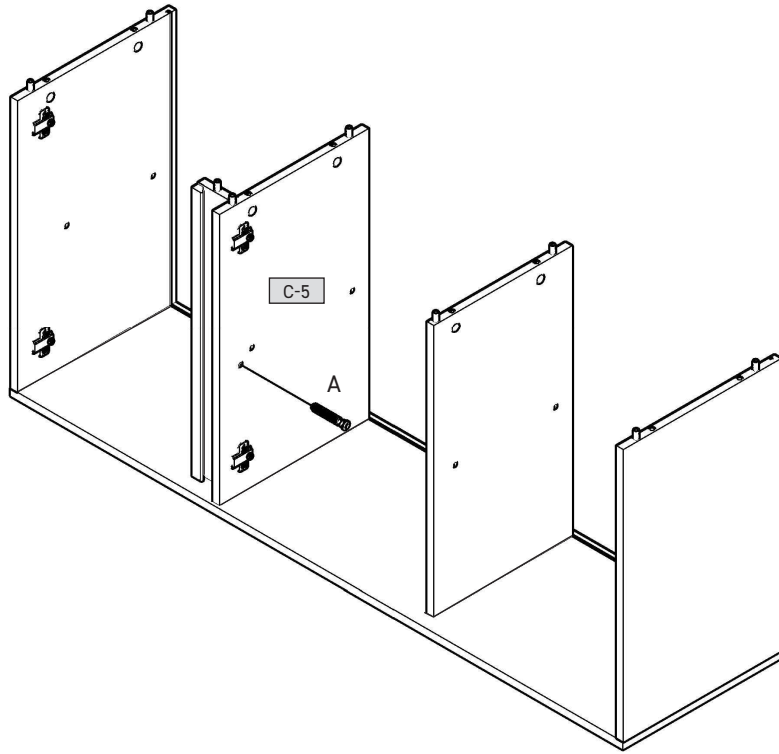

8

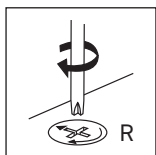
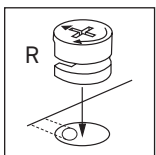
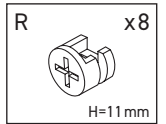
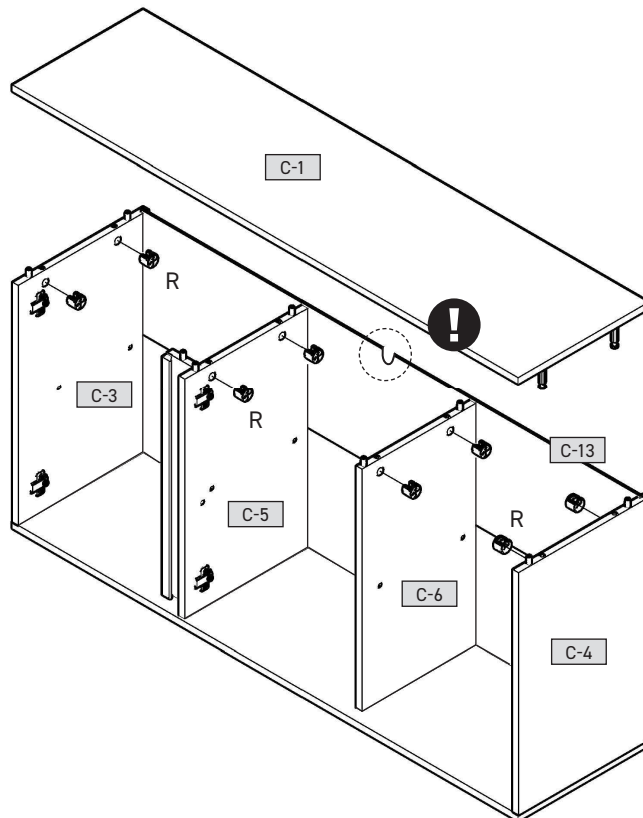

9

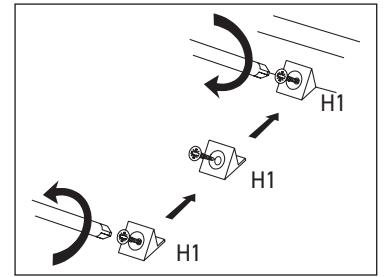
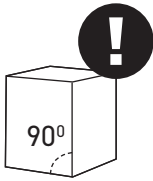
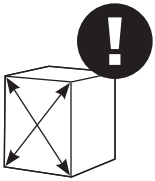
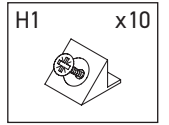
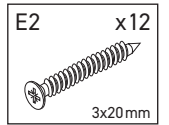
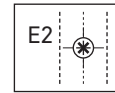
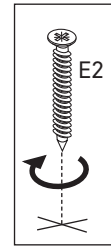
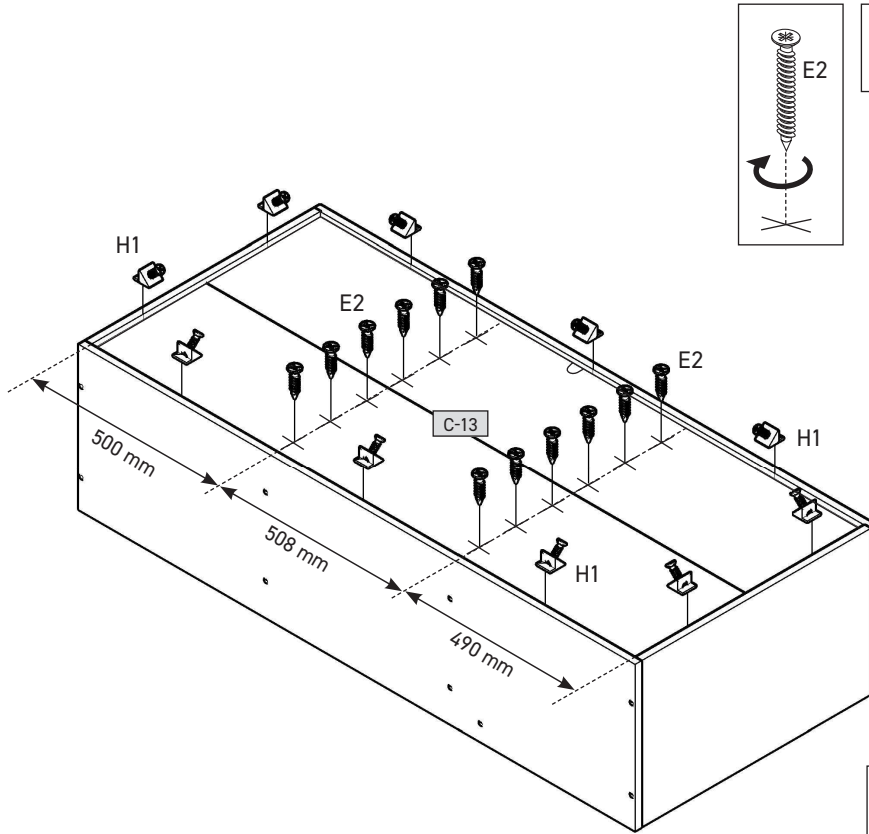

10

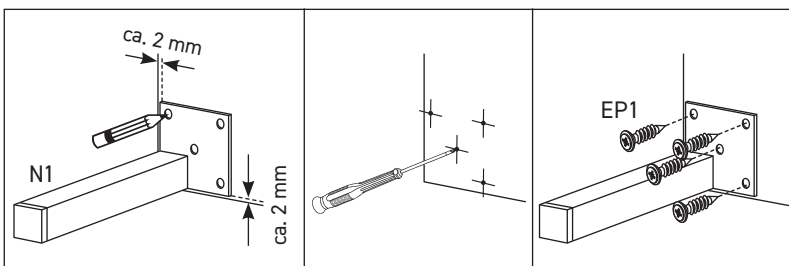
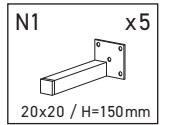
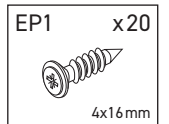
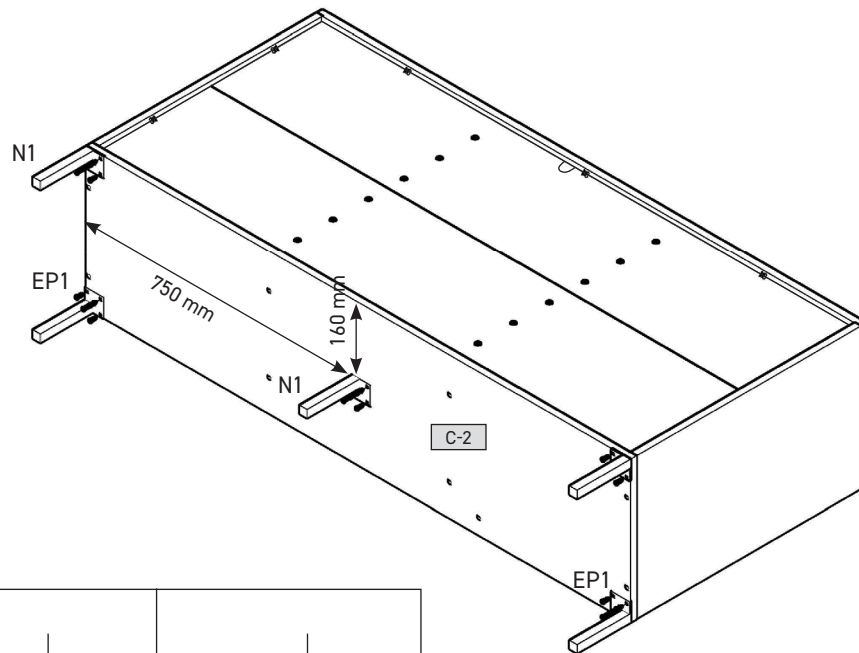
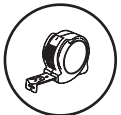



11

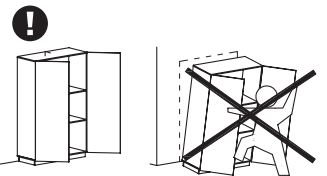
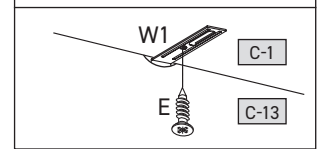
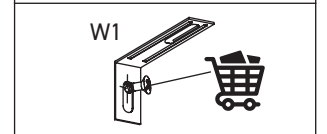
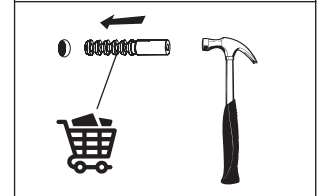
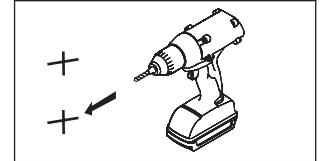
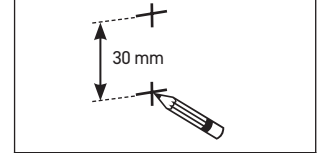
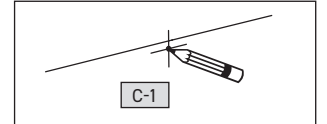
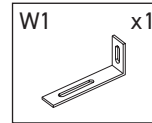
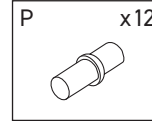
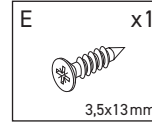
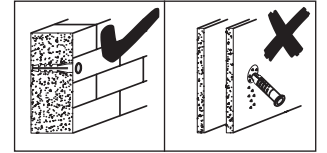
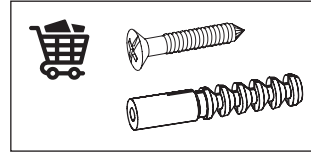
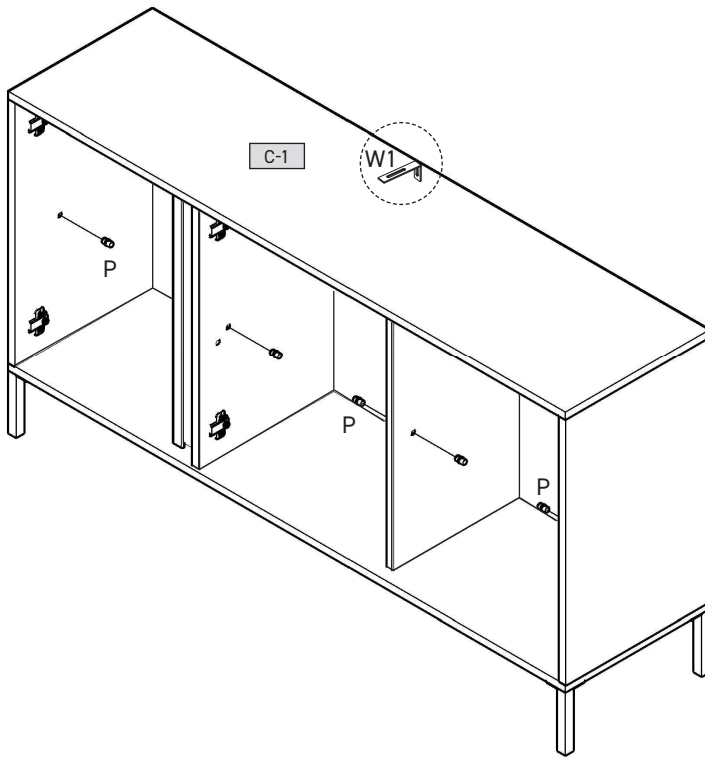
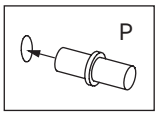
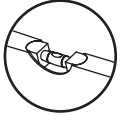

12

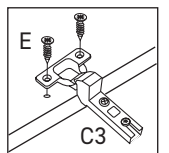
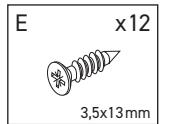
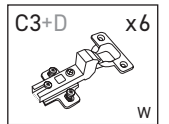
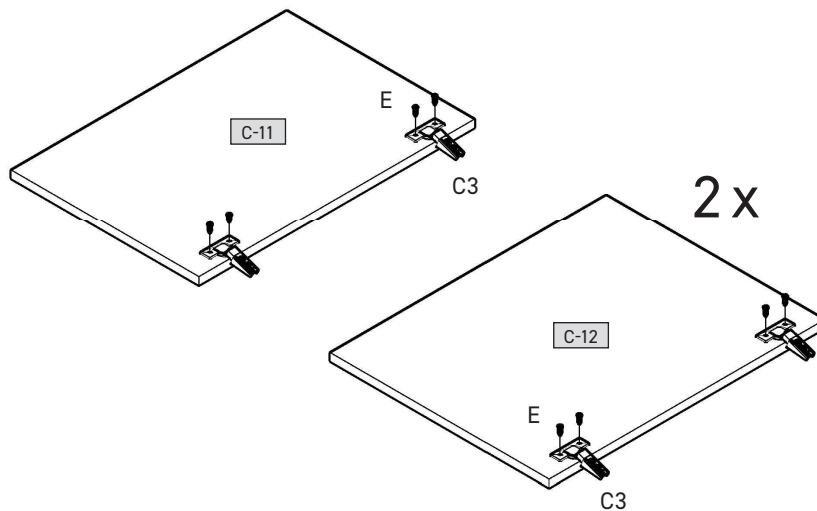

13

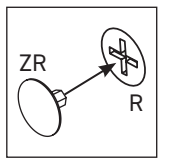
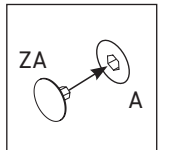
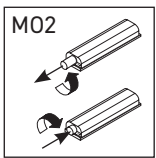
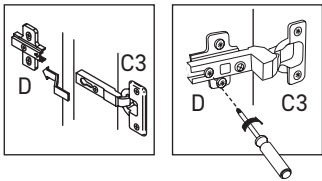
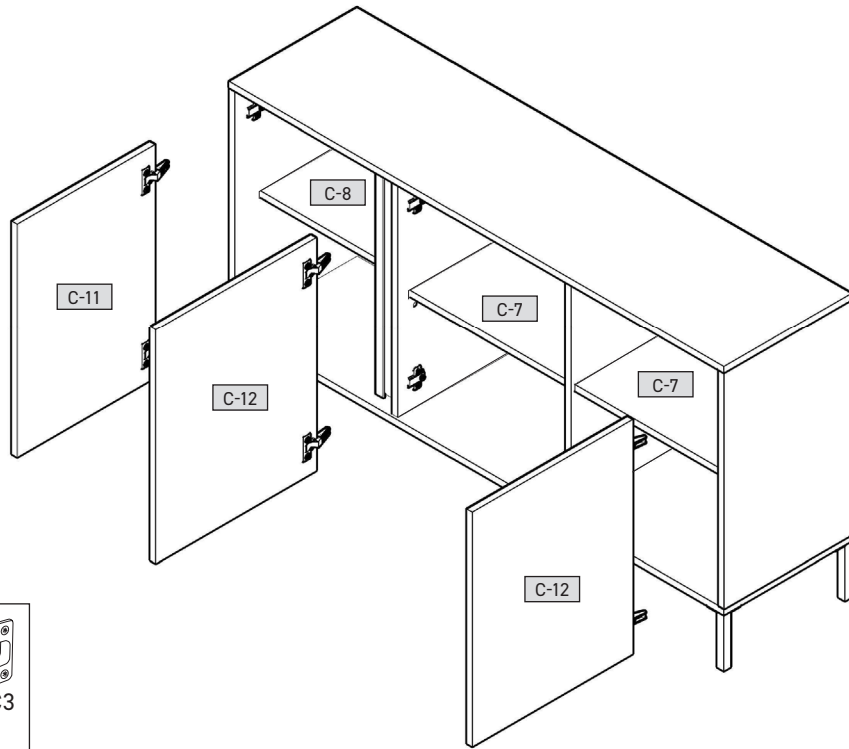
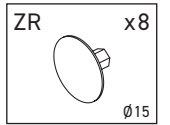
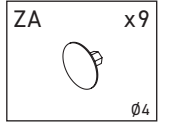

14

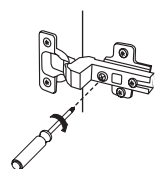
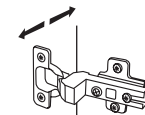
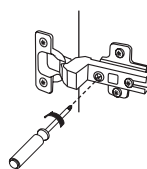
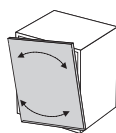
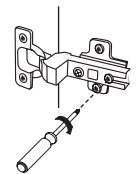
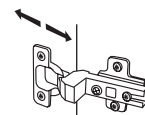
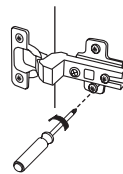
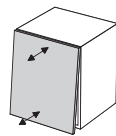
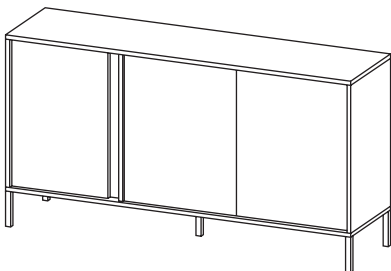
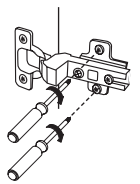
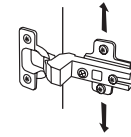
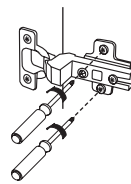
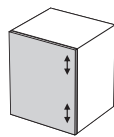

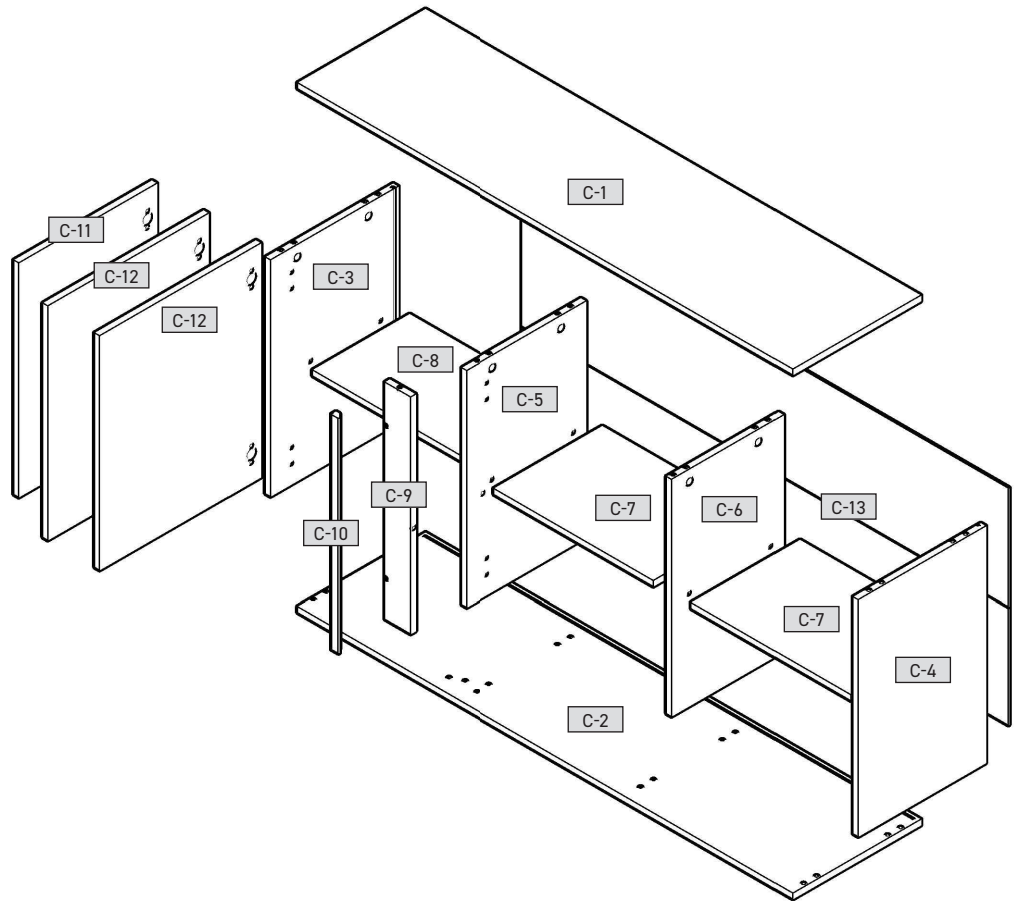
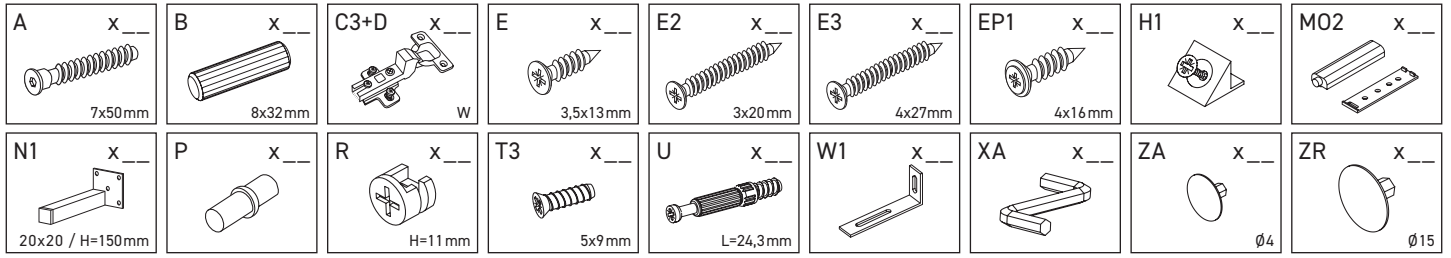

C-1	1531	395	16	x 1	1/2
C-2	1531	395	16	x 1	1/2
C-3	632	394	16	x 1	1/2
C-4	632	394	16	x 1	1/2
C-5	632	372	16	x 1	1/2
C-6	632	345	16	x 1	1/2
C-7	492	335	16	x 2	1/2
C-8	482	300	16	x 1	1/2
C-9	632	90	16	x 1	1/2
C-10	628	24	16	x 1	1/2
C-11	426	626	16	x 1	2/2
C-12	496	626	16	x 2	2/2
C-13	1512	646	3	x 1	1/2

