

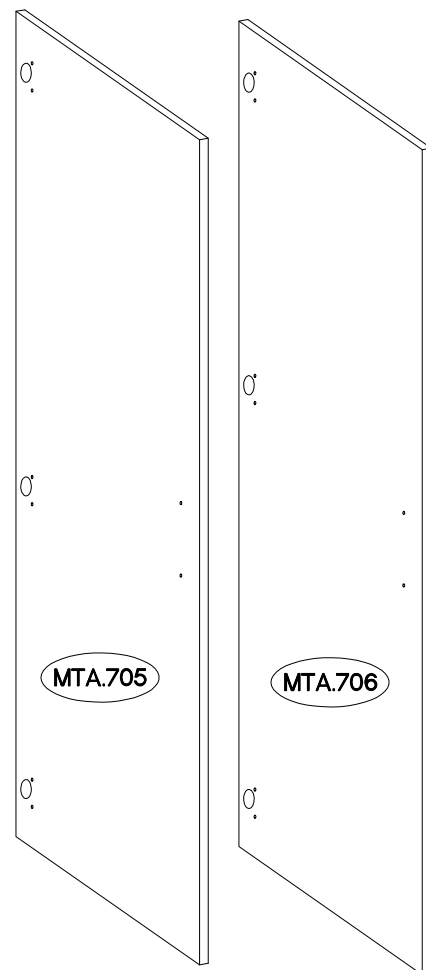

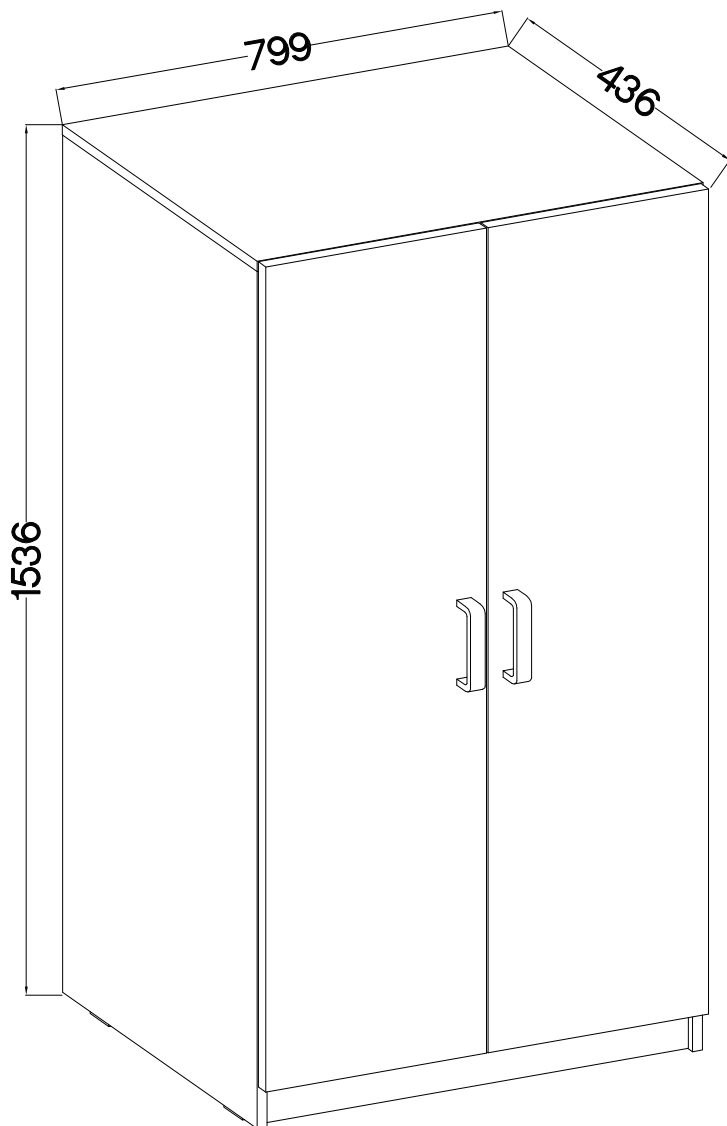

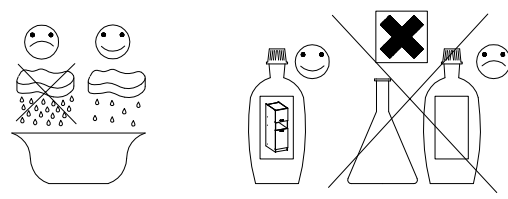

30 min



 [CD] HG	 P5	 S	 U
6	12	2	4

MTA.705	1456x395x16
MTA.706	1456x395x16

1

 HG 6	 P5 12
---	--

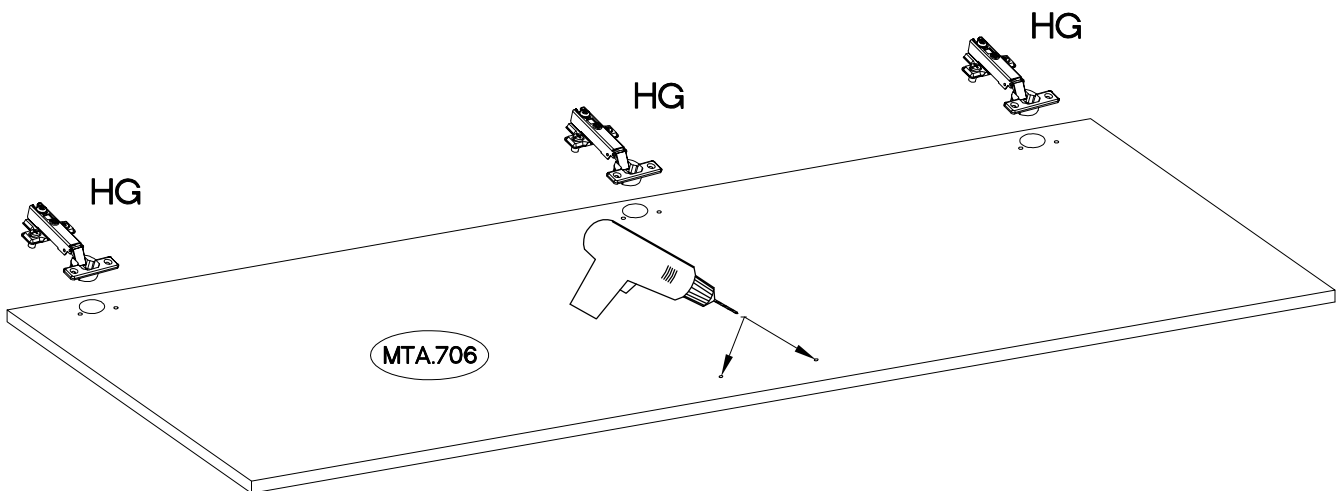
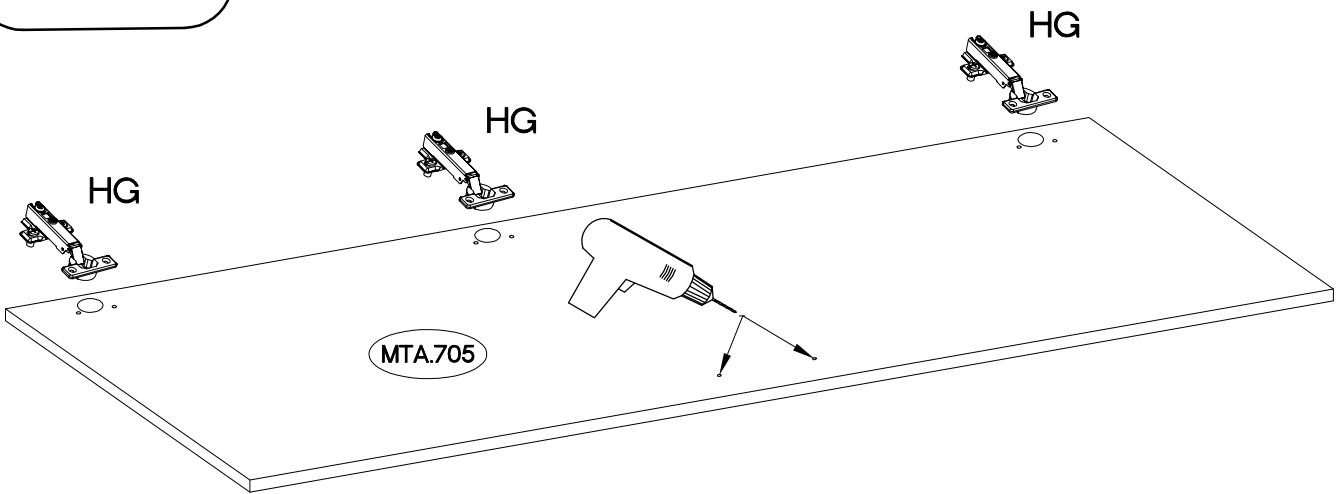
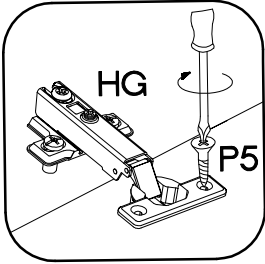
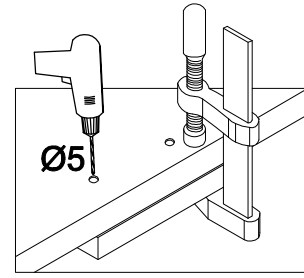
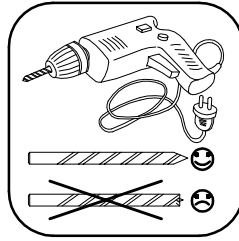

2

TYP 107

L=128mm M4x22mm

