

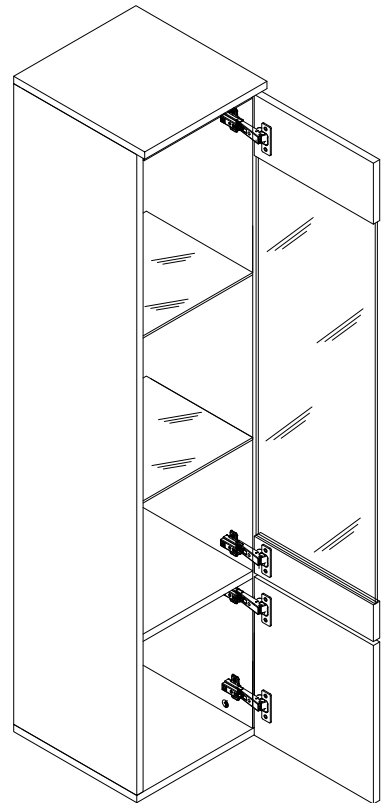

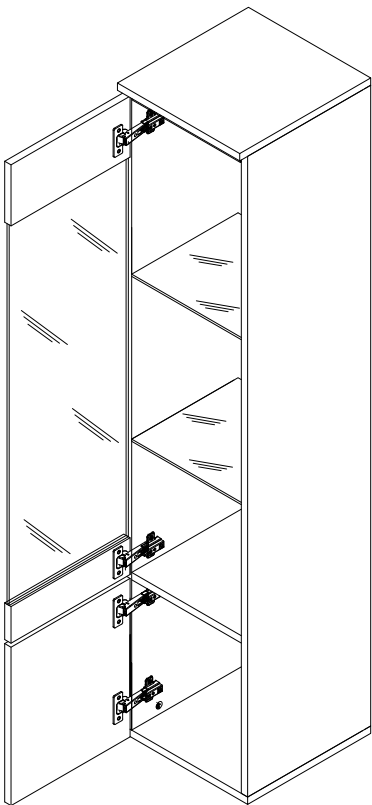

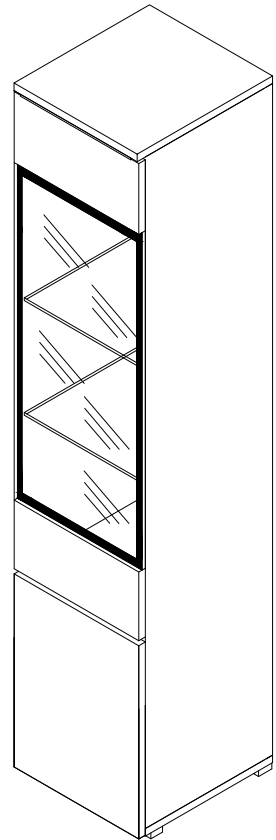
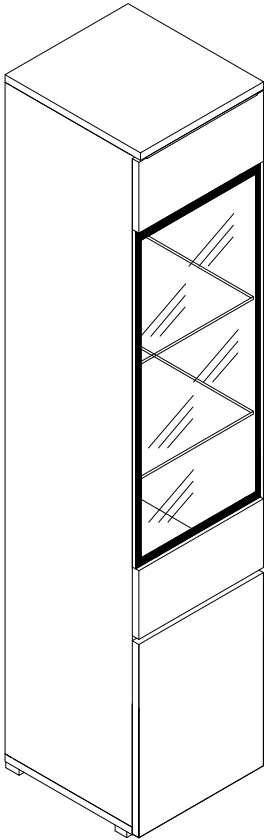
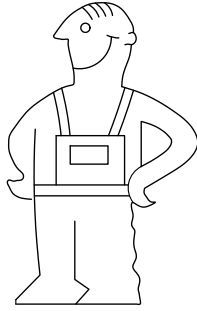
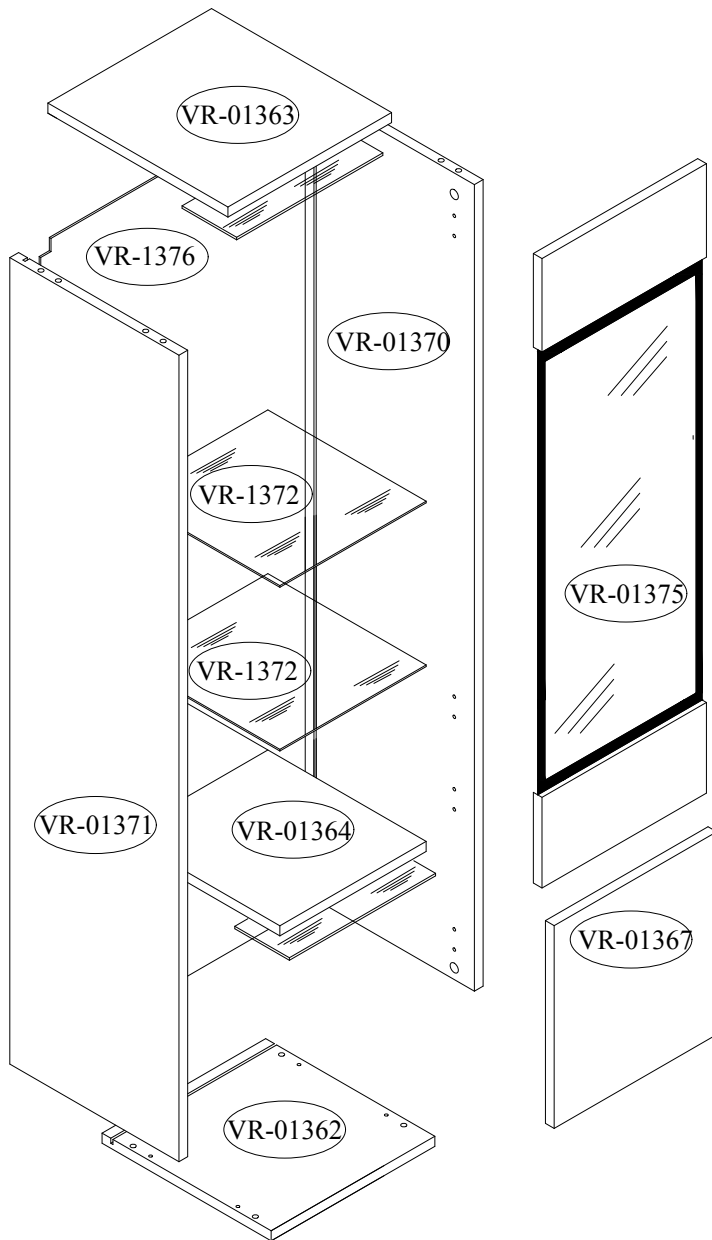
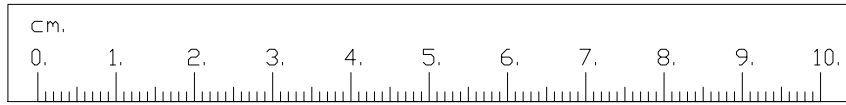
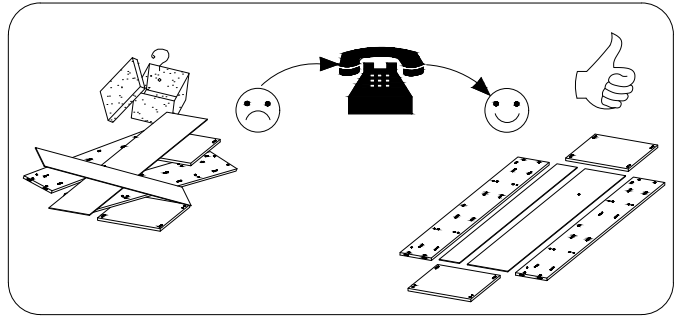
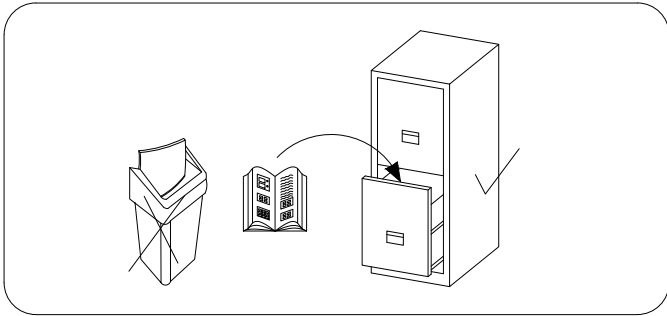

?

**L**



**R**















 A	 S3	 G	4.0x30  H1	8.0x30  D	 B
4	16	2	4	8	8

 A
8







 B	8.0x30  D
4	4

6.3X13  F	 Z
8	4

## VII - VIII - X - XI





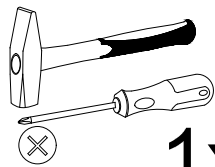

 X	 I	3.0x13  H	 S4	 M	4.0x25  G	 L	 MS	Ø-10.0  KR
8	8	2	2	4	8	4	1	1

## XII - XV

 O	 Q	 Y1	8.0x30  D	3.0x13  H1	 BP	Ø-10.0  KR
5	1	2	4	4	2	1

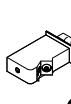

1x

			4.0x30 	8.0x30 	
A	S3	G	H1	D	B
4	16	2	4	8	8

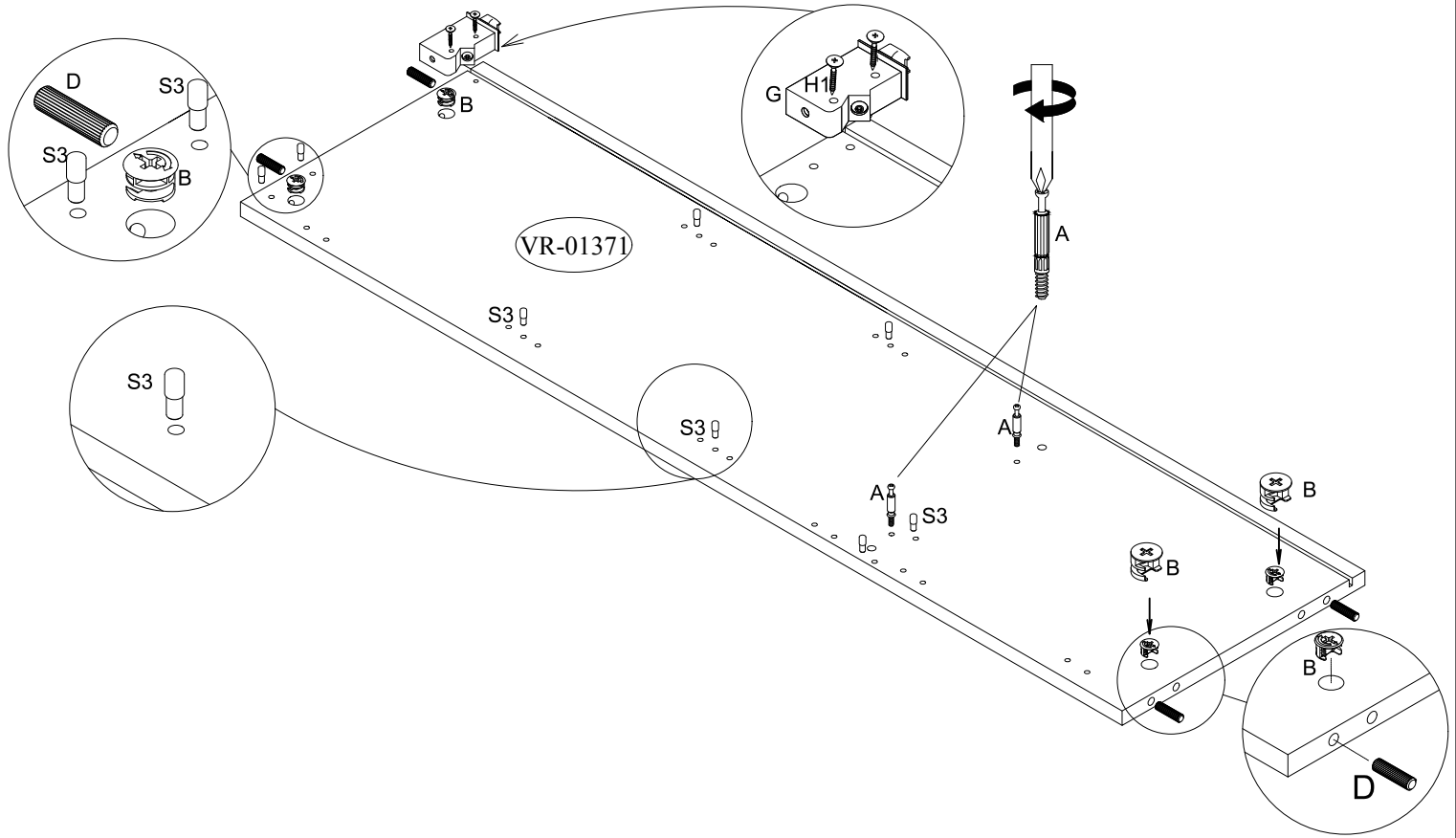

1x

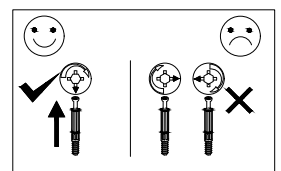
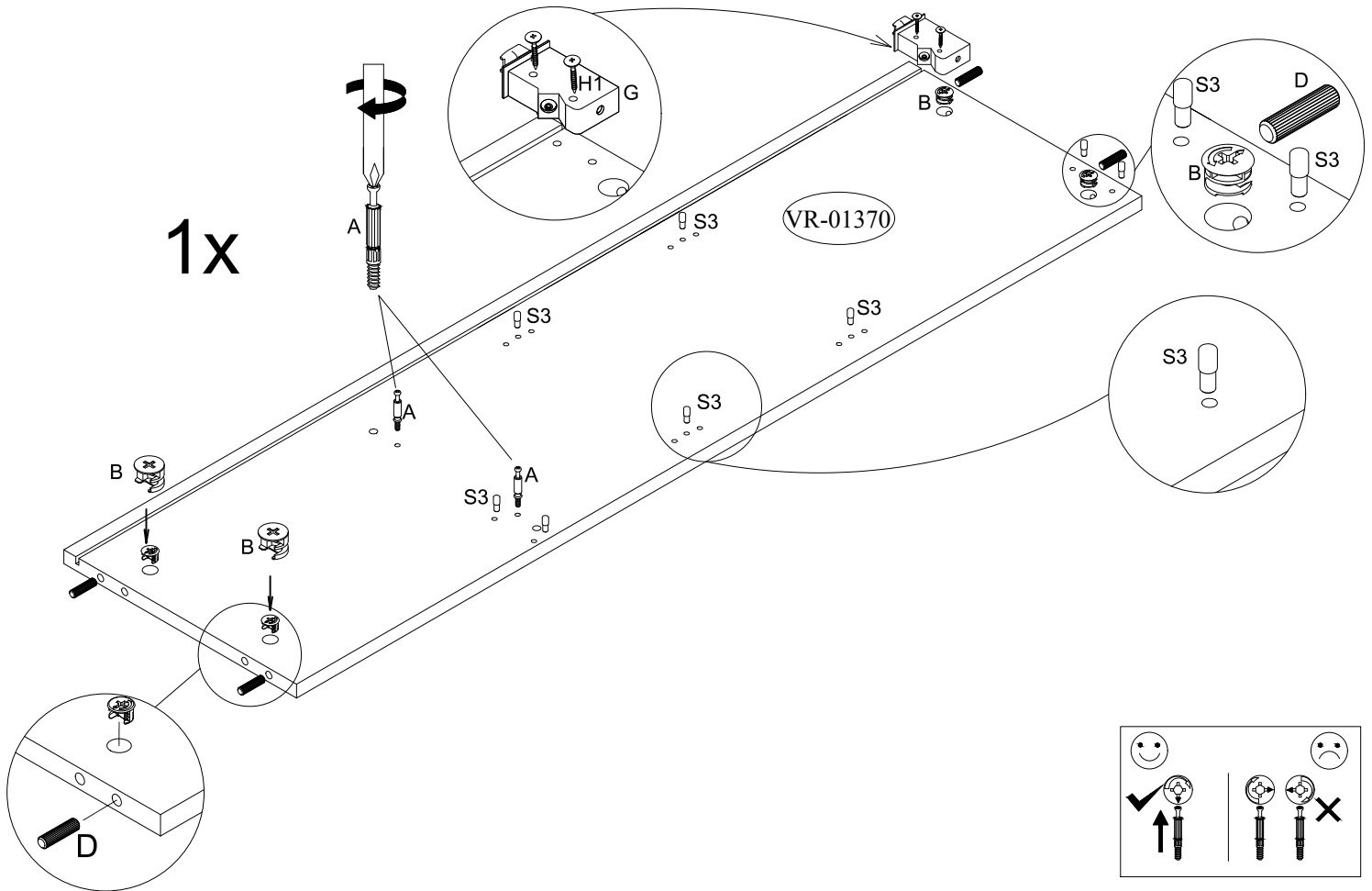

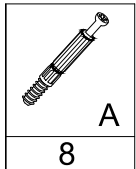
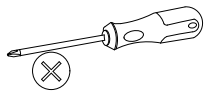
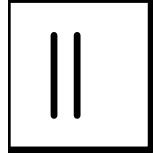

1x

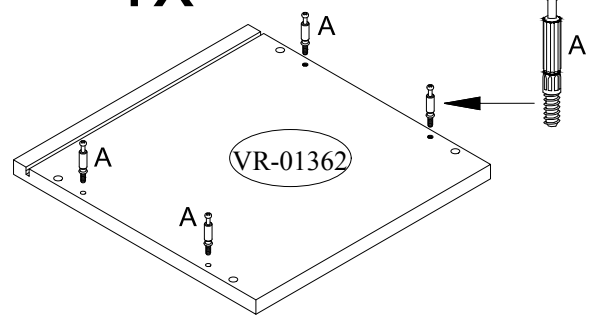

1x

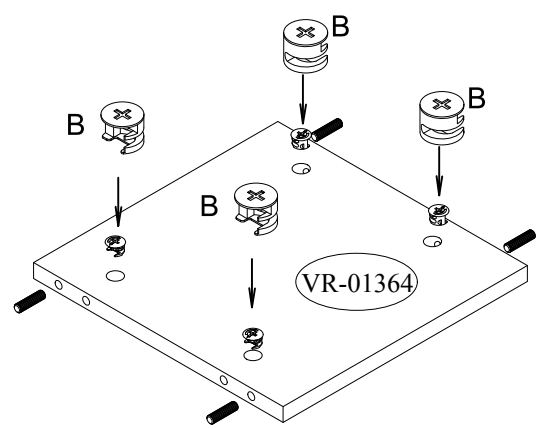
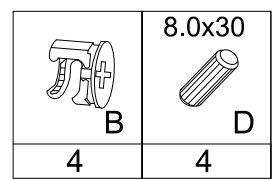
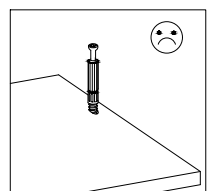
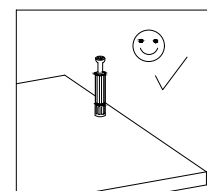
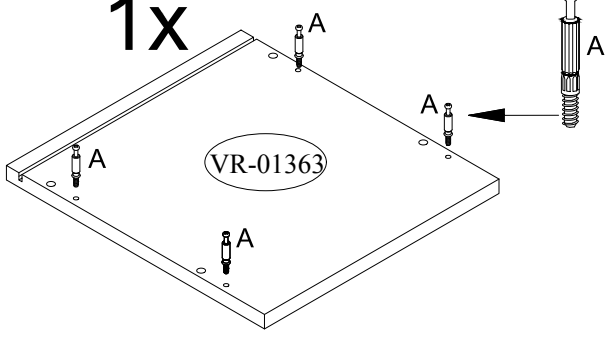

# IV

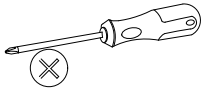

6.3X13		
	F	Z
8		4

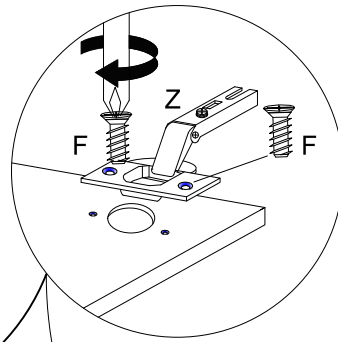

1x

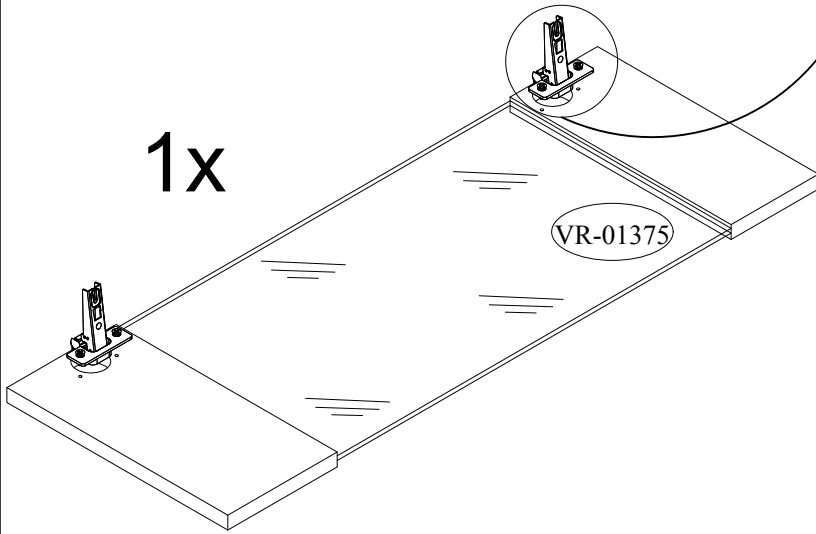

1x

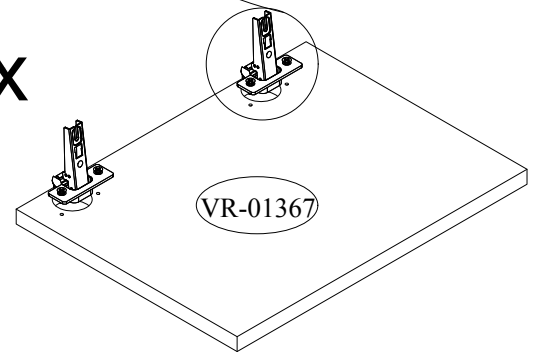

# V

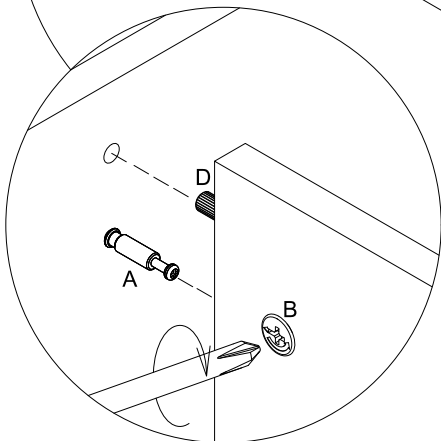
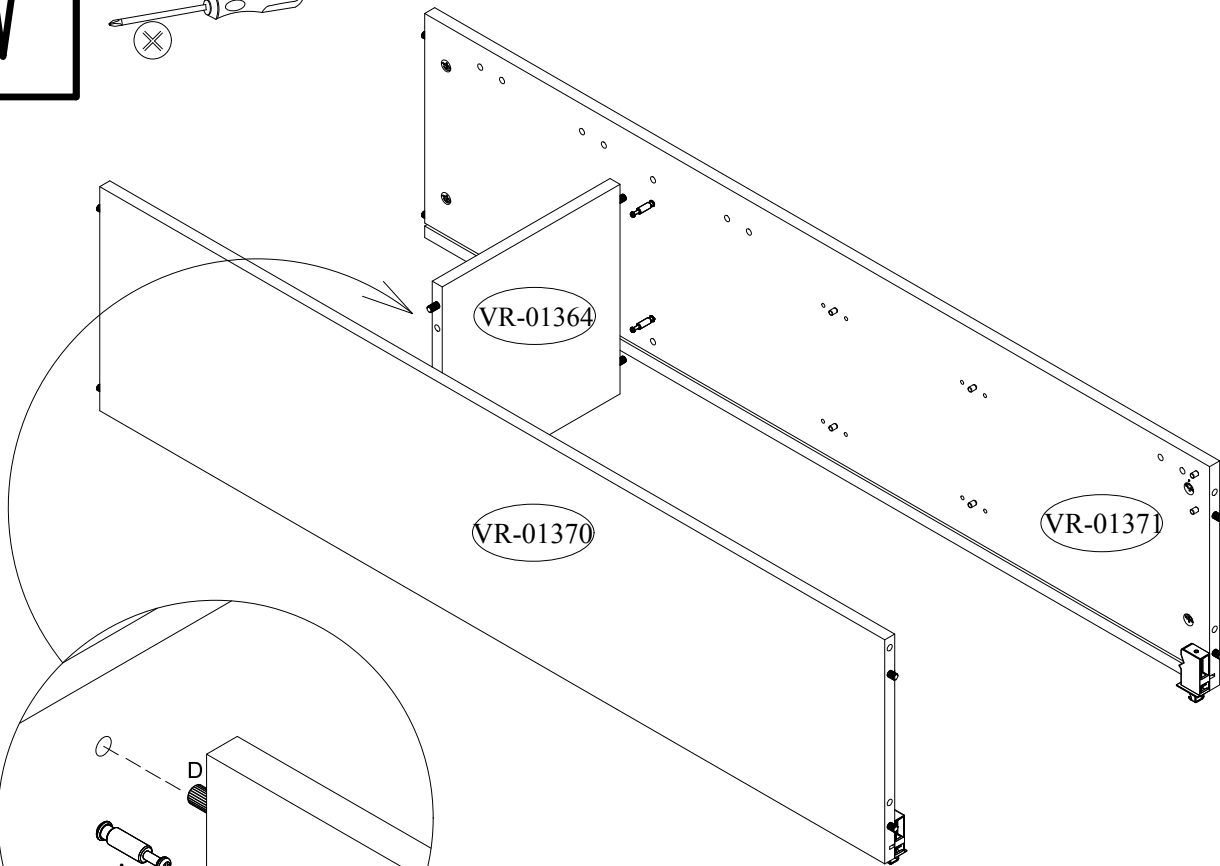
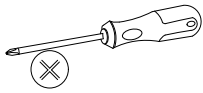

VI

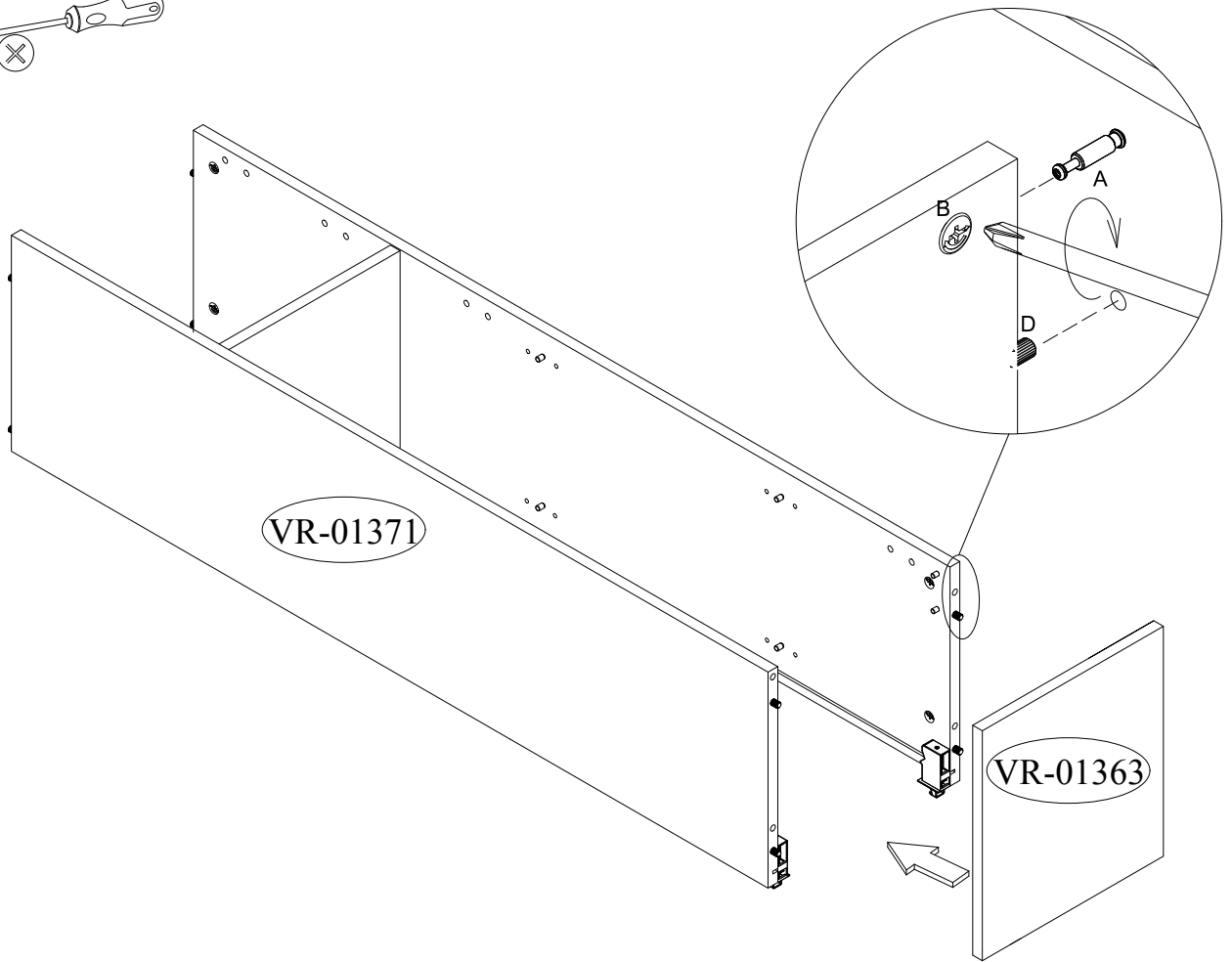
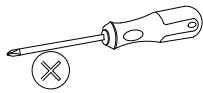

VR-01371

VR-01363

VII

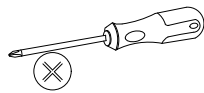

	3.0x13 	
X	H	S4
8	2	2

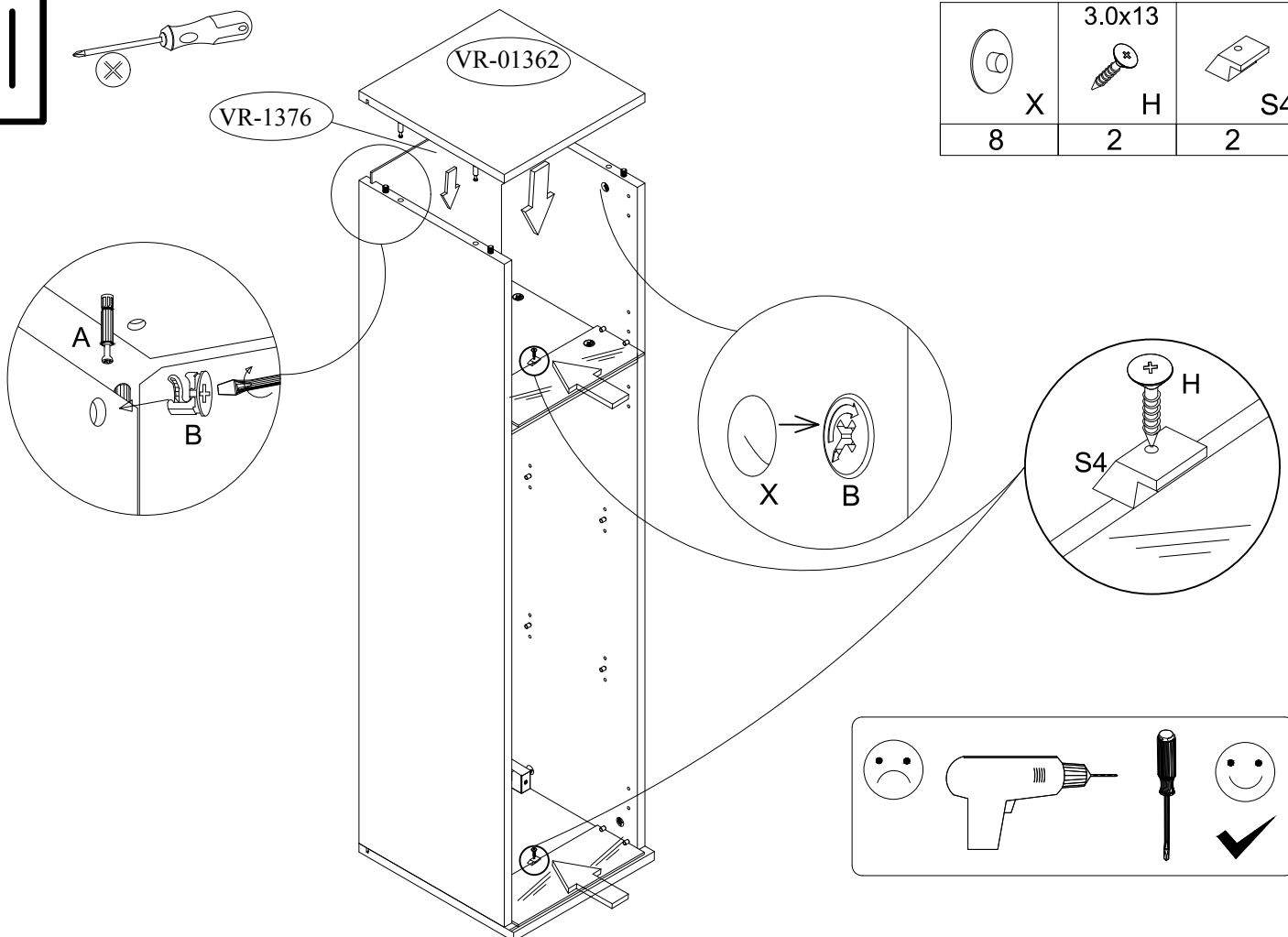

VR-1376

VR-01362

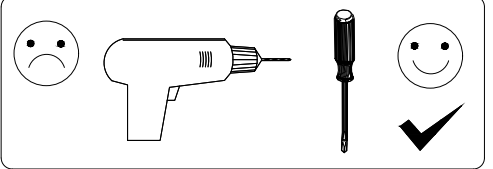
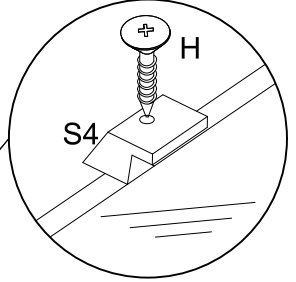
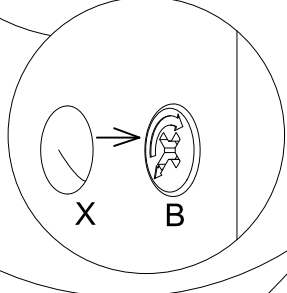
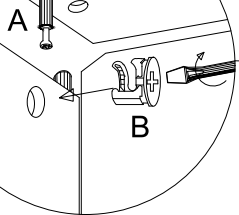



VIII

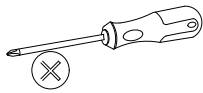

R

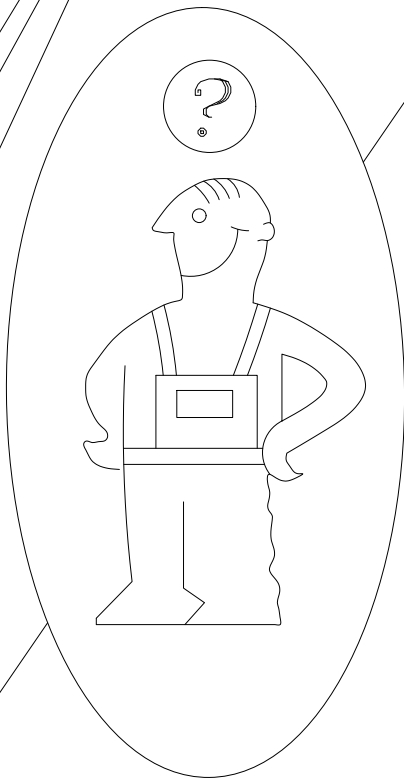
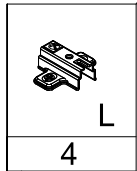
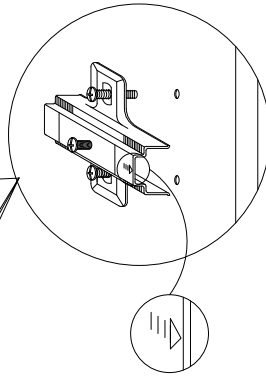
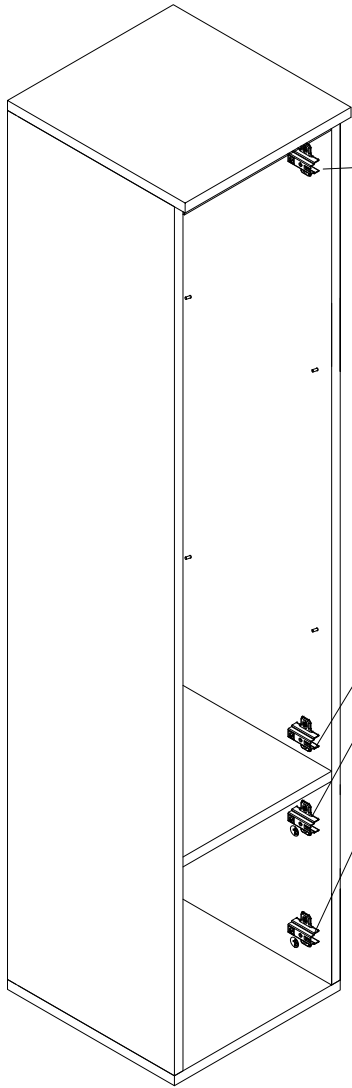

L

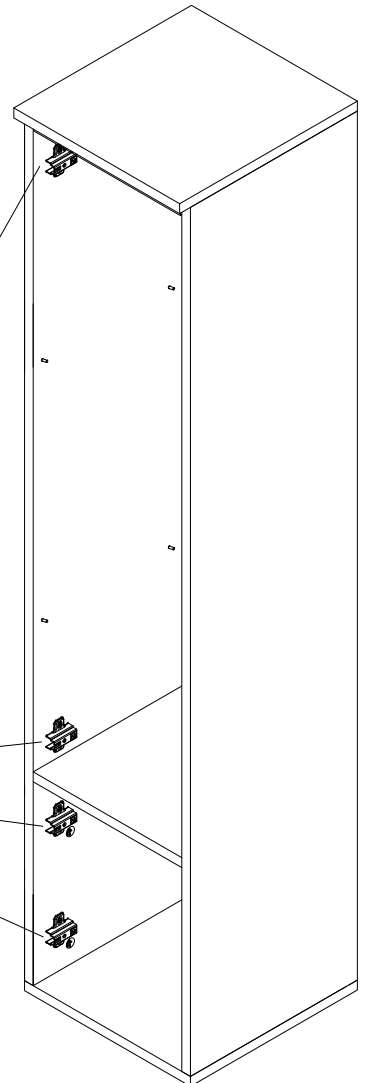
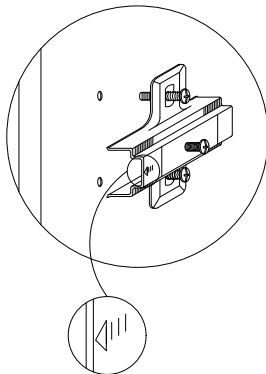

IX

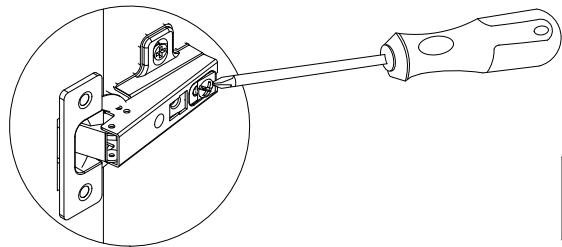
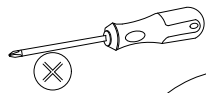

VR-01375

VR-01367

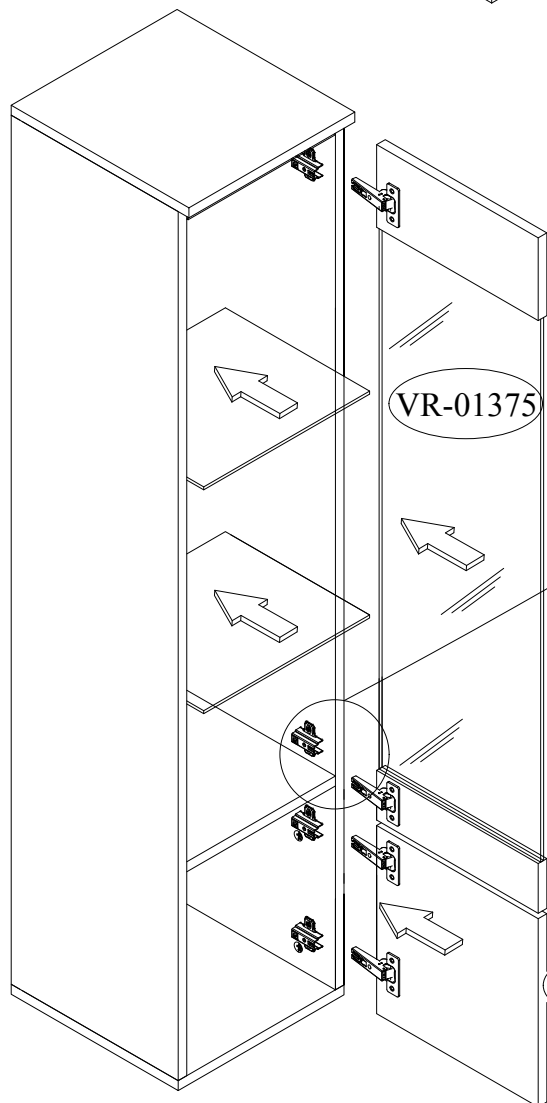
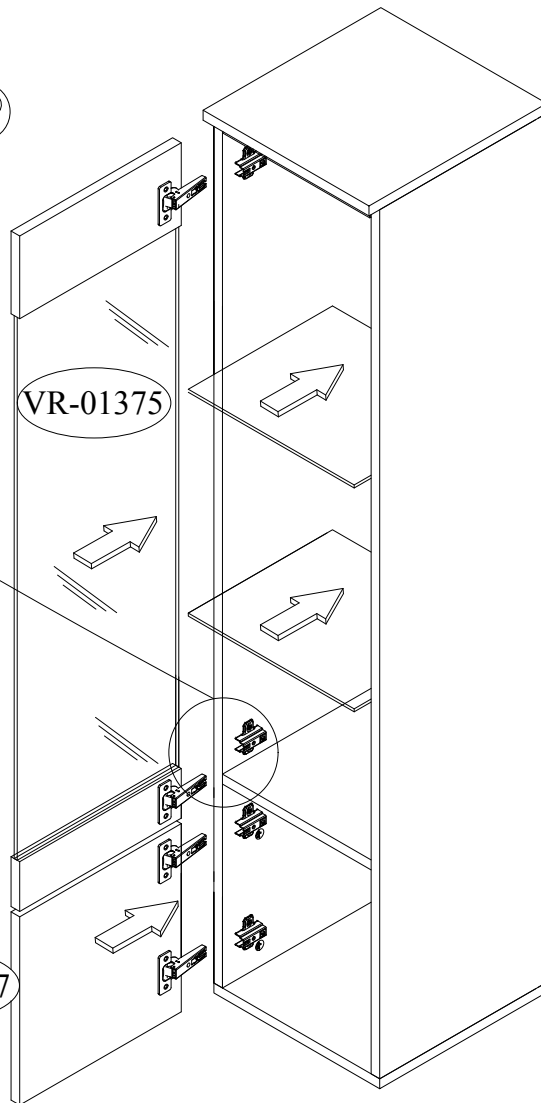

VR-01375

VR-01367

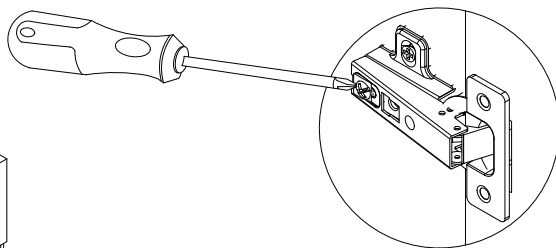

# X

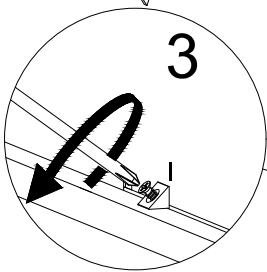
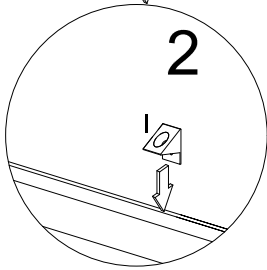
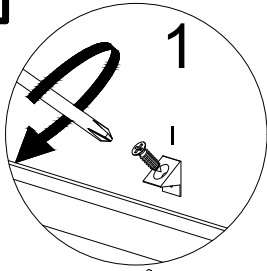
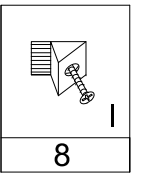
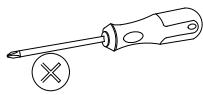

**X=Y**

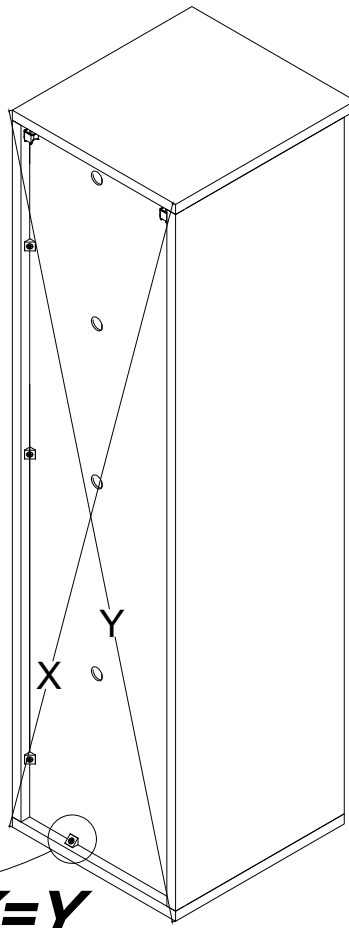

# XI

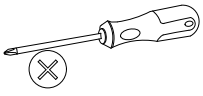

	4.0x25
M	G
4	8

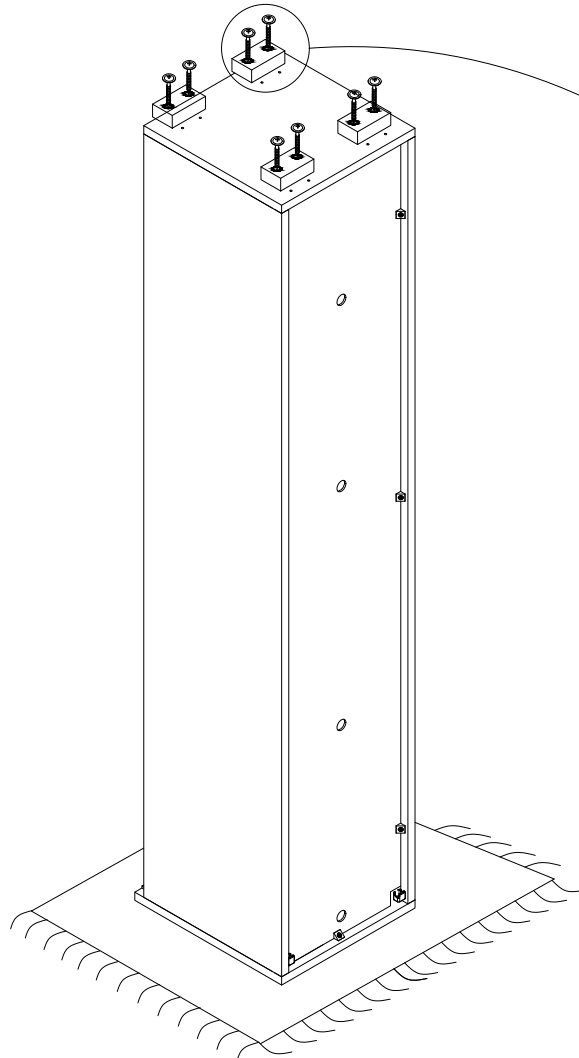
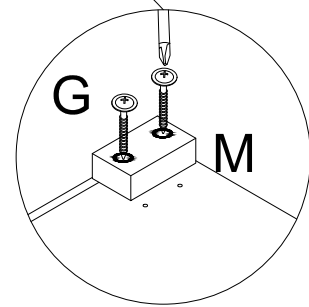

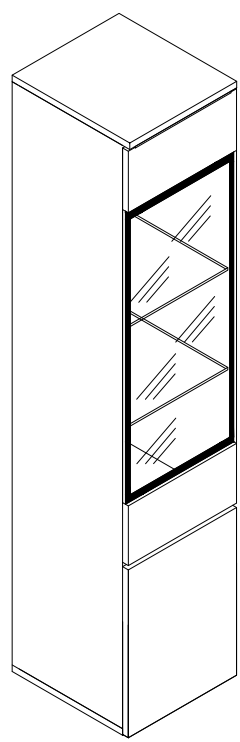
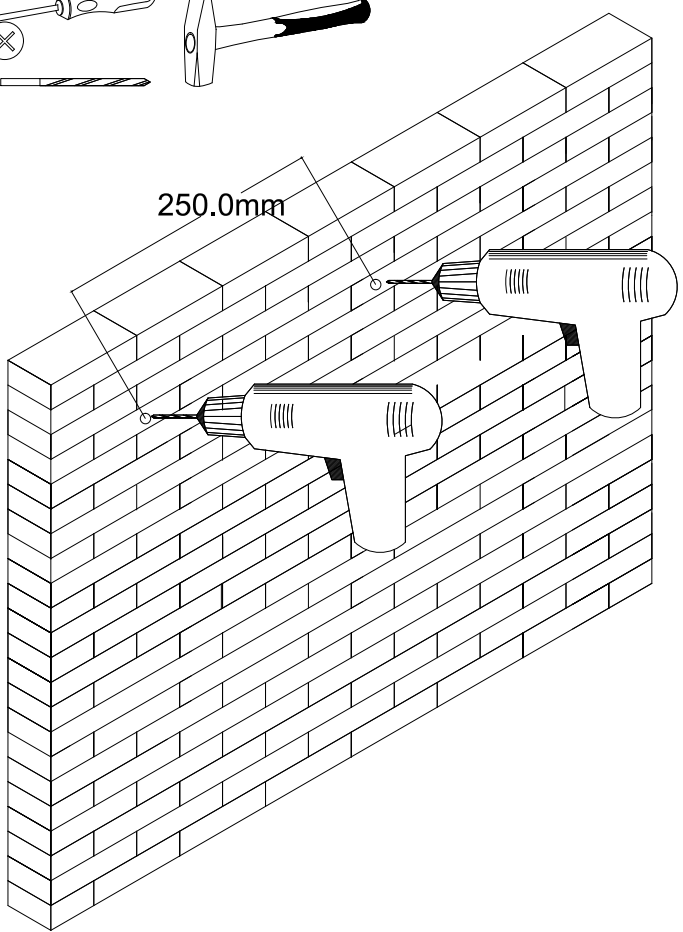
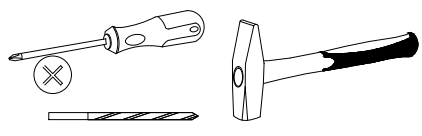
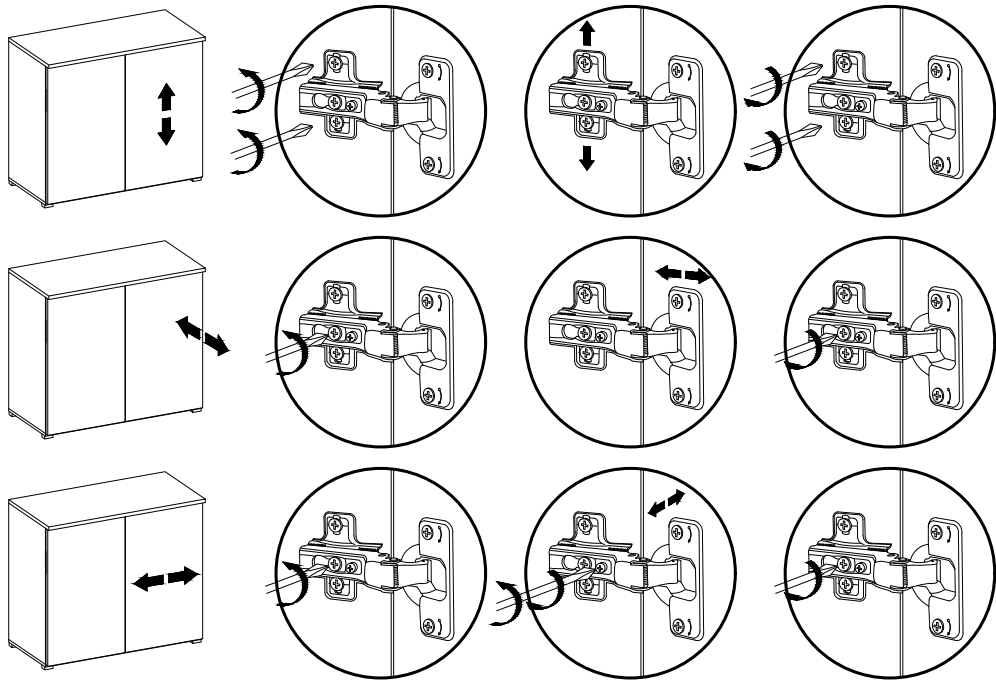

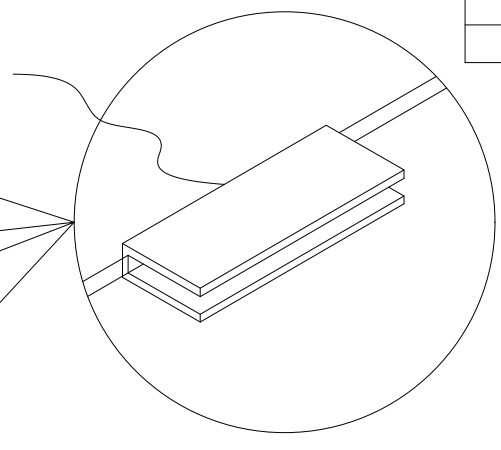
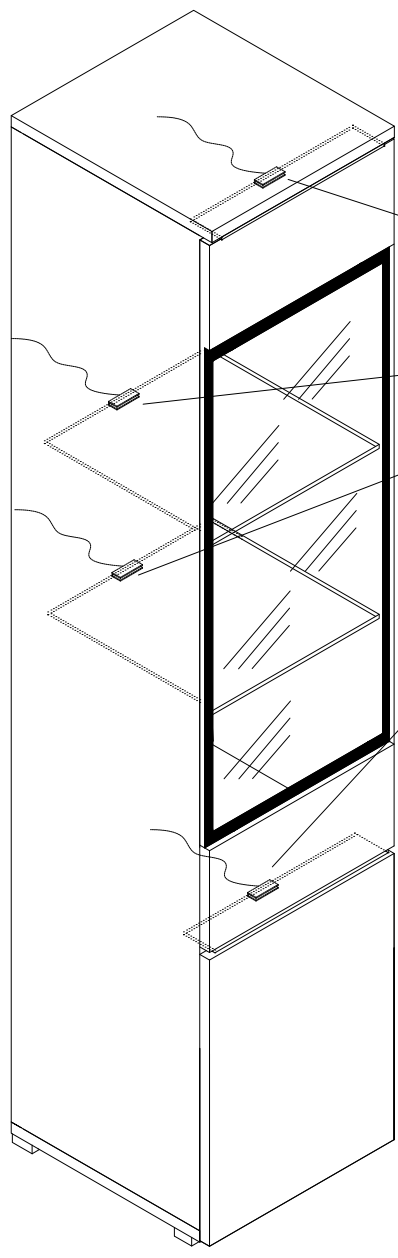
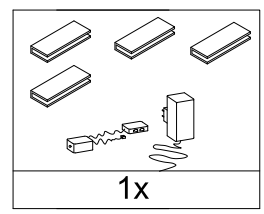

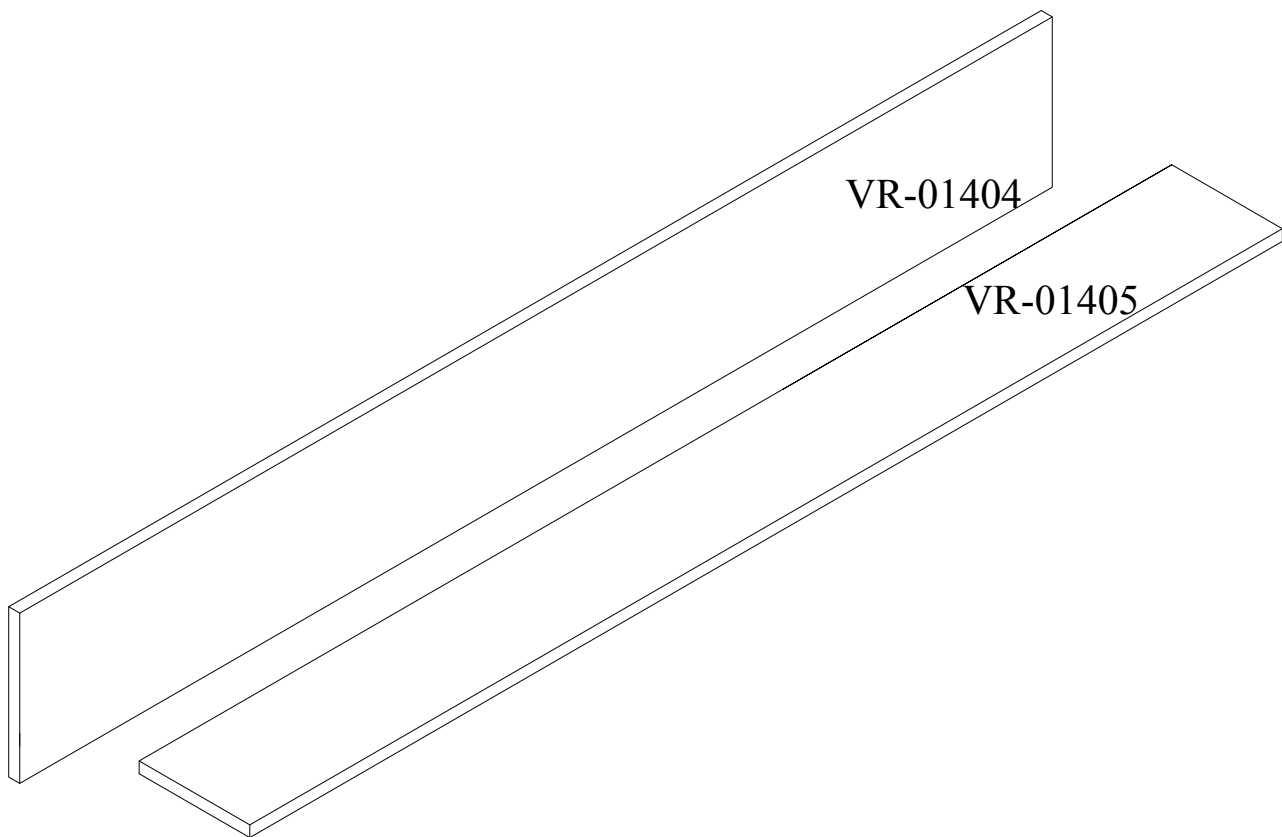

VR-01404

VR-01405

XII

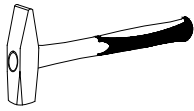

8.0x30



D

4

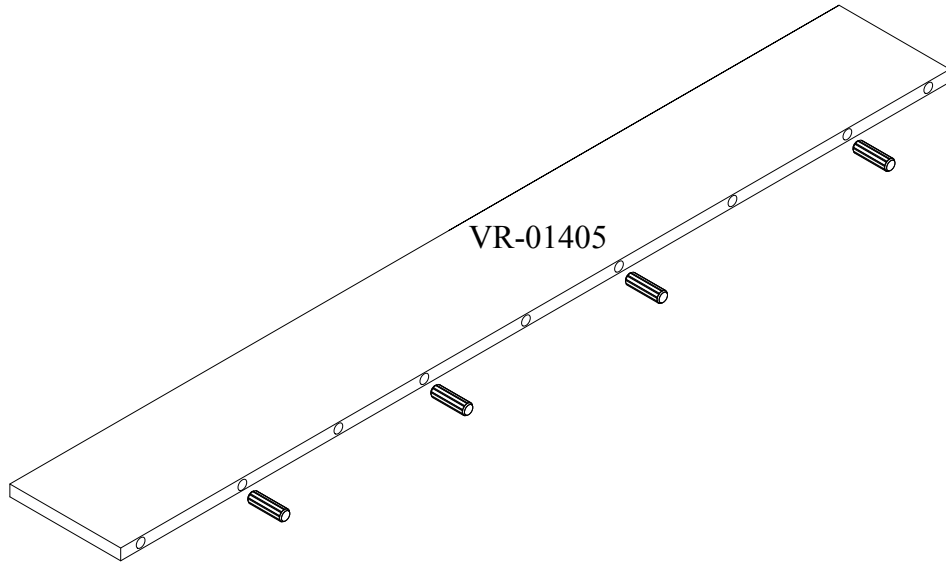

XIII

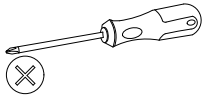

Y1

2



BP

2

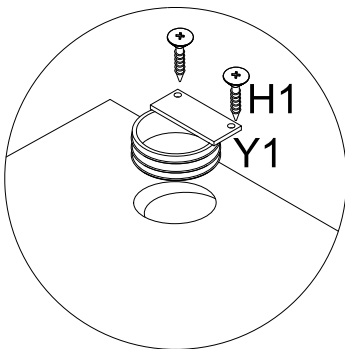
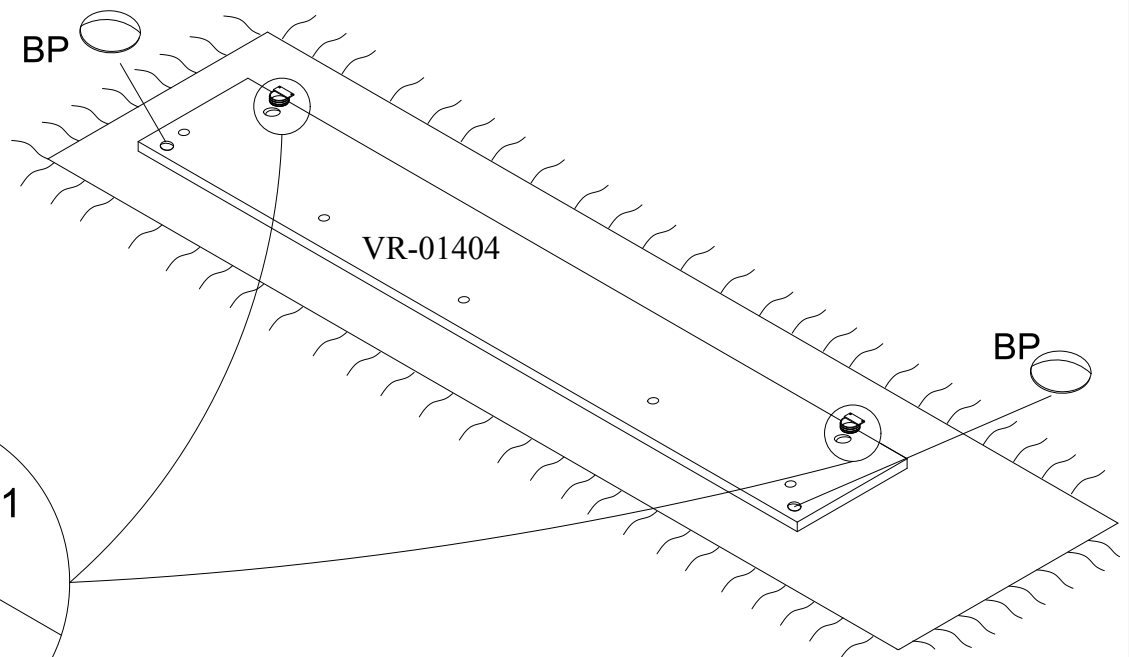

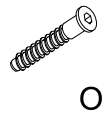

# XIV

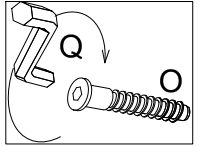
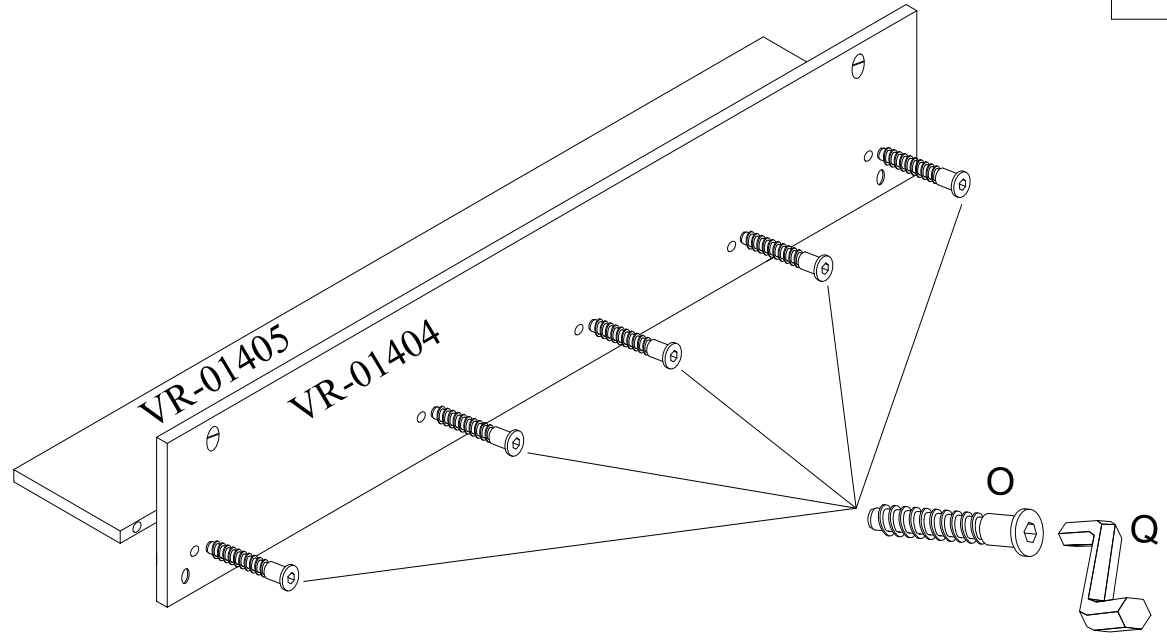
	
Q	O
1	5

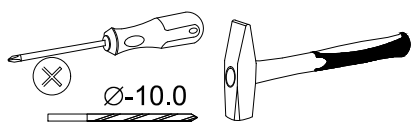

# XV



KR
1

