

60 G-72 1F

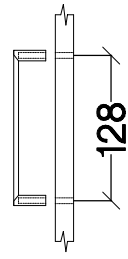

max. 5kg

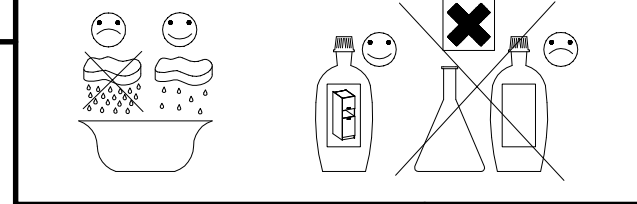

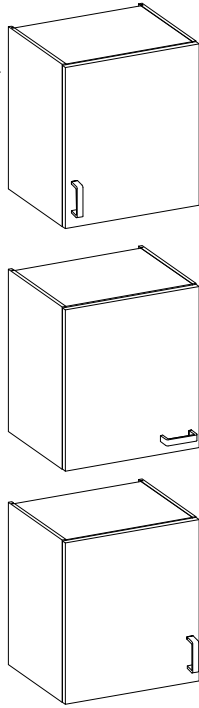
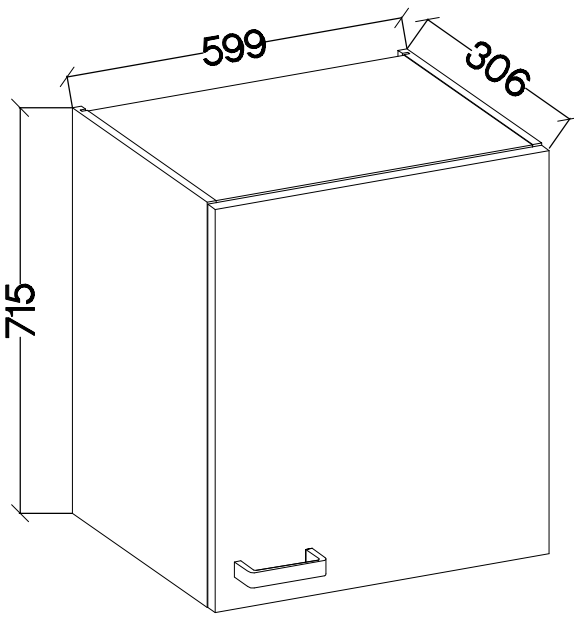
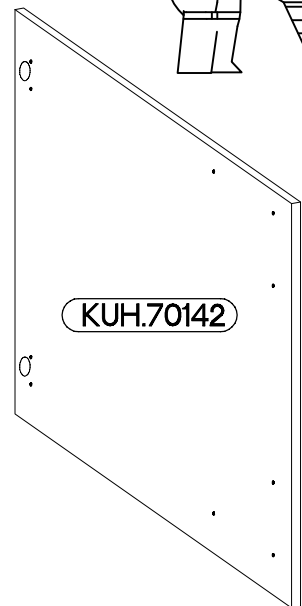
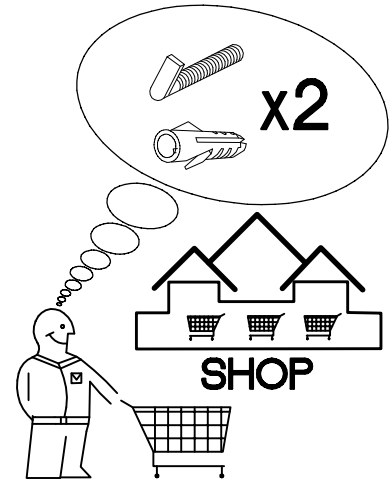
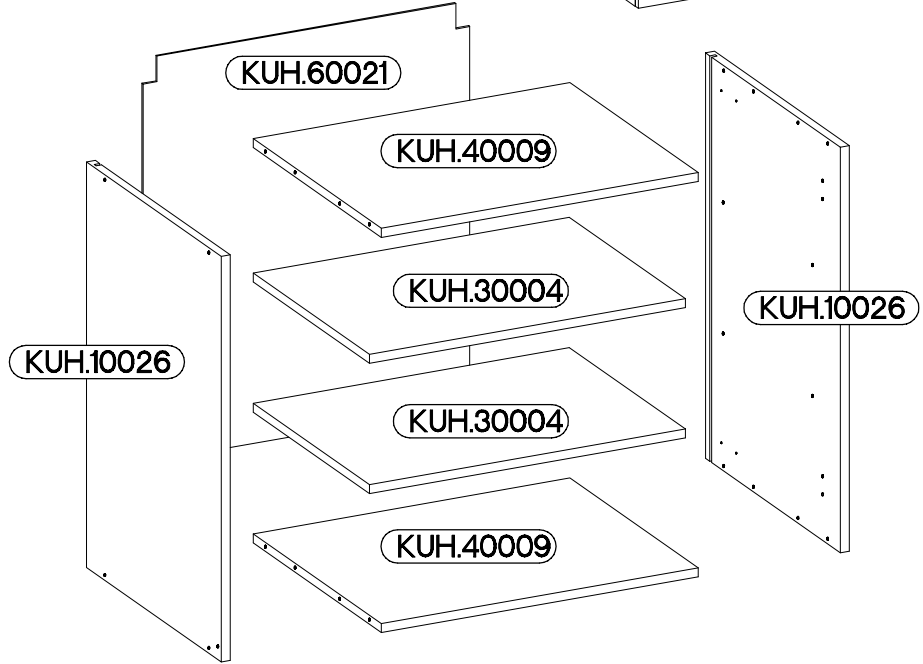
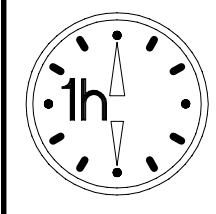

KUH.30004  
KUH.40009

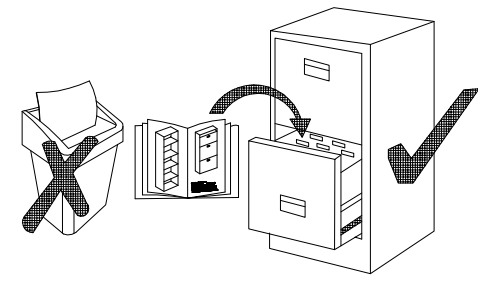

<p>±8x30mm</p> <p>A</p> <p>8</p>	<p>6,4 x 50mm</p> <p>B</p> <p>8</p>	<p>E1</p> <p>8</p>	<p>±35/0mm</p> <p>HG</p> <p>2</p>	<p>±5/19mm</p> <p>J</p> <p>8</p>	<p>K</p> <p>2</p>
<p>O</p> <p>1</p>	<p>±3.5x13mm</p> <p>P5</p> <p>4</p>	<p>±3.0x20mm</p> <p>P7</p> <p>8-10</p>	<p>±4.0x30mm</p> <p>P8</p> <p>4</p>	<p>M4x22mm</p> <p>U</p> <p>2</p>	<p>S23</p> <p>1</p>

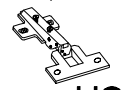

ISM-KUH-00932

±8x30mm	±35/0mm	±3.5x13mm	±4.0x30mm	
				
A	HG	P5	P8	K
8	2	4	4	2

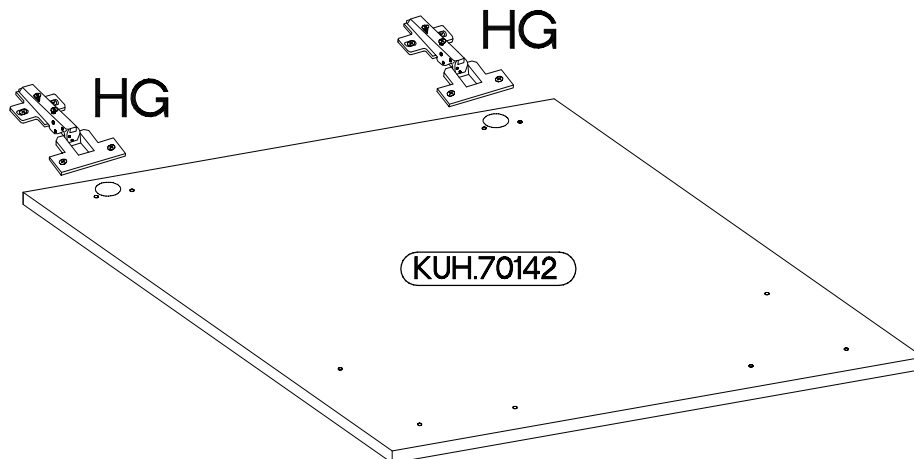
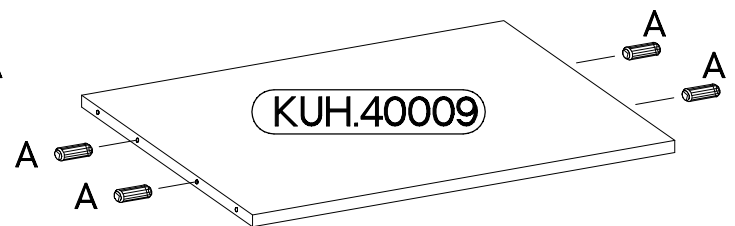
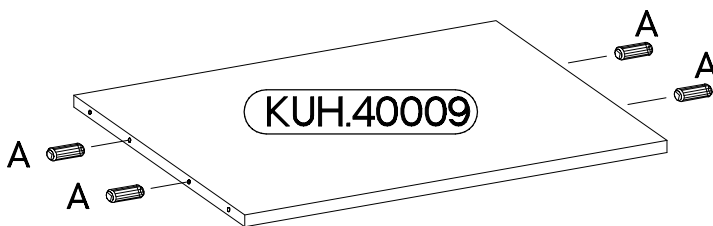
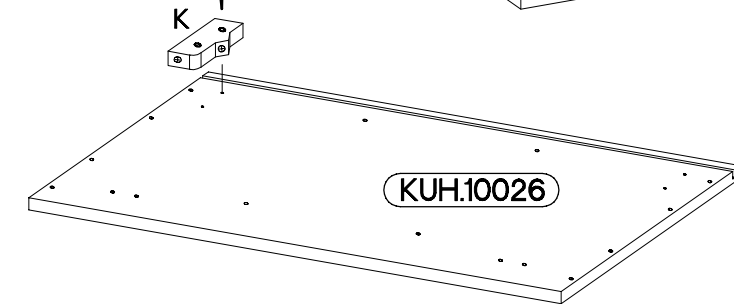
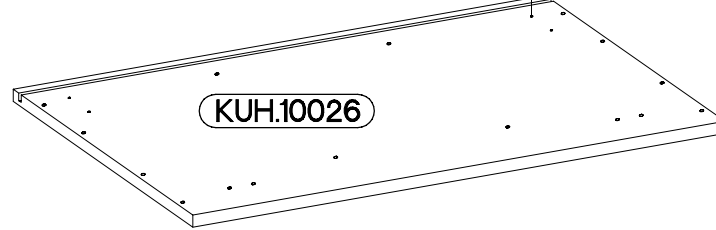
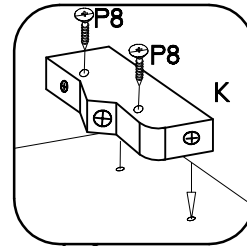
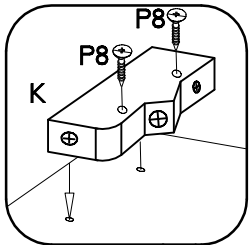
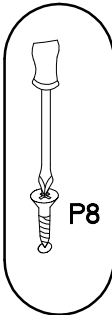
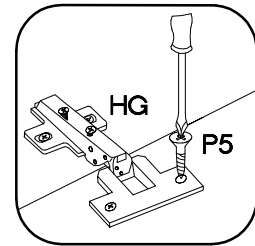
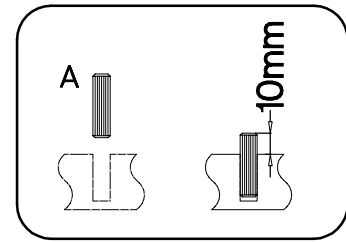
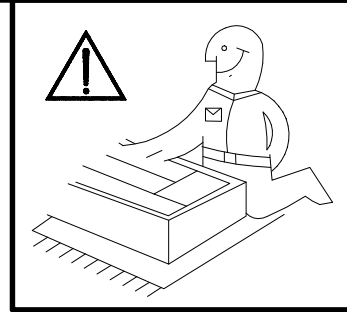

# 2

6,4 x 50mm

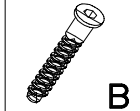

4

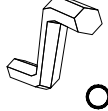

1



4

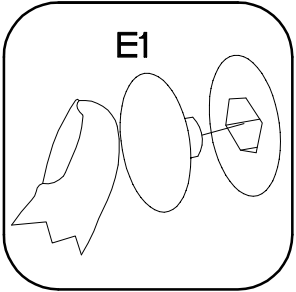
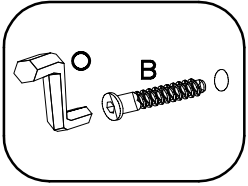
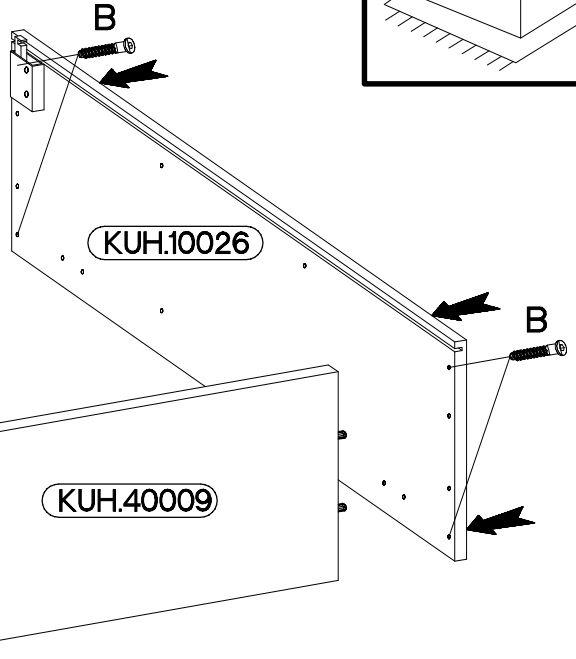
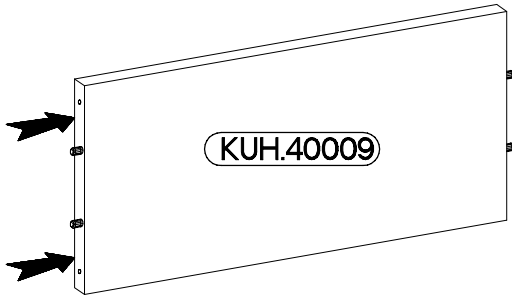
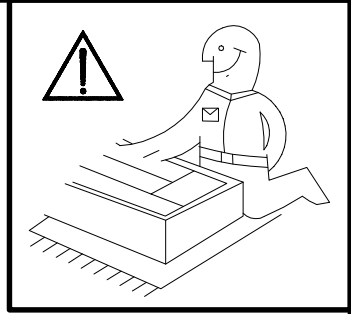

# 3

6,4 x 50mm

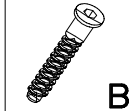

4

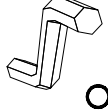

1



4

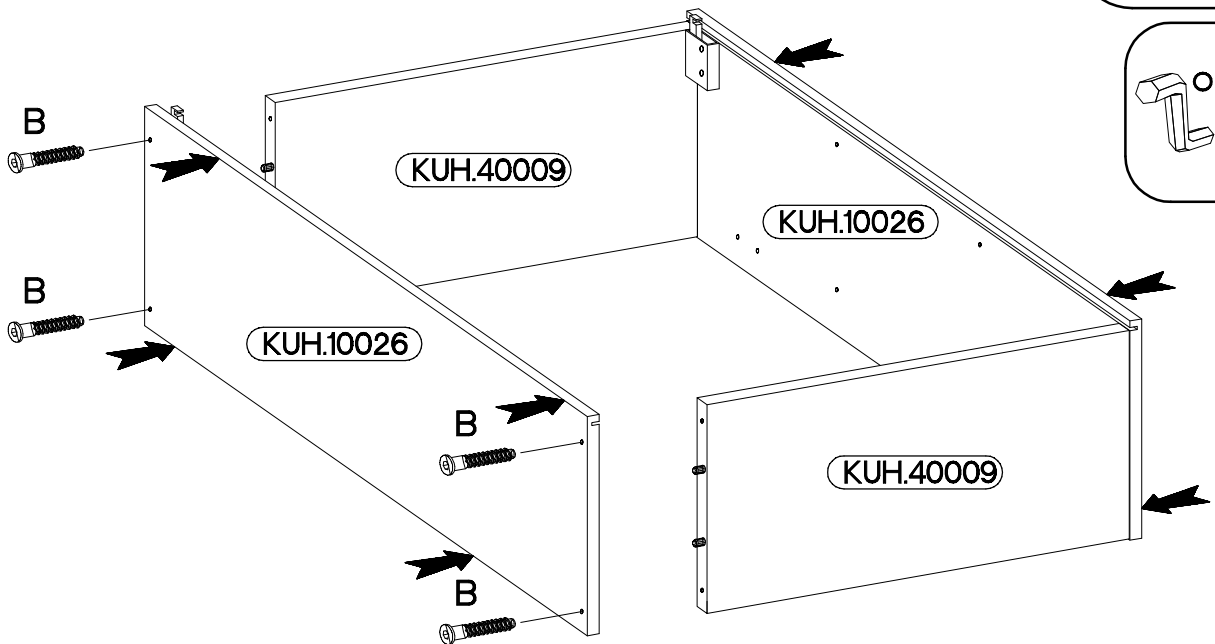
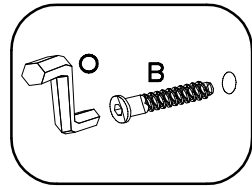
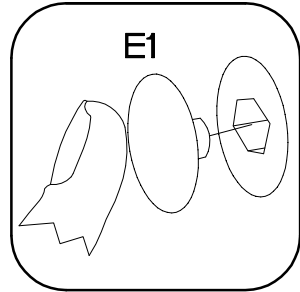



6

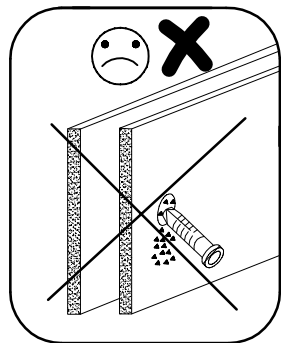
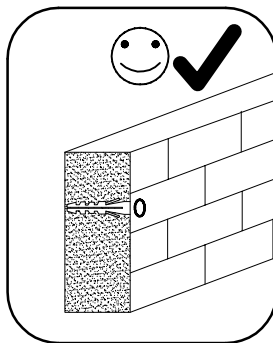
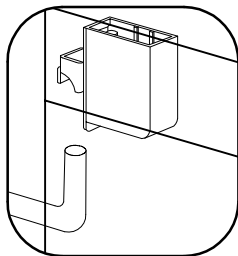
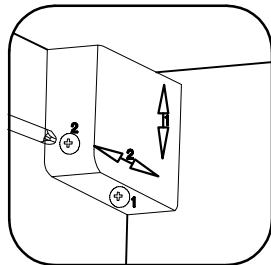
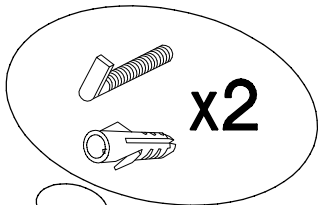
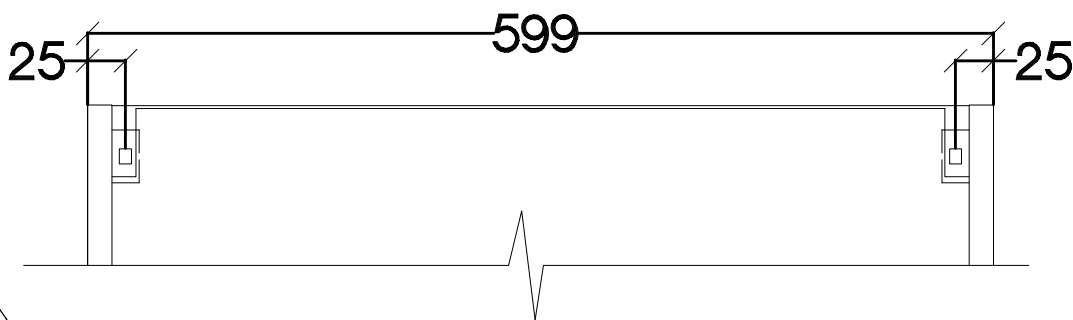
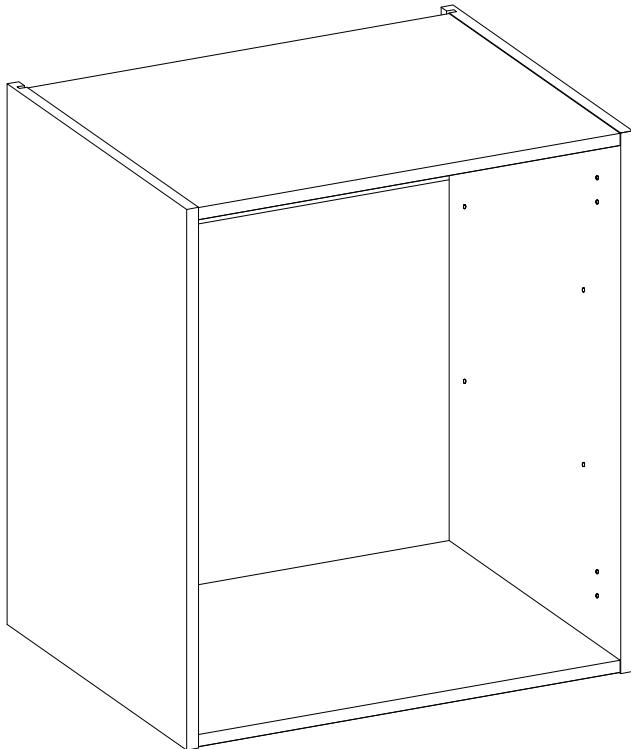
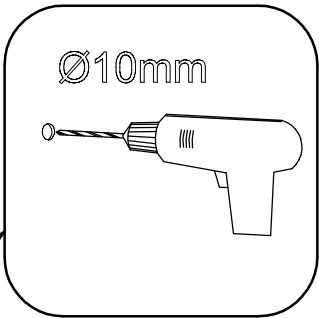
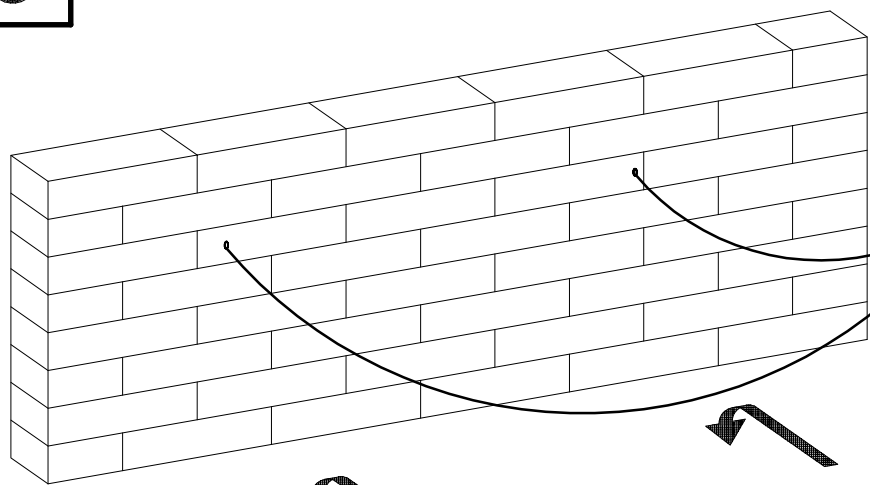

7

+5/19mm  
J  
8

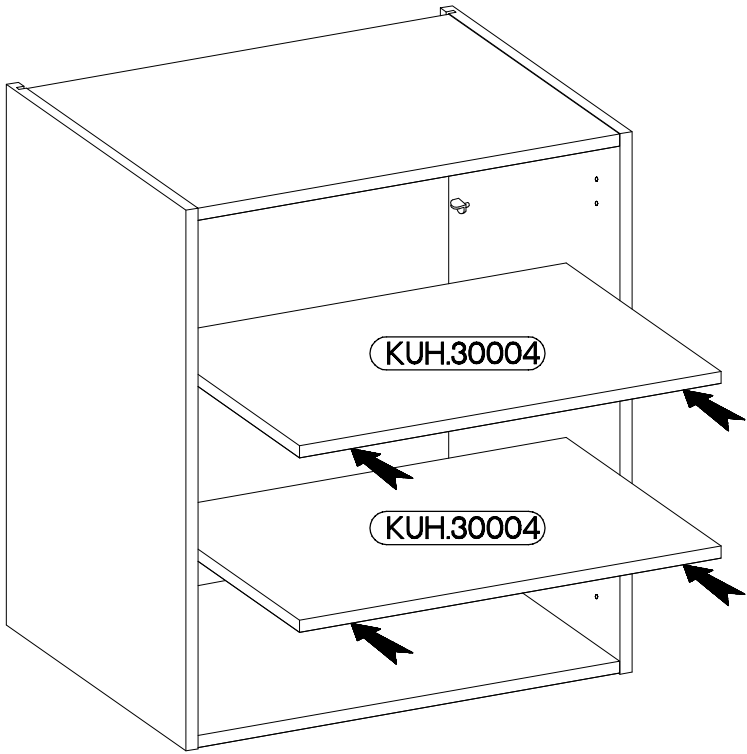
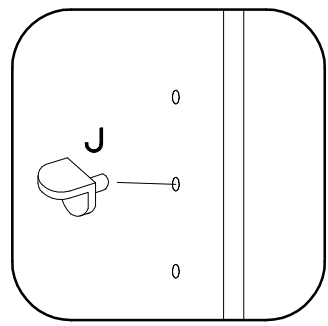

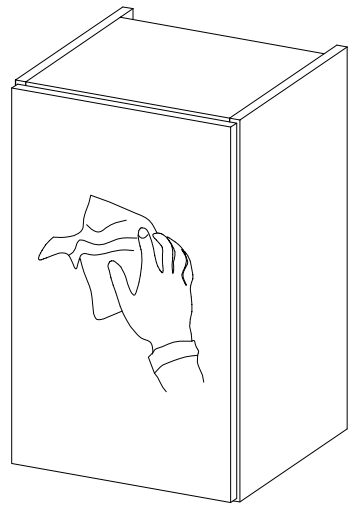
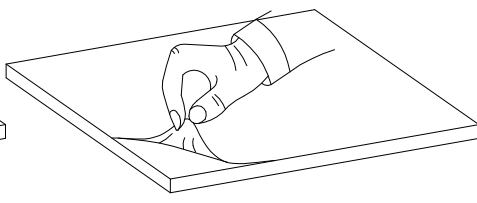
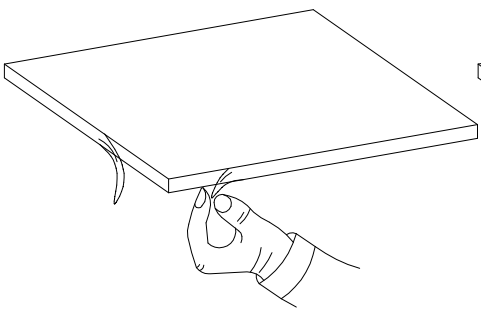
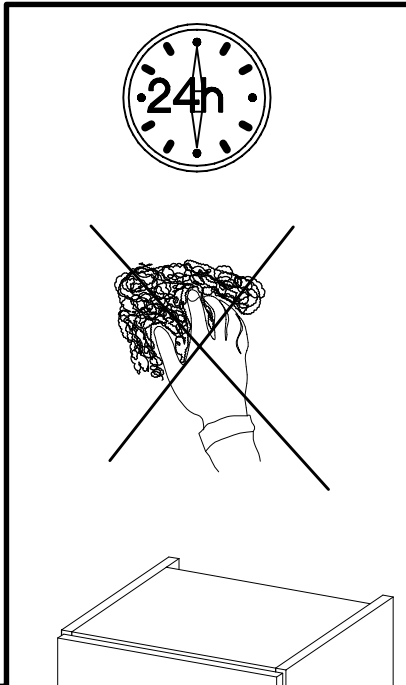
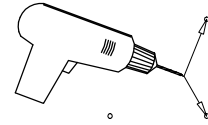
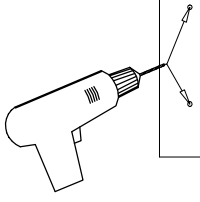
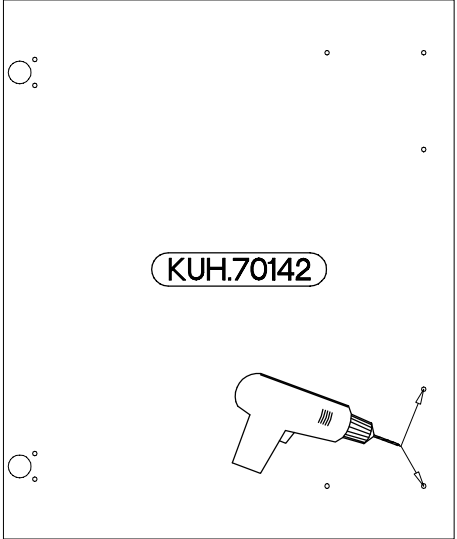
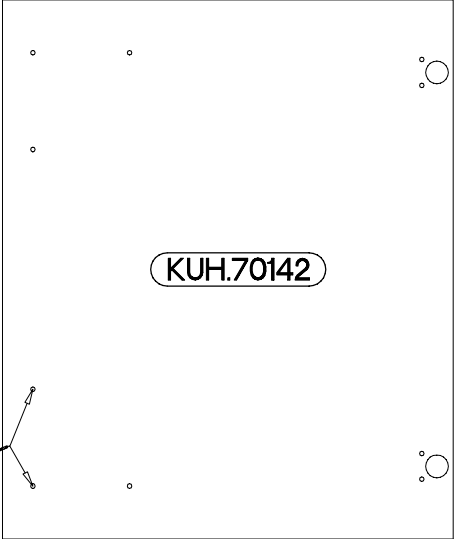
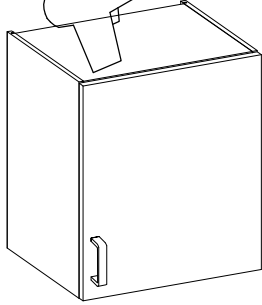
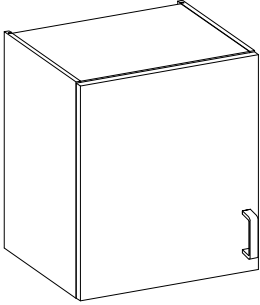
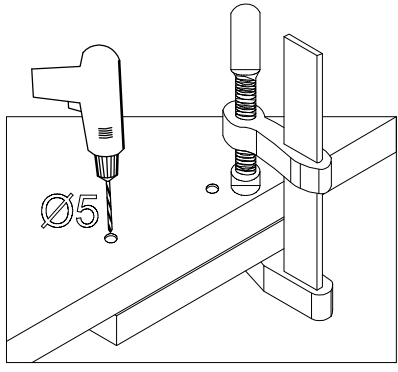
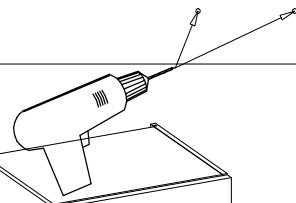
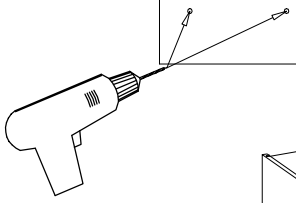
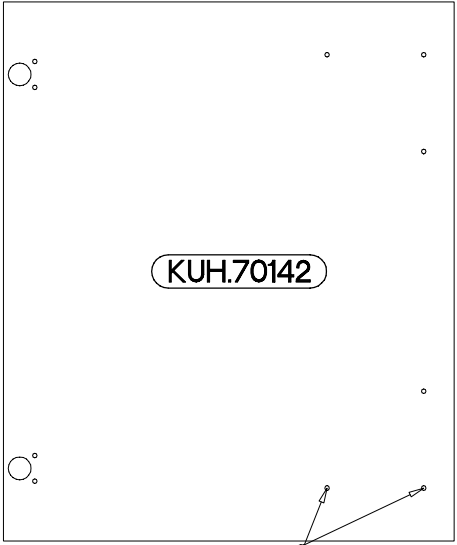
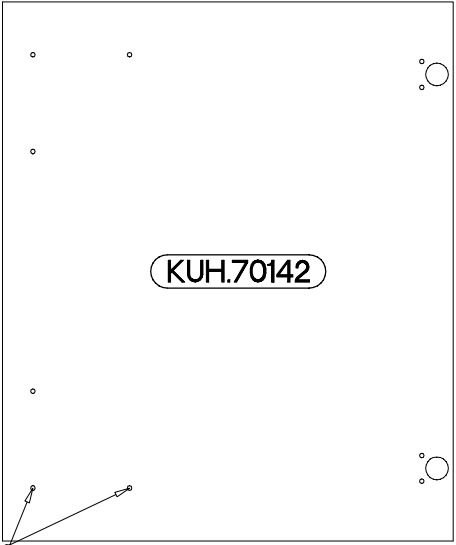
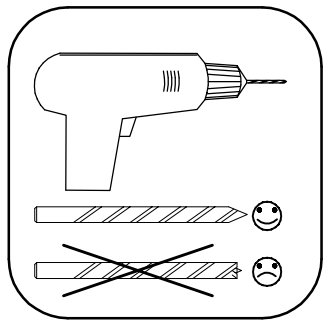
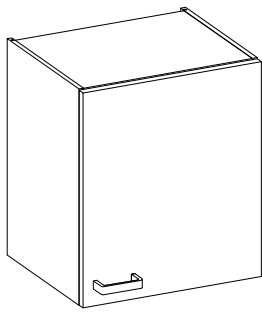
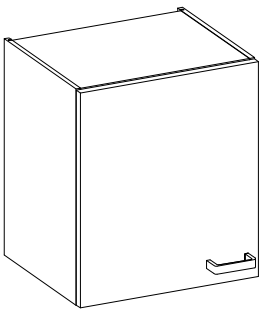

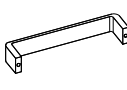
M4x22mm		
	U	S23
2		1

