

**40 DK-2100 2F**

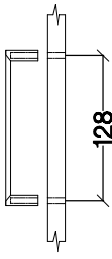

max.  
5kg

KUH.30009  
KUH.40025  
KUH.40026

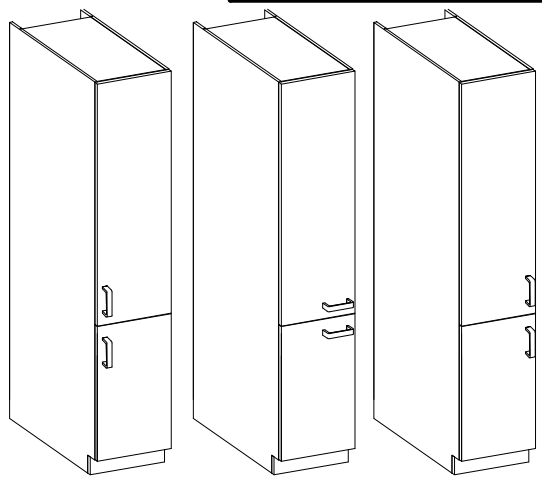
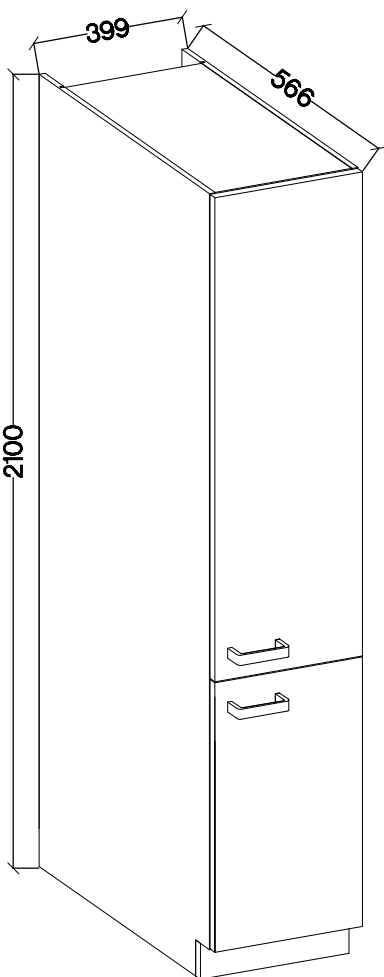
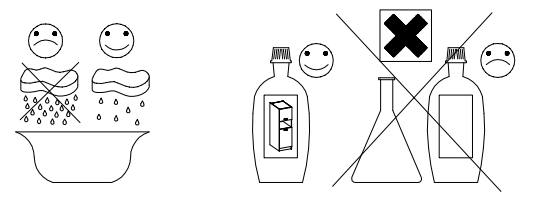
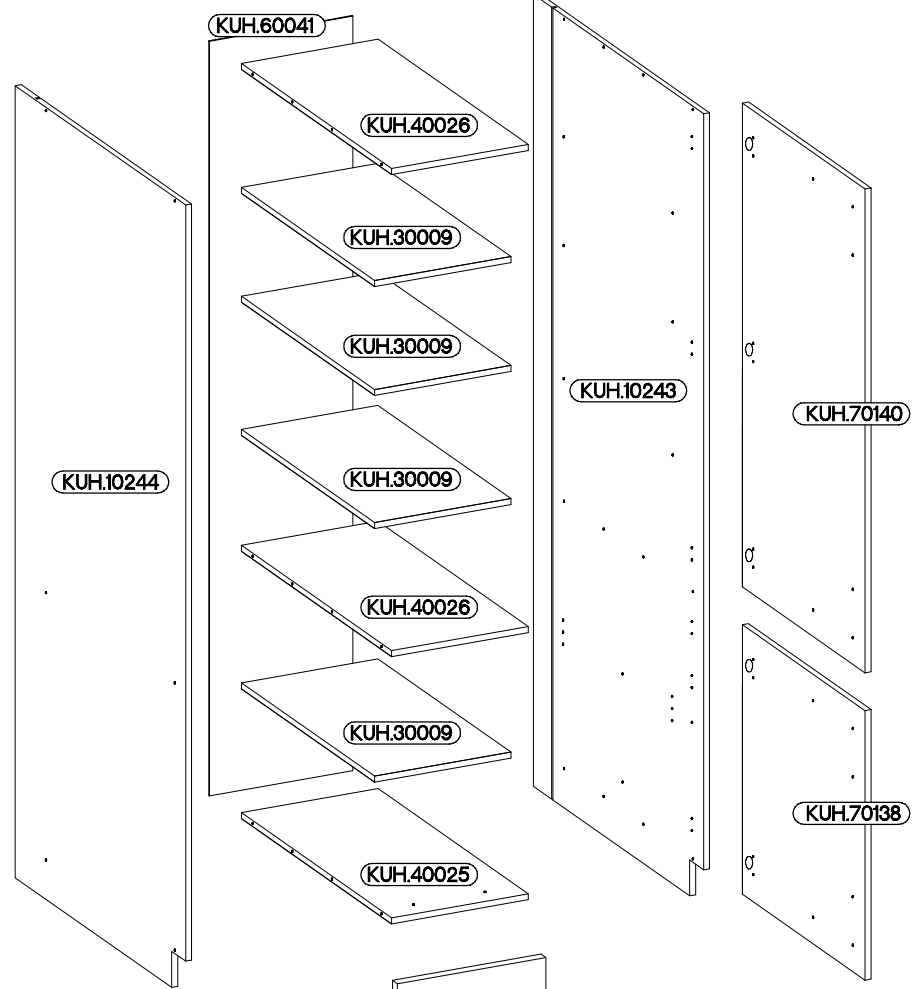
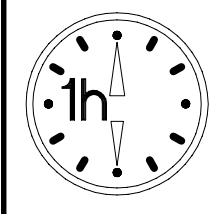



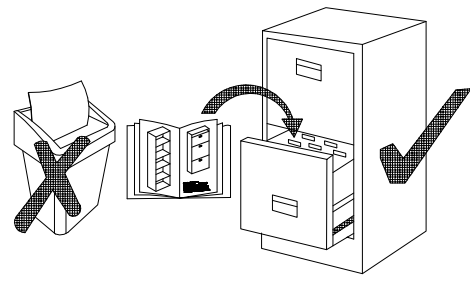

(KUH.90039)

+8x30mm  A 12	6,4 x 50mm  B 12	 E1 12	 E9 2	6.5x48x16  F2 4	+35/0mm  HG 5	+5/19mm  J 16
 L25 1	 O 1	+4.0x45mm  P4 2	+3.5x13mm  P5 12	+3.0x20mm  P7 10-15	 S23 2	M4x22mm  U 4



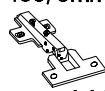

# 1

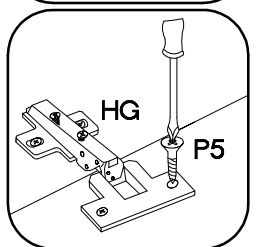
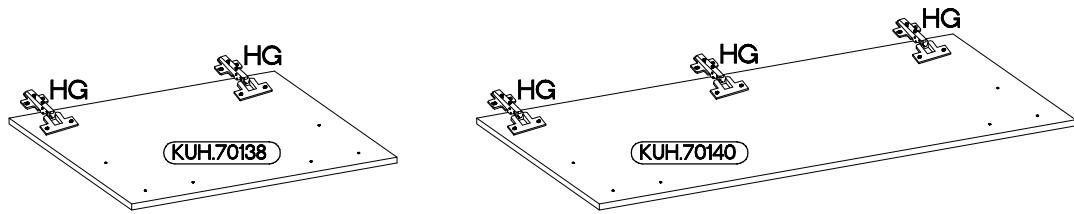
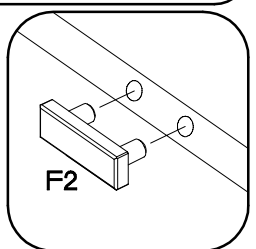
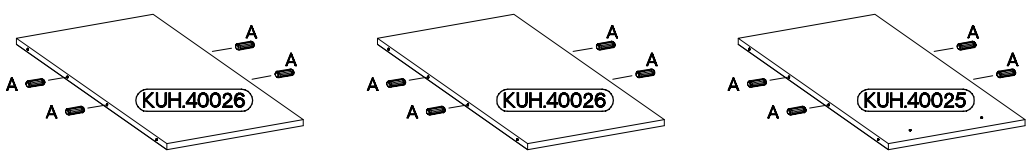
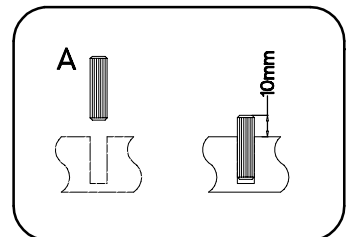
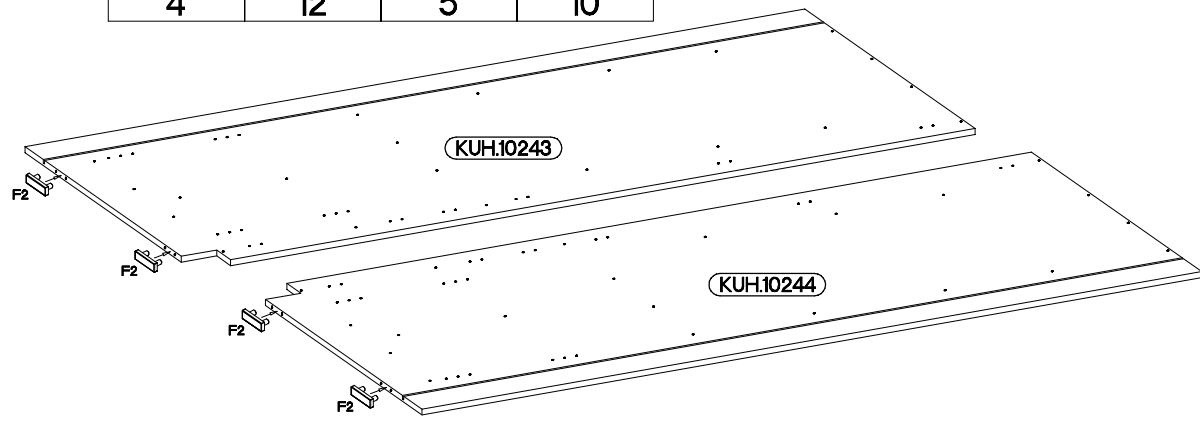
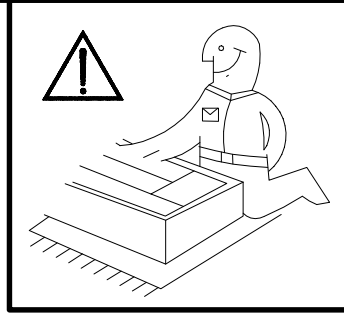
6.5x48x16	+8x30mm	+35/0mm	+3.5x13mm
			
F2	A	HG	P5
4	12	5	10

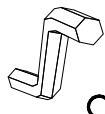

# 2

6,4 x 50mm			
	B	O	E1
	6	1	6

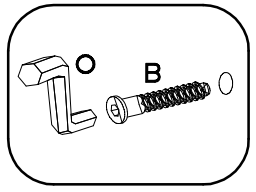
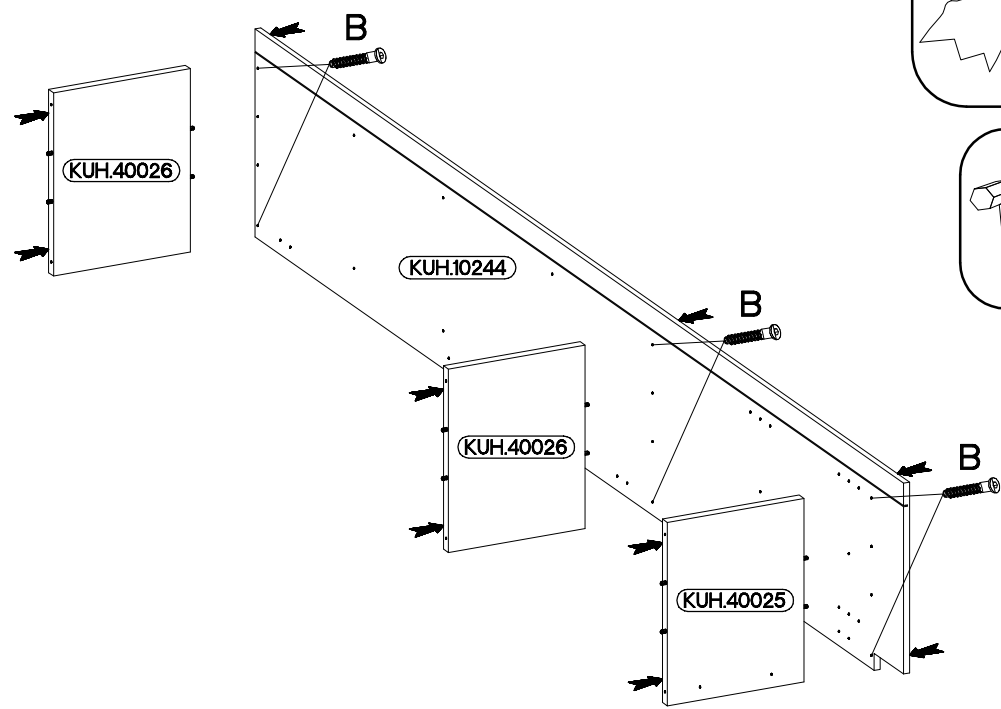
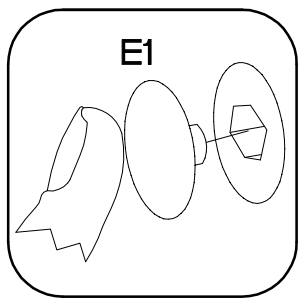

3

6,4 x 50mm

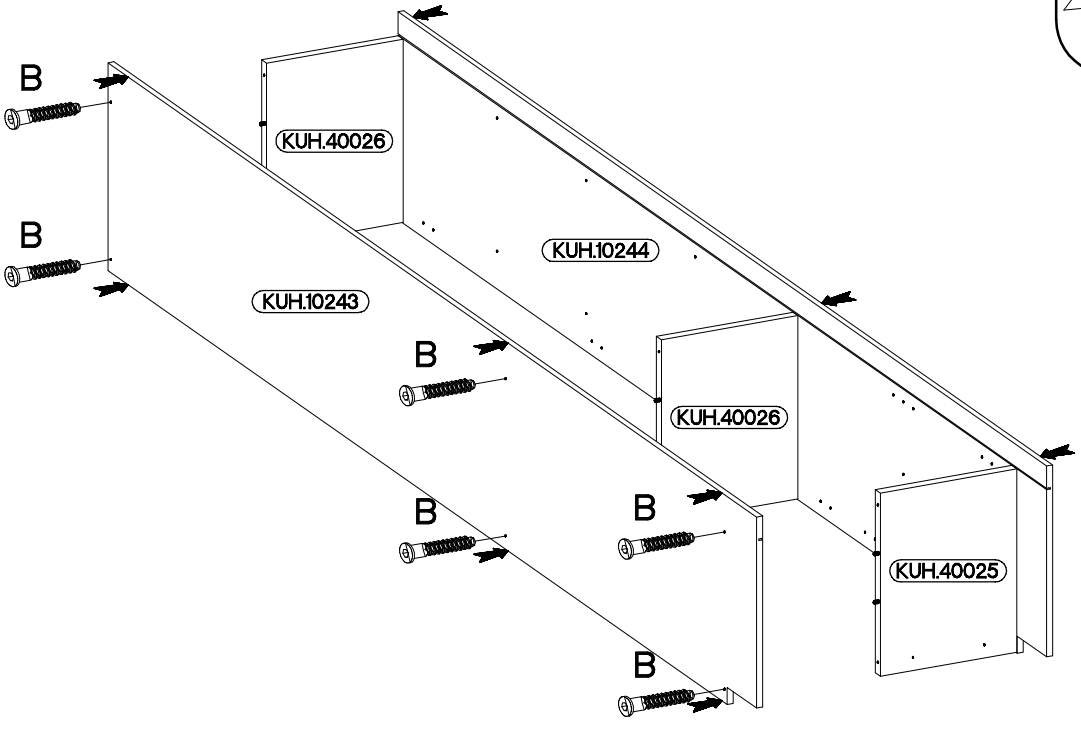
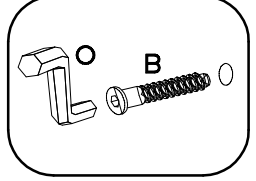
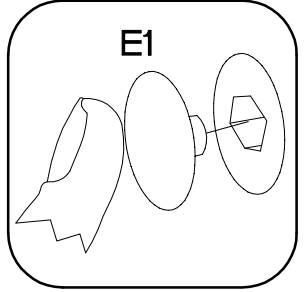
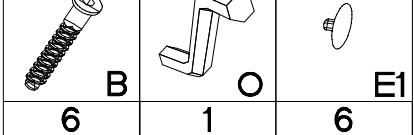

4

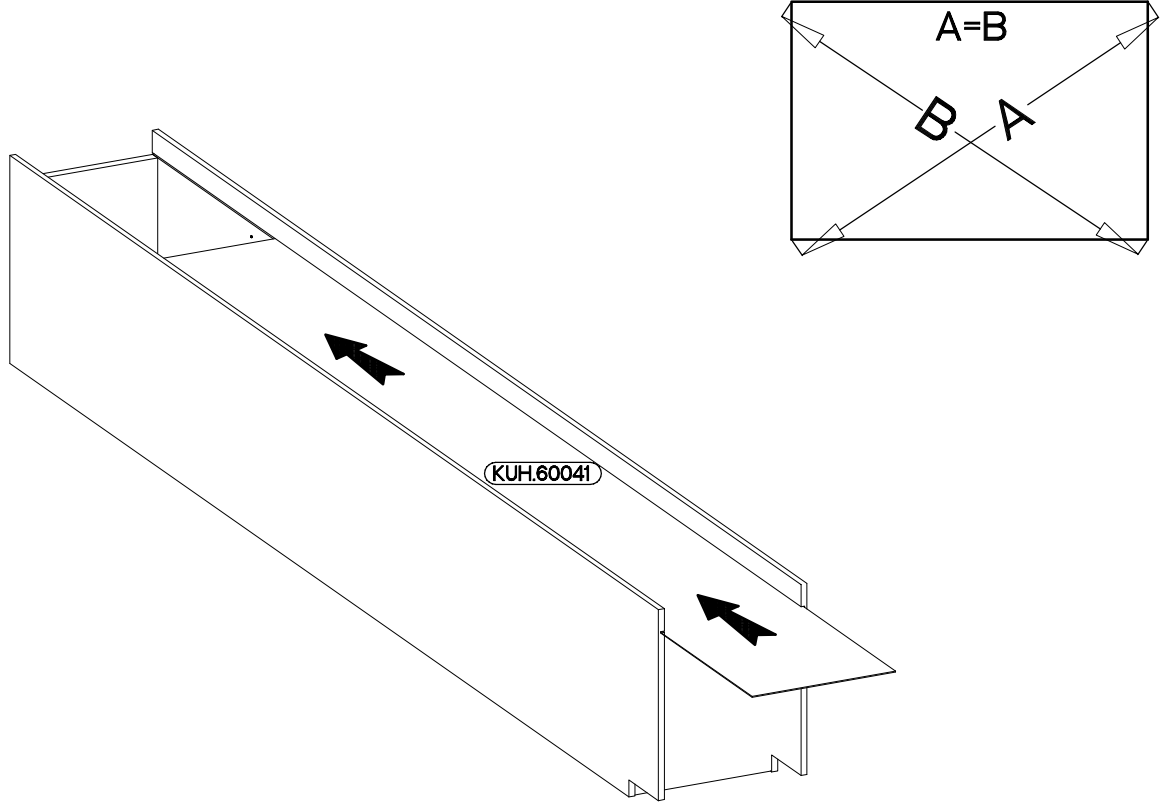

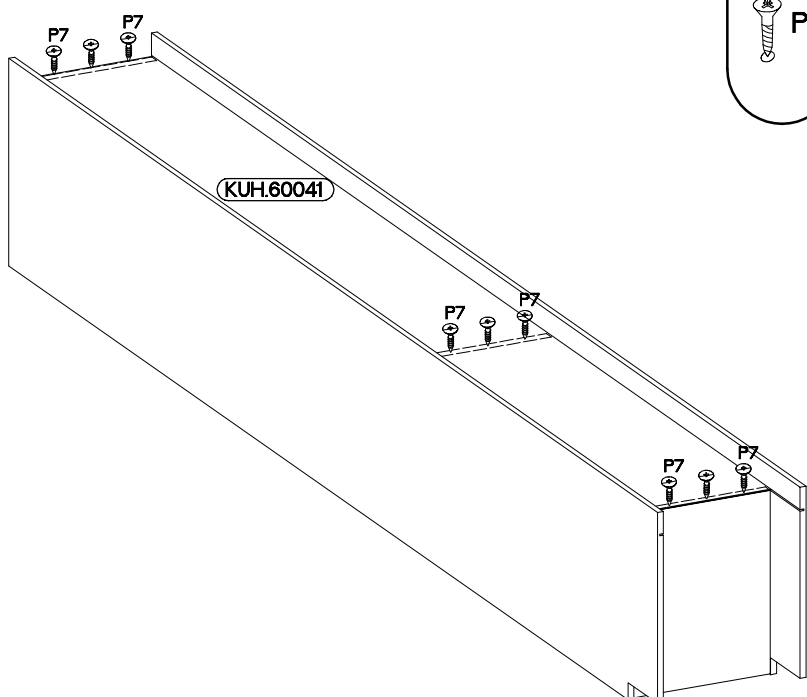
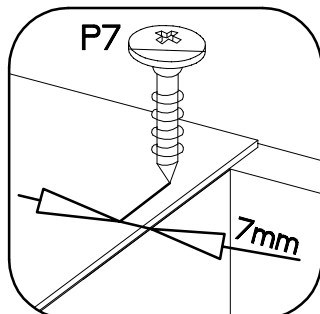
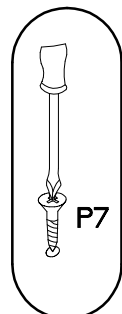

5

±3.0x20mm

P7
10-15

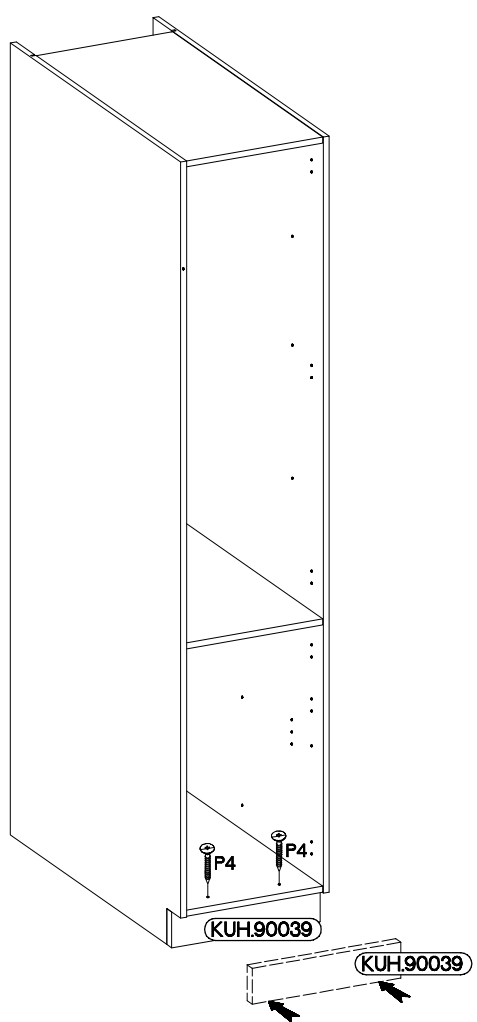
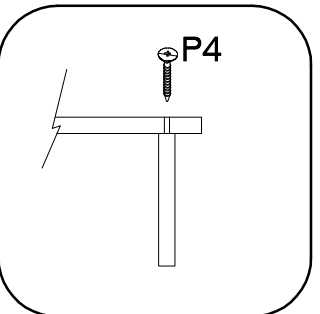
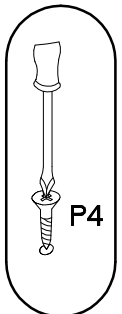

6

±4.0x45mm	
	E9
2	2



7

±5/19mm



J

16

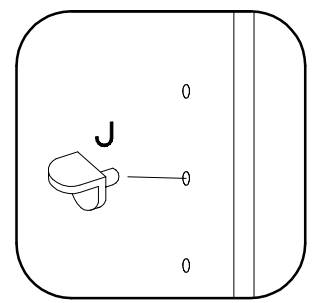
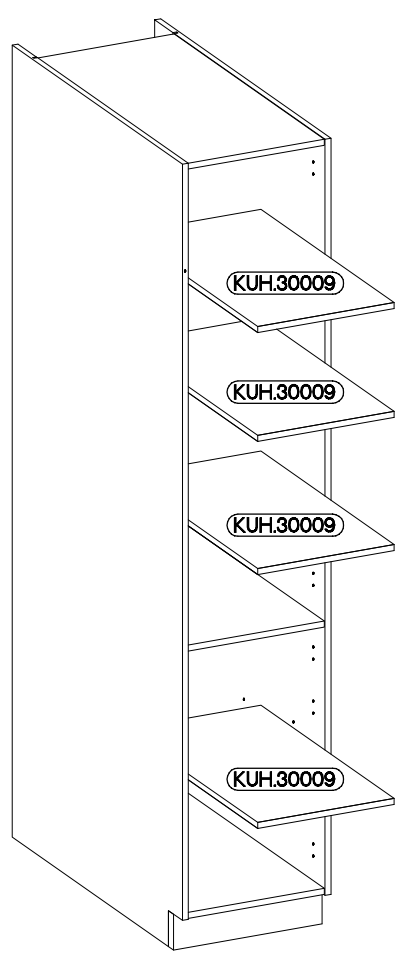

8

±3.5x13mm

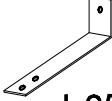

L25

1



P5

2

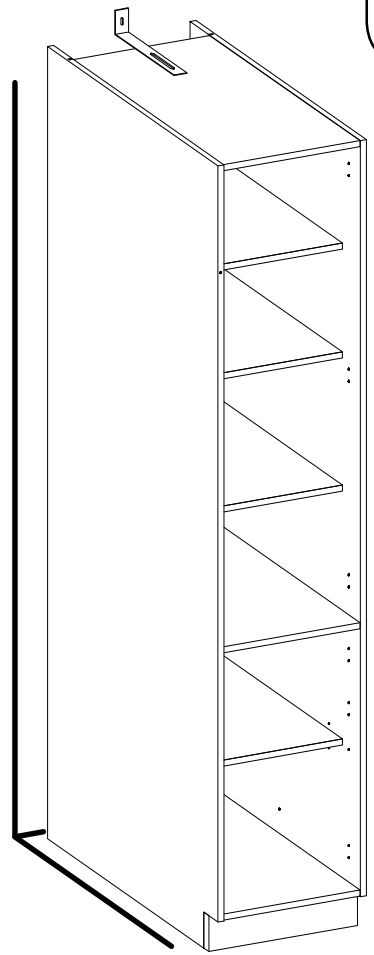

1.

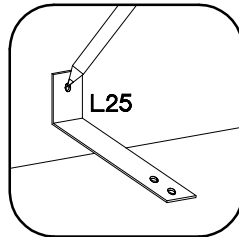

2.

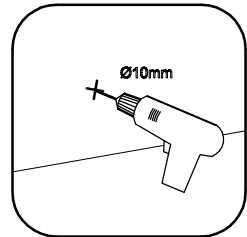

3.

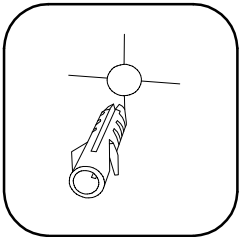

4.

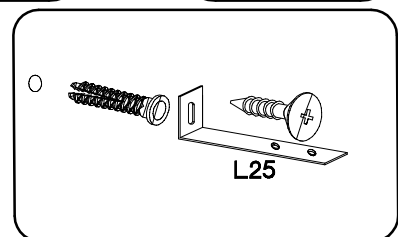

5.

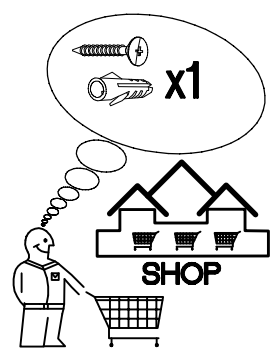
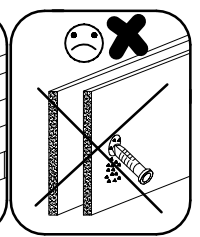
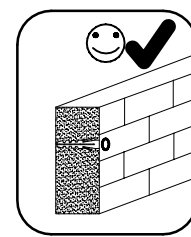
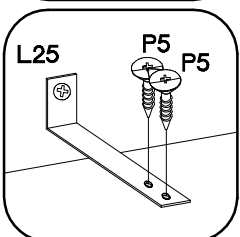

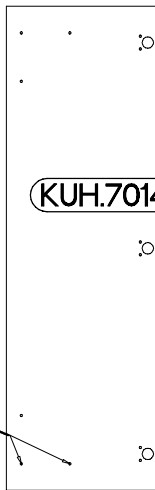
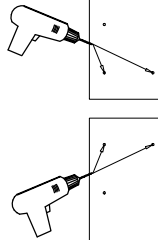
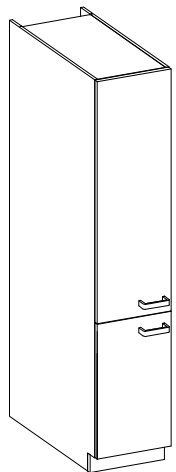

KUH.70140

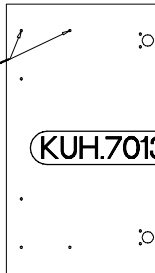

KUH.70138

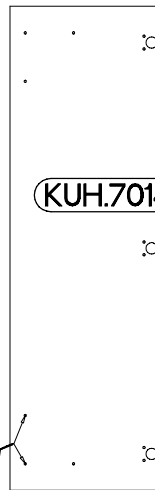
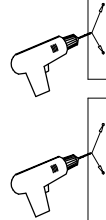
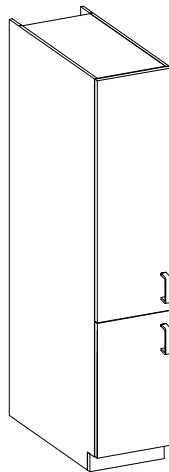

KUH.70140

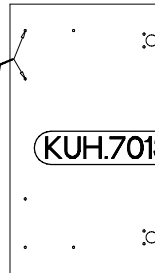

KUH.70138

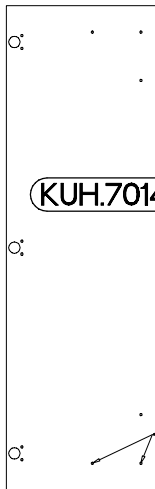
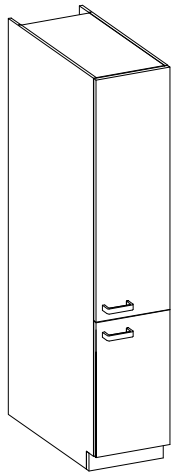
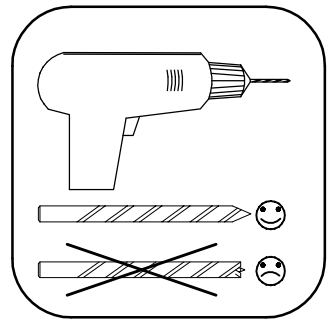

KUH.70140

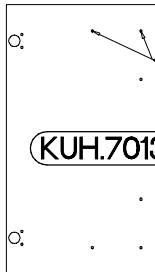

KUH.70138

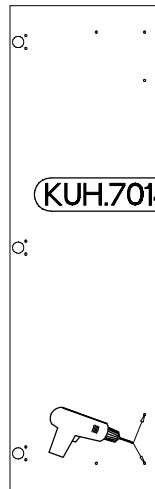
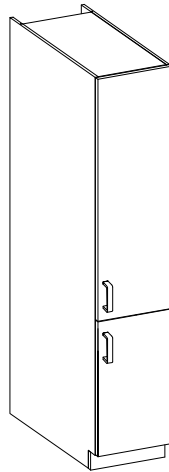



KUH.70140

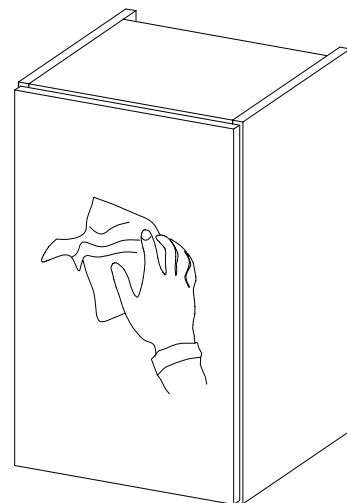
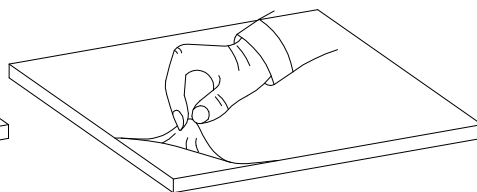
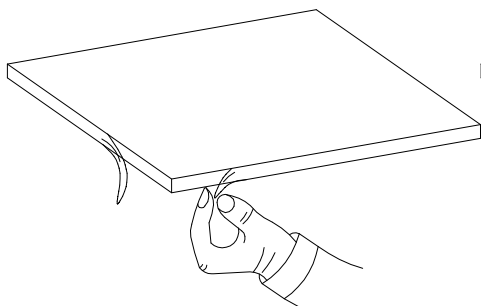
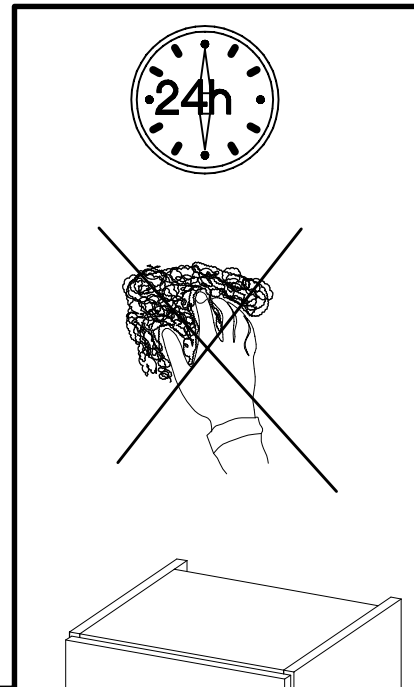
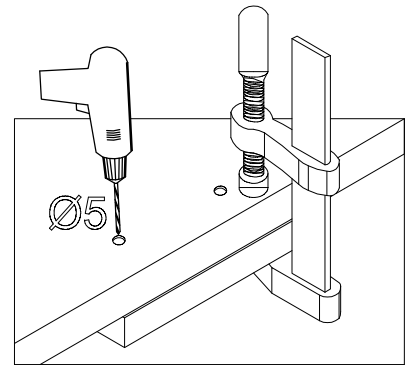

KUH.70138



M4x22mm		
4	U	S23
		2

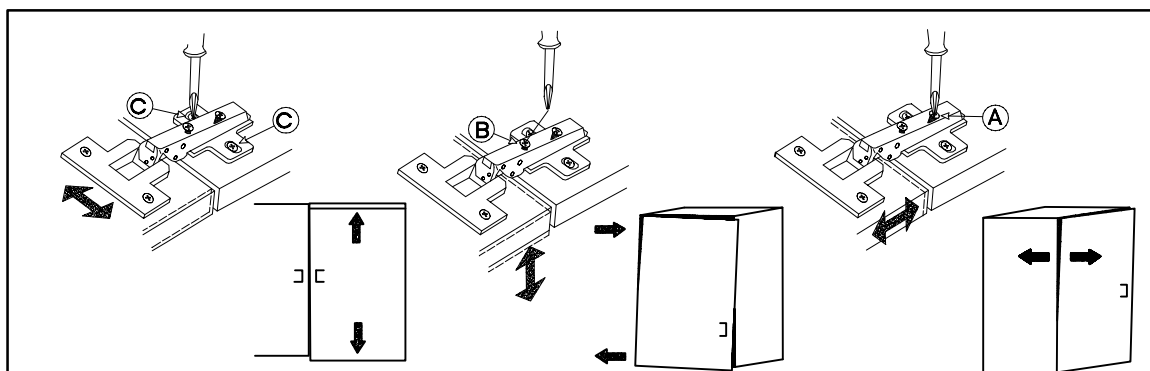
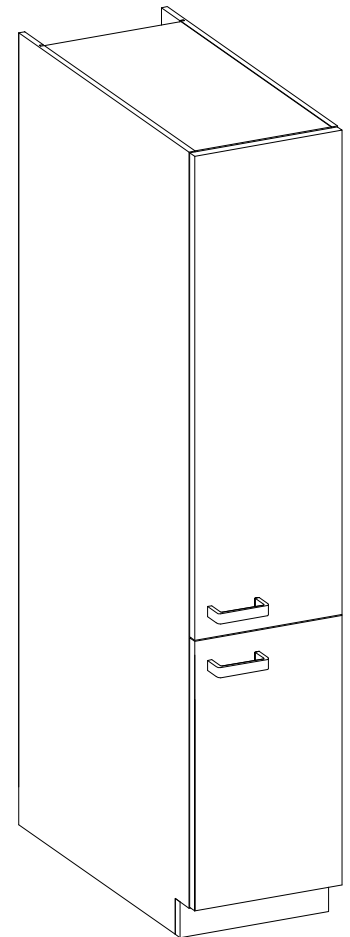
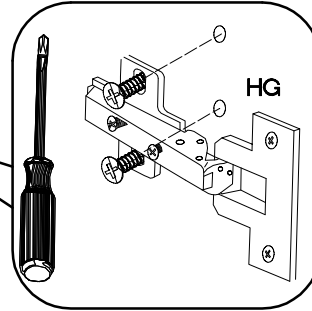
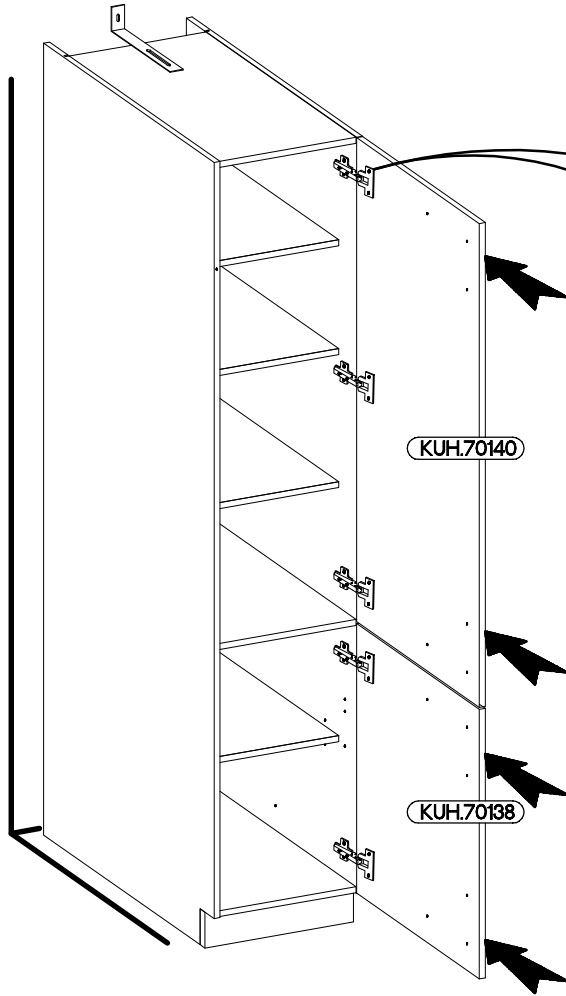
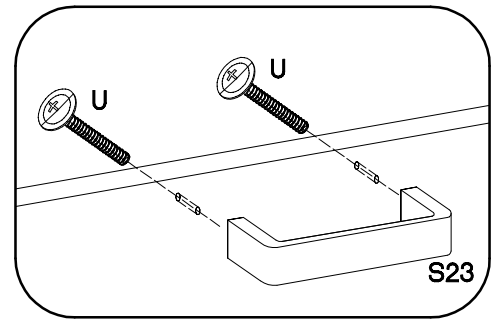

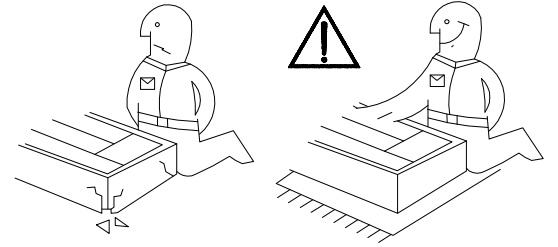
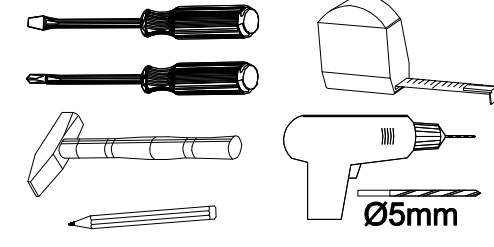
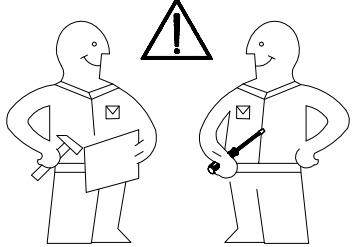

60 DK-2100 2F

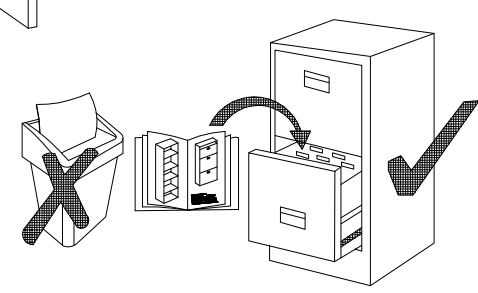
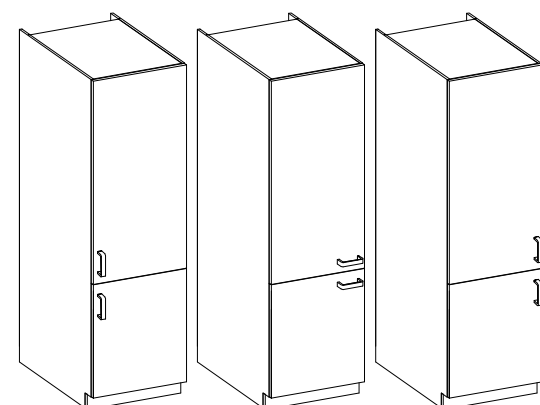
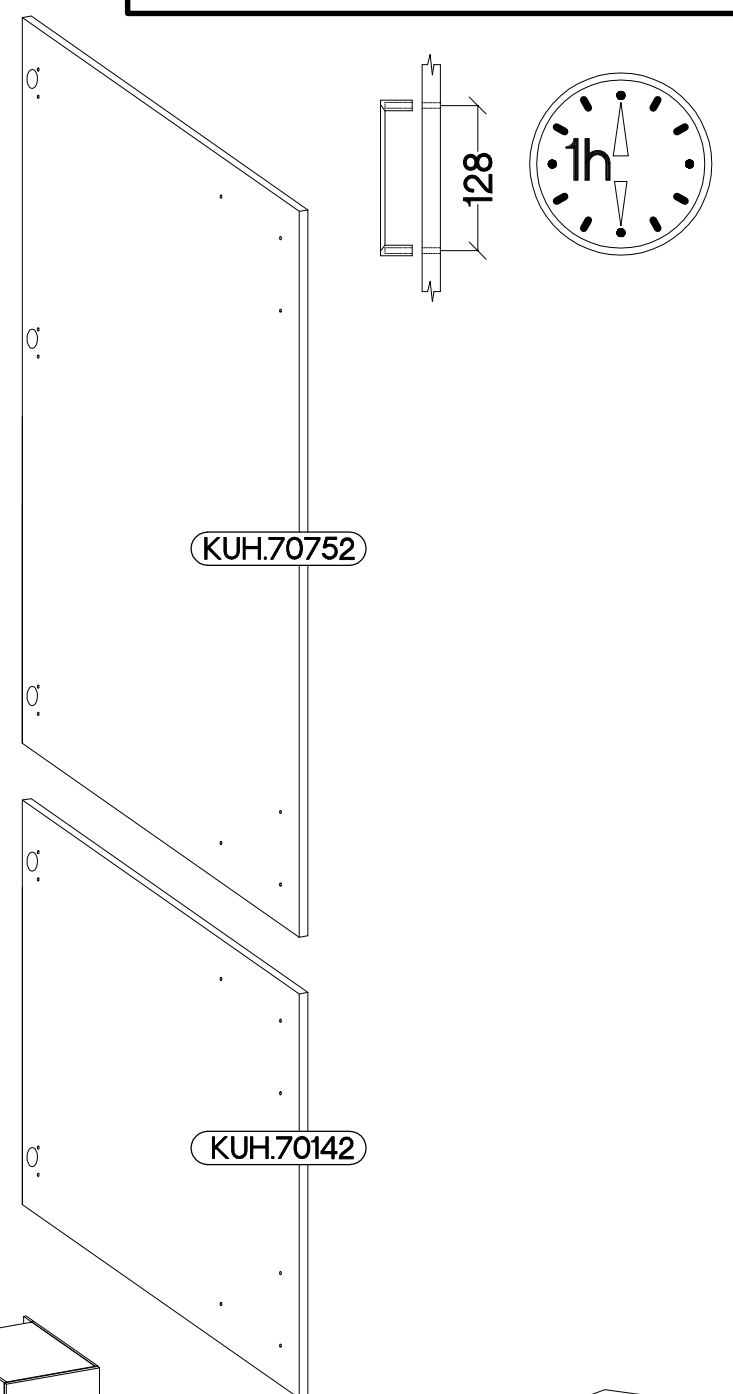
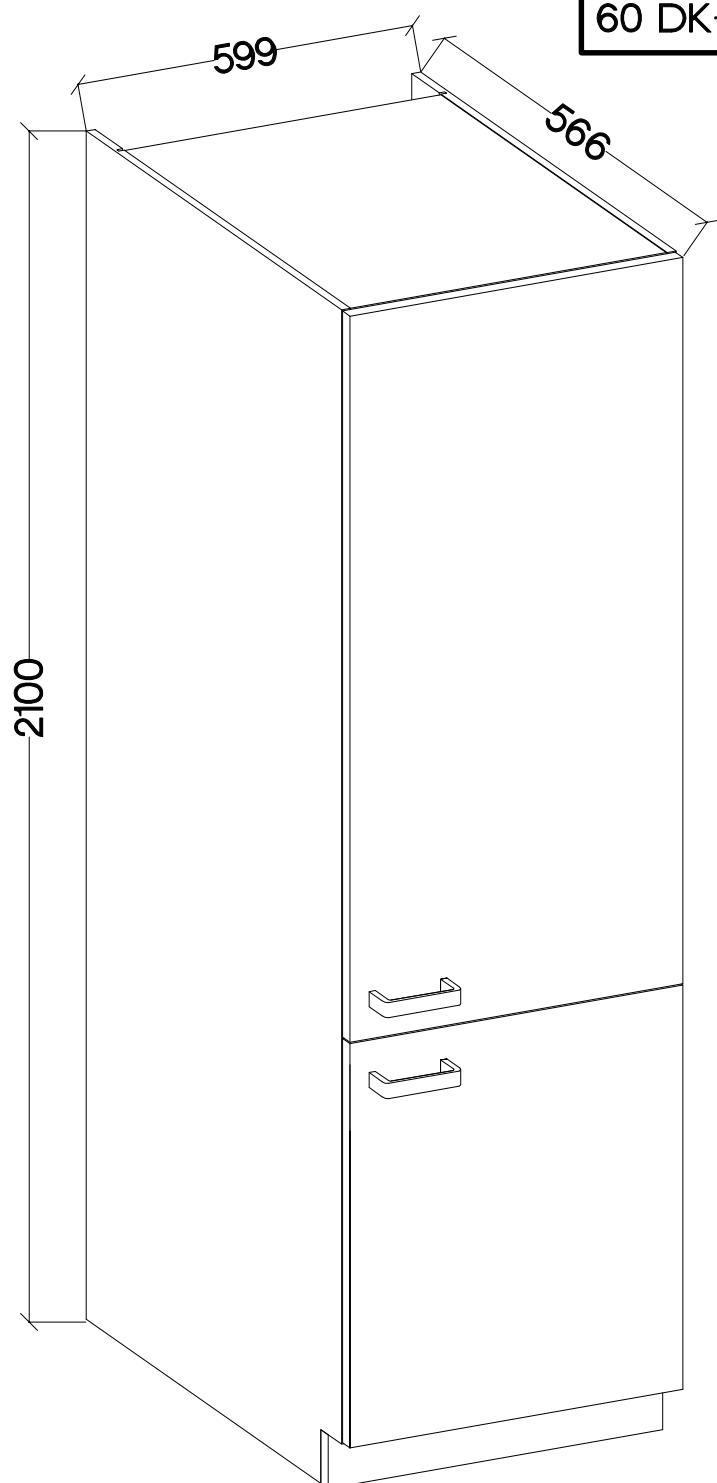
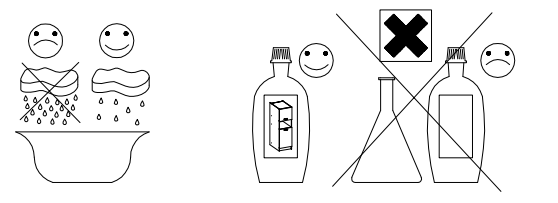

ISM-KUH-01104



1

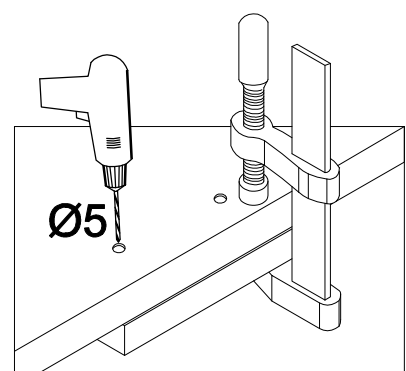
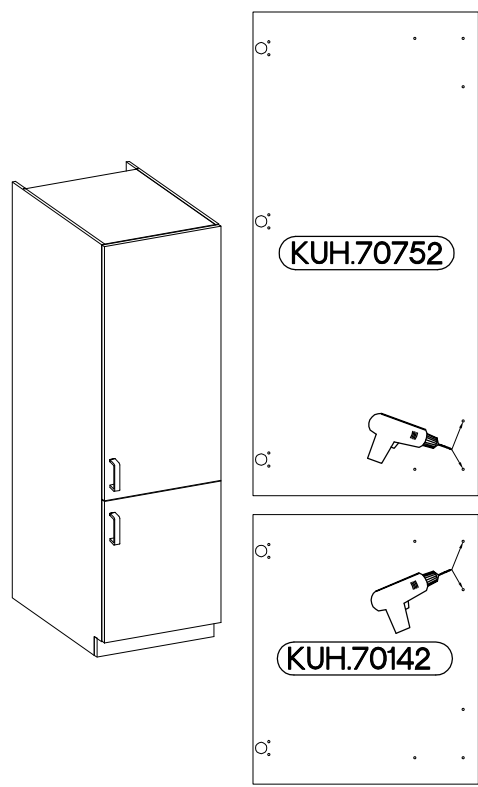
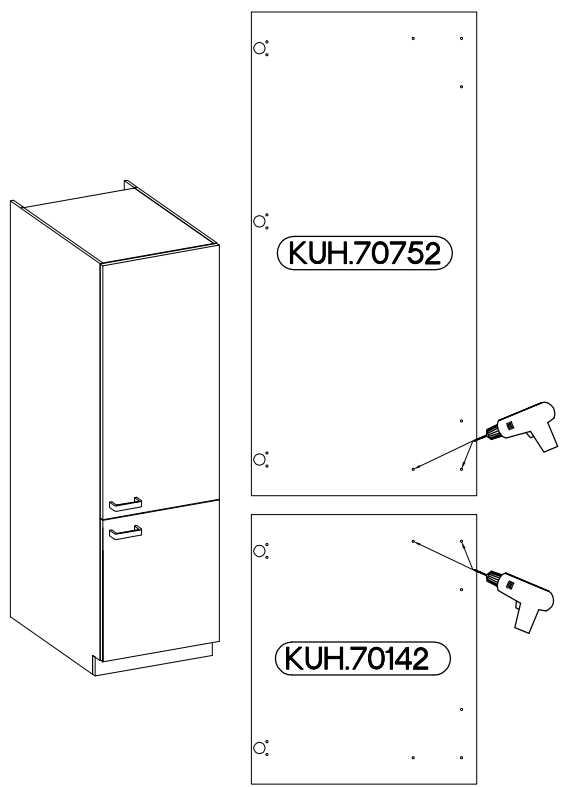
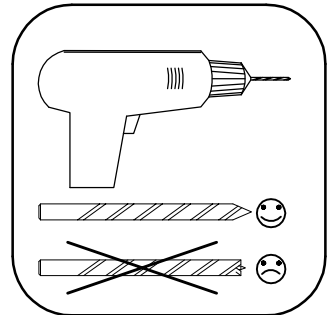
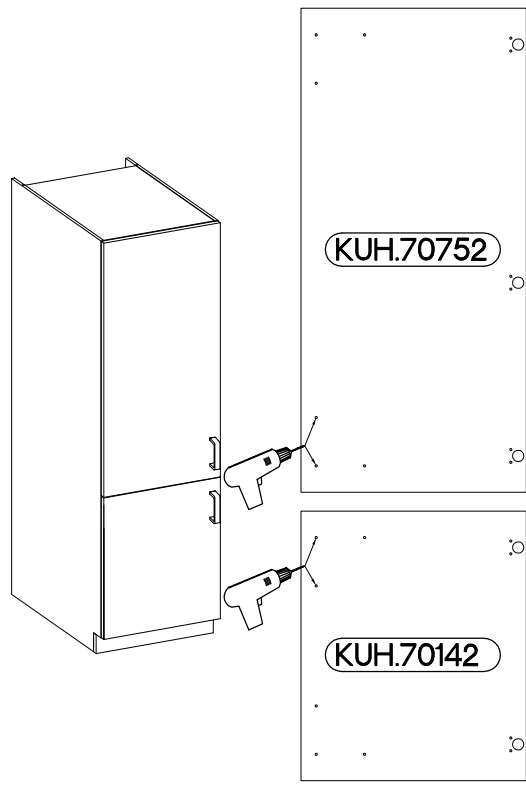
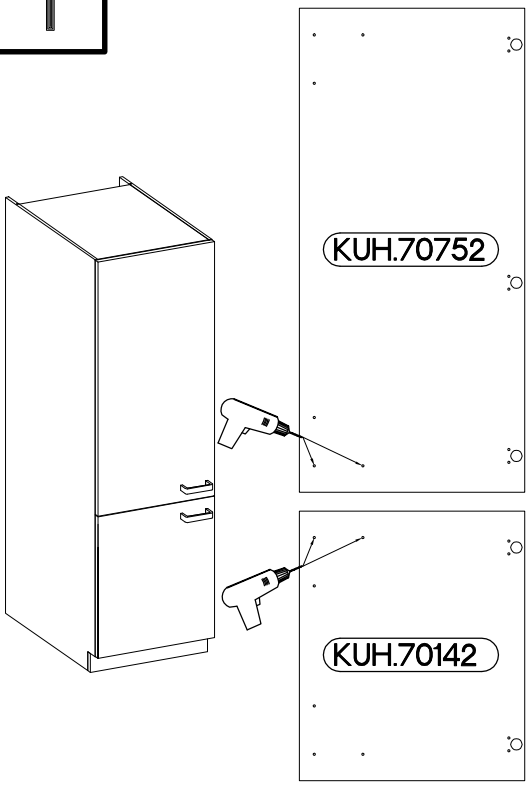

### VARIANT HIGH GLOSS

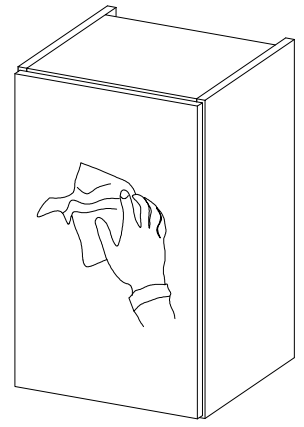
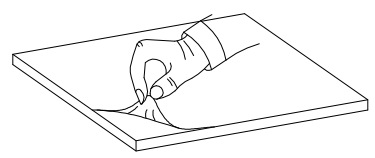
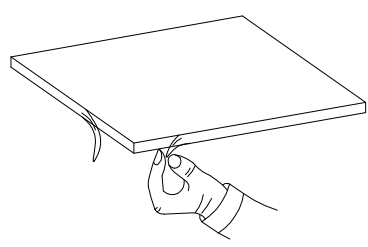

2

±35/0mm HG 4	±3.5x13mm P5 8
--------------------	----------------------

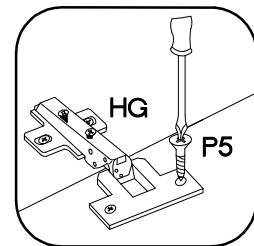
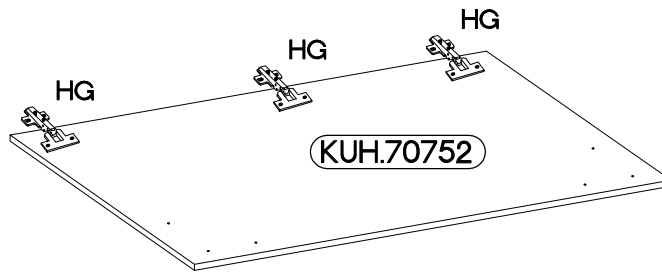
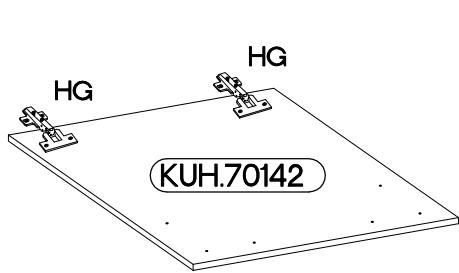

3

M4x22mm U 4	S23 2
-------------------	----------

