

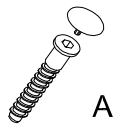











|  |  |  |  |  |  |  |  |  |  |  |  |  |
|--|--|--|--|--|--|--|--|--|--|--|--|--|
|  |  |  |  |  |  |  |  |  |  |  |  |  |
| 8  | 8  | 1  | 2  | 4  | 10-15  | 4  | 4  | 16   | 4  | 2  | 2  | 2  |

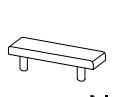
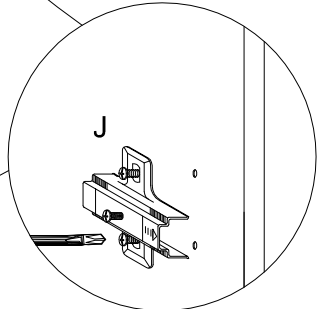
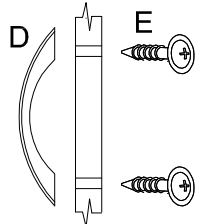
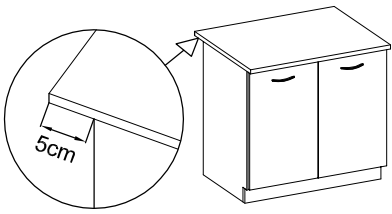
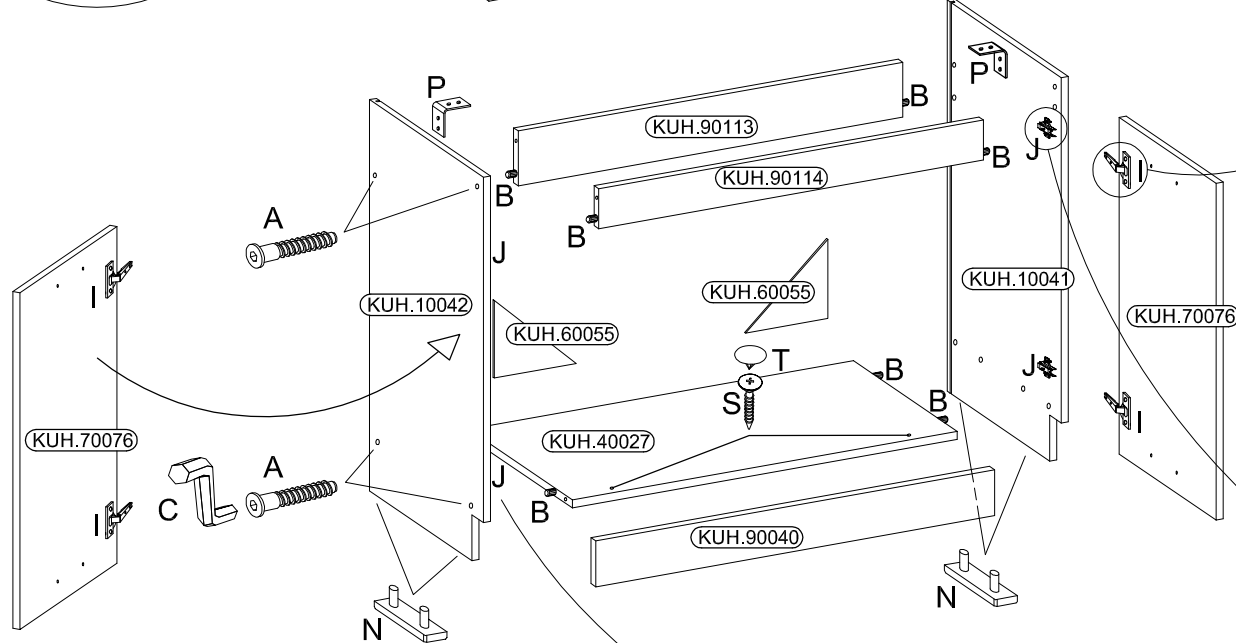
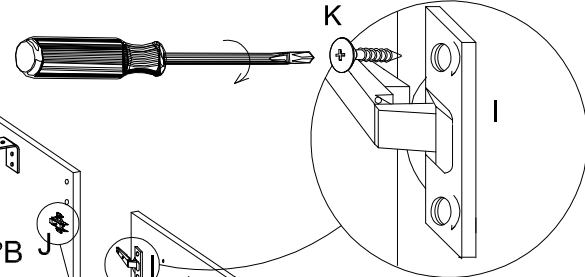
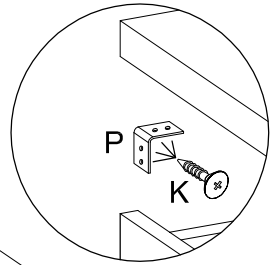
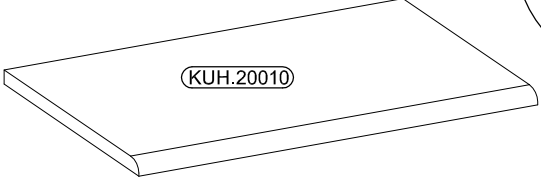
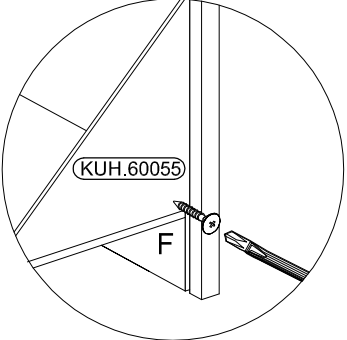
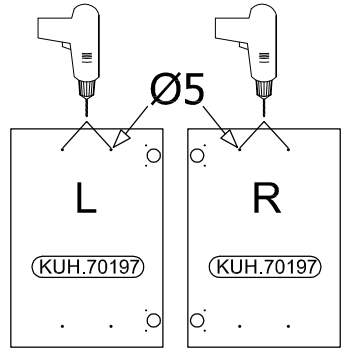
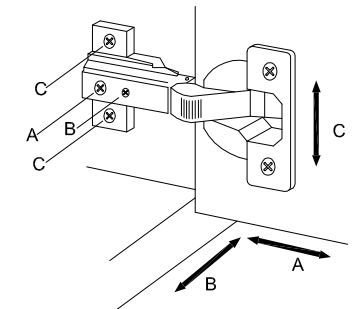
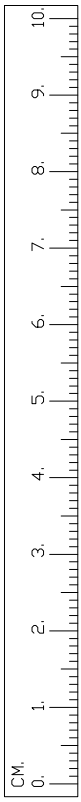
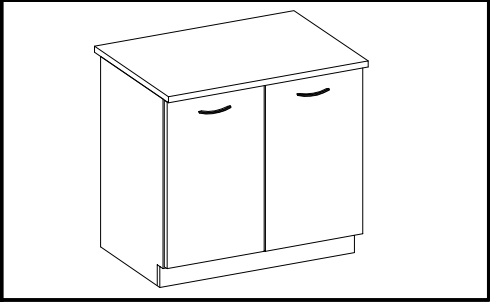

ISM-KUH-00501